

PLAT OF A SURVEY
 OF A TRACT OF LAND
 IN VIRGINIA MILITARY SURVEY 4399 & 4478,
 LAKE TOWNSHIP, CITY OF BELLEFONTAINE,
 LOGAN COUNTY, OHIO

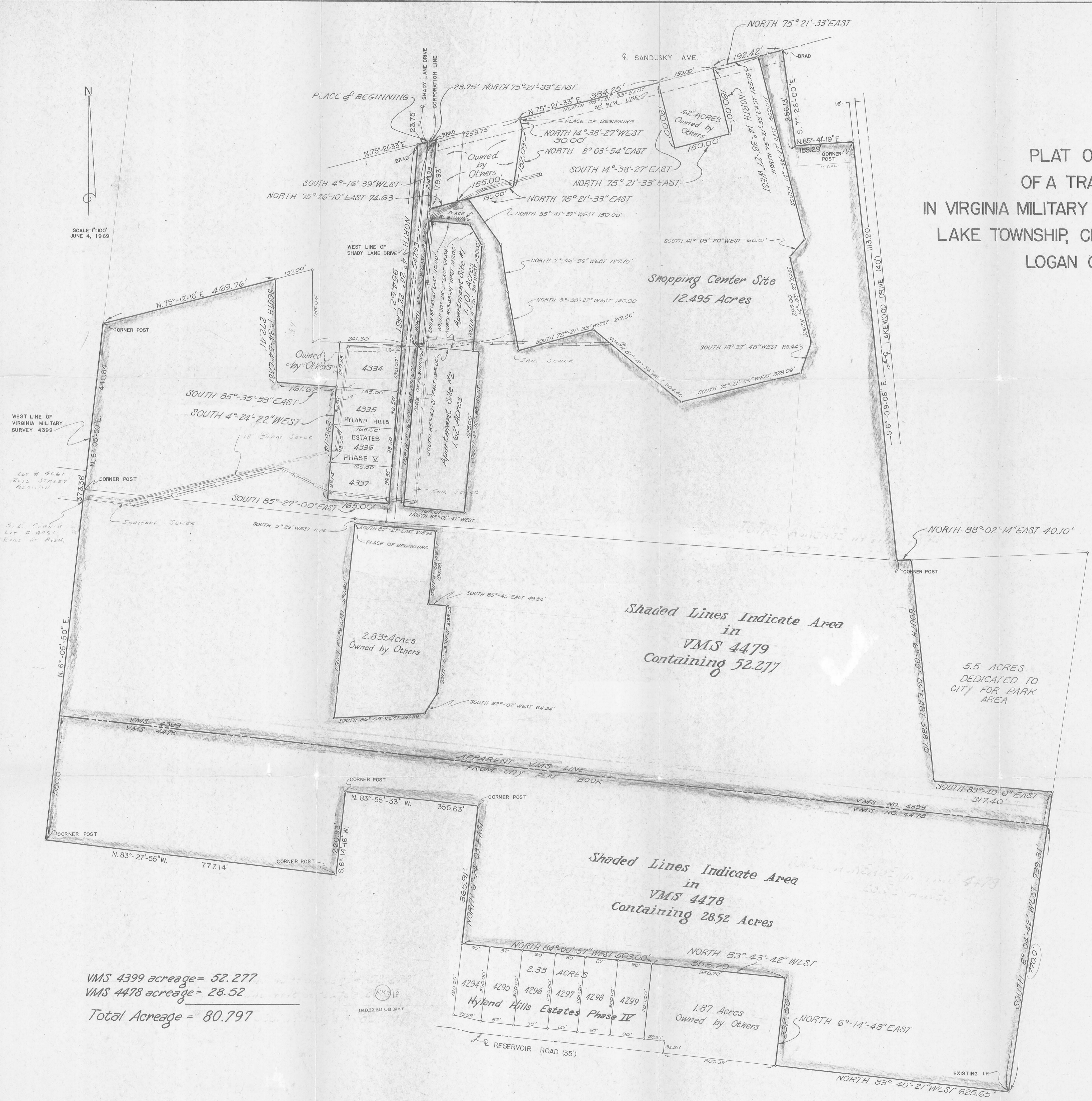

VMS 4399 acreage = 52.277
 VMS 4478 acreage = 28.52
 Total Acreage = 80.797

PREPARED FROM
 EXIST. RECORDS

BELLEFONTAINE LAND
 HOLDINGS By HYDRO-
 COMMERCIAL

THOMAS L. SHELDON P.E.
 REG. ENGINEER #32874
 REG. SURVEYOR #4620

SHELDON ENGINEERING
 LIMA, OHIO

REVISED 9/9/75 RLS
 REVISED 2/28/75 RLS
 REVISED 4/11/79 SLS
 6603

CONSULTING
CIVIL & SANITARY
ENGINEERS



1280

1280 NORTH COLE STREET • LIMA, OHIO 45801 • TELEPHONE 419-228-4421

December 20, 1979

DESCRIPTION
JOB #6603
42.03 Acre Parcel

Being a parcel of land situated in V.M.S. 4399 and V.M.S. 4478, Lake Township, Logan County, Ohio and being more particularly described as follows:

Beginning at the northwest corner of Lot 4294 as platted in Hyland Hills Estates Phase IV, this point being marked by an existing iron pin -

(1) Thence from this point of beginning north $6^{\circ}-26'-21''$ east, a distance of 373.98 feet to a steel fence corner post -

(2) Thence north $83^{\circ}-38'-06''$ west, a distance of 355.52 feet to a steel fence corner post -

(3) Thence south $6^{\circ}-30'-35''$ west, a distance of 222.30 feet to a wood corner post -

(4) Thence north $83^{\circ}-11'-45''$ west, a distance of 776.73 feet to a wood corner post -

(5) Thence north $6^{\circ}-14'-06''$ east, a distance of 817.29 feet to a concrete monument found, marking the southwest corner of an 8.95 acre tract of land -

Thence along the south lines of said 8.95 acre tract with the following 5 courses:

(6) South $83^{\circ}-45'-0''$ east, 180.59 feet to a concrete monument -

(7) North $6^{\circ}-36'-27''$ east, 10.00 feet to an iron pin -

(8) South $83^{\circ}-48'-43''$ east, 260.00 feet to an iron pin -

(9) South $74^{\circ}-50'-28''$ east, 199.87 feet to an iron pin -

6947 2D-1

INDEXED ON MAP

(10) South 85°-05'-06" east, 90.00 feet to an iron pin on the west side of a 2.83 acre tract of land -

Thence traversing said 2.83 acre tract with the following 6 courses:

(11) South 5°-47'-0" west, 400.30 feet -

(12) North 86°-23'-0" east, 241.89 feet -

(13) North 32°-25'-0" east, 64.64 feet -

(14) North 5°-41'-0" east, 233.55 feet -

(15) North 85°-27'-0" west, 49.34 feet -

(16) North 5°-12'-06" east, 194.09 feet -

(17) Thence south 87°-56'-40" east, a distance of 344.72 feet to an iron pin found for the southwest corner of a 4.17 acre tract -

(18) Thence south 86°-39'-0" east along said south line, a distance of 892.17 feet to a wood corner post -

(19) Thence north 87°-27'-11" east, a distance of 40.10 feet to the northwest corner of a 5.5 acre tract -

Thence along the west and south lines of said 5.5 acre tract with the following 2 courses:

(20) South 5°-46'-03" east, 588.70 feet -

(21) South 80°-40'-34" east, 317.40 feet to an existing iron pin -

(22) Thence south 8°-51'-49" west, a distance of 89.31 feet to the northwest corner of a 13.58 acre tract -

Thence along the lines of said 13.58 acre tract with the following 2 courses:

(23) North 83°-23'-08" west, 940.51 feet to an existing concrete monument -

(24) South 6°-26'-57" west, 481.44 feet to an existing concrete monument on the north line of a 1.87 acre tract -

6947 2D-2

Page #3 - Job #6603 - 42.03 acres - 12/20/79

(25) Thence north $84^{\circ}-12'-17''$ west, along said north line a distance of 69.41 feet to an existing iron pin on the northeast corner of Lot 4299 as platted in Hyland Hills Estates Phase IV -

(26) Thence north $84^{\circ}-00'-57''$ west along the north line of Hyland Hills Estates Phase IV, a distance of 509.11 feet to the point of beginning.

Containing 42.03 acres of land, (13.39 acres in V.M.S 4478 and 28.64 acres in V.M.S. 4399), subject to all easements and rights-of-way of record.

Note: All bearings refer to the north line of Hyland Hills Estates Phase IV as being north $84^{\circ}-00'-57''$ west.

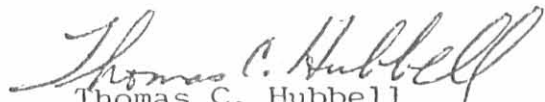
Thomas C. Hubbell
Reg. Surveyor #5044

TCH/sd

14132
 2D-3

INDEXED ON MAP

PLAT OF A SURVEY
OF A TRACT OF LAND
IN VIRGINIA MILITARY SURVEY 4399 & 4478,
LAKE TOWNSHIP, CITY OF BELLEFONTAINE,
LOGAN COUNTY, OHIO

SCALE: 1"=100'
JUNE 4, 1969

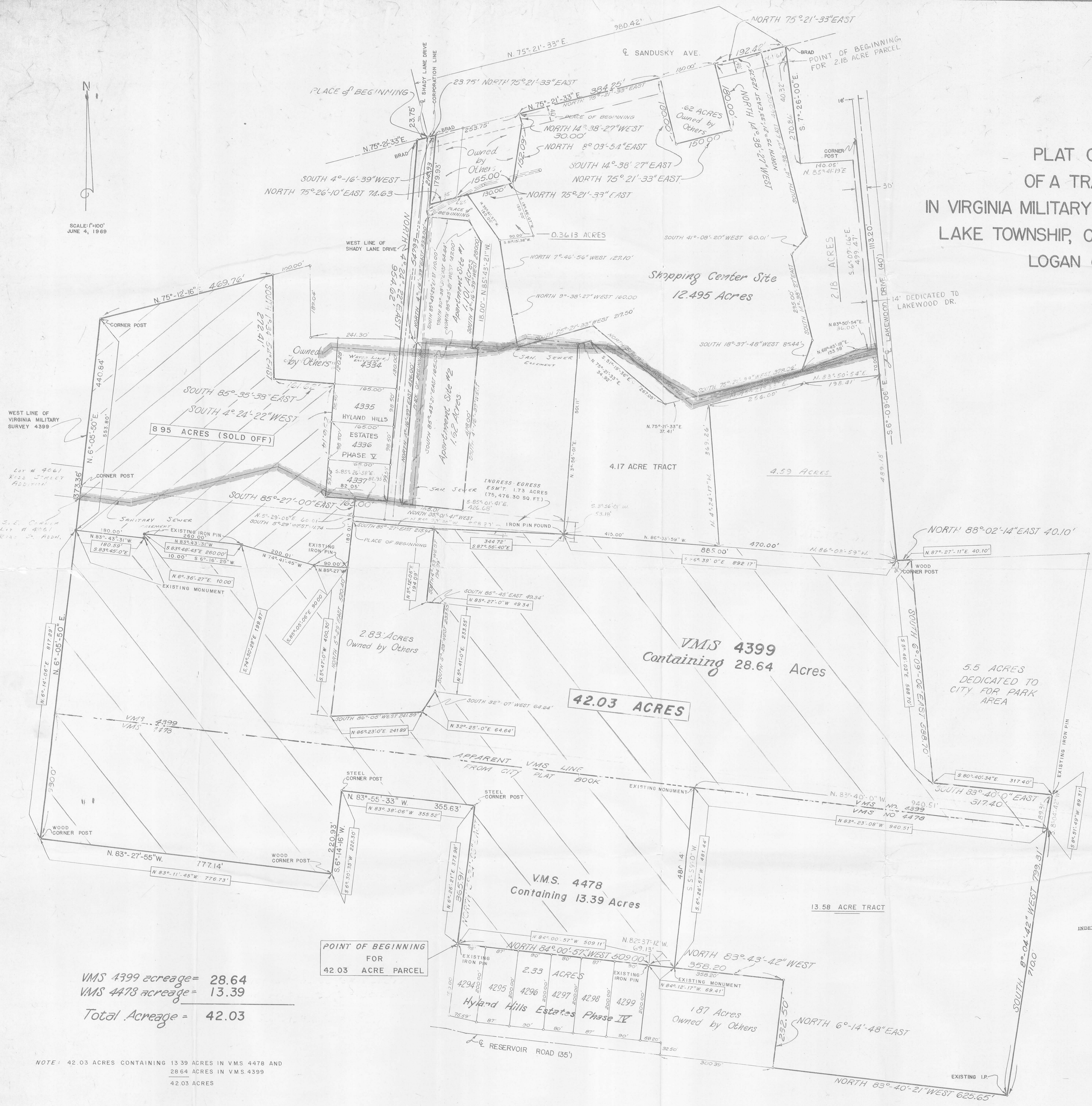

LEGEND
 WATER LINE EASEMENT
 SANITARY SEWER EASEMENT

PREPARED FROM
EXIST. RECORDS

BELLEFONTAINE LAND
HOLDINGS By HYDRO-
COMMERCIAL

THOMAS L. SHELDON P.E.
REG. ENGINEER #32874
REG. SURVEYOR #4620

INDEXED ON MAP

SHELDON ENGINEERING

LIMA, OHIO

REVISED 11/14/78 DRF - SOLD OFF 8.95 ACRES
 REVISED 3/21/78 DRF - TO SHOW 2.18 ACRE PARCEL & SHOW DEDICATION'S & CHECK OVERALL DRAWING AGAINST DESCRIPTION
 REVISED 6/7/77 SEB (CHANGED ACREAGE'S IN BOTH V.M.S. PARCELS AND ALSO ADDED 13.58 ACRE TRACT)
 REVISED 5/16/77 SEB (ADD 4.17 AC. TRACT)
 REVISED 12/1/76 C.H. SHOW EASEMENT
 REVISED 10/23/76 SEB
 Revised 4/8/75 RALPH
 REVISED 2/28/75 RALPH
 REVISED 4/11/71 SEB

VMS 4399 acreage = 28.64
 VMS 4478 acreage = 13.39
 Total Acreage = 42.03

NOTE: 42.03 ACRES CONTAINING 13.39 ACRES IN VMS 4478 AND 28.64 ACRES IN VMS 4399
 42.03 ACRES

(CROSS HATCHED) DENOTES 42.03 ACRES
 Bearing, Distance DENOTES FIELD SURVEY (42.03 ACRES) AS OF DECEMBER, 1979

REVISED: DECEMBER, 1979 DRF TO SHOW 42.03 ACRE PARCEL

6603

1 OK JUD

City of Bellefontaine, Ohio Utility Easement I

The following described non exclusive utility easement situated in the State of Ohio, County of Logan, Township of Lake, City of Bellefontaine, being part of V.M.S. 4399 & 4478, and more particularly described as follows:

Beginning for reference at a concrete monument found at the southwest corner of Ashbrook Drive as shown on the plat of Deer Run No. 1 as recorded in Plat Cabinet A, Slides 691 A & B, 693 A, of the Logan County Recorders Office,

Thence with the south line of said Ashbrook Drive S.79°-08'-40"E. 30.00 feet to a point in the centerline of said road, said point being the true place of beginning of this easement's centerline description with the full easement being 60.00 feet wide, 30.00 feet on each side of this centerline description.

Thence S.10°-51'-20"W. 26.32 feet to a point,

Thence with a curve to the left having a radius of 150.00 feet, a central angle of 89°-27'-56", and arc length of 234.22 feet, a chord bearing and length of S,33°-52'-38"E. 211.14 feet to a point,

Thence S.78°-36'-36"E. 276.67 feet to a point,

Thence with a curve to the left having a radius of 150.00 feet, a central angle of 60°-00'-00", an arc length of 157.08 feet, a chord bearing and length of N.71°-23'-24"E. 150.00 feet to a point,

Thence N.41°-23'-24"E. 118.65 feet to a point,

Thence with a curve to the right having a radius of 150.00 feet, a central angle of 59°-27'-27", an arc length of 155.66 feet, a chord bearing and length of N.71°-07'-08"E. 148.77 feet to a point,

Thence S.79°-09'-09"E. 135.87 feet to a point,

Thence with a curve to the right having a radius of 150.00 feet, a central angle of 35°-00'-00", an arc length of 91.63 feet, a chord bearing and length of S.61°-39'-09"E. 90.21 feet to a point,

Thence S.44°-09'-09"E. 100.03 feet to a point,

Thence with a curve to the left having a radius of 193.00 feet, a central angle of 49°-02'-42", an arc length of 165.20 feet, a chord bearing and length of S.68°-40'-30"E. 160.21 feet to a point,

Thence continuing with a curve to the left having a radius of 840.54 feet, a central angle of 29°-03'-25", an arc length of 426.27 feet, a chord bearing and length of N.72°-16'-26"E. 421.72 feet to a point,

Thence N.57°-44'-44"E. 666.44 feet to a point in the west line of the proposed Ashbrook Drive and there terminate, said point being in the east line of the Hills & Dales Partnership's 41.644 acre tract as is recorded in O. R. Vol. 72, Page 893 (Tract II) and in the west line of the City of Bellefontaine, Ohio's 5.500 acre tract as is recorded in D. B. Vol. 338, Page 814, said point being S.1°-10'-31"E. (this bearing is assumed and all other bearings and distances are as measured by this survey) 60.78 feet from a 5/8 inch iron bar found at the northwest corner of said 5.500 acre tract. The above 60.00 foot utility easement being part of the Hills and Dales Partnership's 41.644 acre tract as described in O. R. Vol. 72, Pg. 893.

This description prepared from an actual field survey performed by Timothy L. Notestine, P.S. #S-7815 on August 8, 1997.



Timothy L. Notestine, P.E., P.S.
135 North Detroit Street
Bellefontaine, Ohio 4331



INDEXED ON MAP
6947 3D-1

1029m

City of Bellefontaine, Ohio - Utility Easement II

The following described non exclusive utility easement situated in the State of Ohio, County of Logan, Township of Lake, City of Bellefontaine, being part of V.M.S. 4399, being a part of the Hills & Dales Partnership's 41.644 acre tract as is described in O. R. 72 Page 893 (Tract II), and more particularly described as follows:

Beginning for reference at a 5/8 inch iron bar found at the southwest corner of the City of Bellefontaine, Ohio's 5.500 acre tract as is described in D. B. Volume 338, Page 814, said iron bar also being in the east line of said 41.644 acre tract,

Thence with said the west line of said 5.500 acre tract and the east line of said 41.644 acre tract N.01°-10'-31"W. (this bearing is assumed and all other bearings and distances are as measured by this survey) 97.04 feet to a concrete monument found at the true point of beginning of this description in the proposed south right-of-way line of Scenic Hill Court,

Thence with the said proposed right-of-way line the following six bearings and distances:

1. S.88°-49'-29"W. 46.93 feet to a point,
2. With a curve to the left having a radius of 25.00 feet, a central angle of 83°-47'-45", an arc length of 36.56 feet, a chord bearing and length of S.46°-55'-36"W. 33.39 feet to a point,
3. With a curve to the right having a radius of 50.00 feet, a central angle of 233°-32'-37", an arc length of 203.81 feet, a chord bearing and length of N.58°-11'-56"W. 89.28 feet to a point,
4. N.58°-34'-21"E. 25.00 feet to a point,
5. With a curve to the right having a radius of 155.00 feet, a central angle of 30°-15'-08", an arc length of 81.84 feet, a chord bearing and length of N.73°-41'-55"E. 80.89 feet to a point,
6. N.88°-49'-29"E. 47.00 feet to a concrete monument found,

Thence with the west line of said 5.500 acre tract S.01°-10'-31"E. 60.00 feet to the place of beginning.

This description prepared from an actual field survey performed by Timothy L. Notestine, P.S. #S-7815 on August 8, 1997.



Timothy L. Notestine, P.E., P.S.,
135 N. Detroit Street
Bellefontaine, Ohio 43311

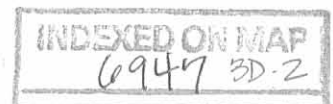

City of Bellefontaine, Ohio - Utility Easement III

The following described non exclusive utility easement situated in the State of Ohio, County of Logan, Township of Lake, City of Bellefontaine, being part of V.M.S. 4399, being part of the Hills & Dales Partnership's 41.644 acre tract as is described in O. R. 72 Page 893, and more particularly described as follows:

Said easement being 10.00 feet in width and being immediately north of and parallel to the following described line,

Beginning at a 5/8 inch iron bar found at the southeast corner of said 41.644 acre tract and at the northeast corner of Lot No. 4558 of Glenwood East Allotment II as recorded in Plat Cabinet A, Slide 695-B of the Logan County Recorders Office,

Thence, with the north line of Glenwood East Allotment No. II, N.79°-19'-44"W. (this bearing is assumed) 201.13 feet to a 5/8 iron bar found at the northeast corner of Lakewood Drive, also being the northwest corner of Lot. No. 4559 as shown on said Allotment and there terminate.

This description prepared from an actual field survey performed by Timothy L. Notestine, P.S. #S-7815 on August 8, 1997.

Timothy L. Notestine

Timothy L. Notestine, P.E., P.S.
135 N. Detroit Street
Bellefontaine, Ohio 43311



INDEXED ON MAP
6947 3D-3

02/07/17

City of Bellefontaine, Ohio Utility Easement IV

The following described non exclusive utility easement situated in the State of Ohio, County of Logan, Township of Lake, City of Bellefontaine, being a part of V.M.S. 4399 and more particularly described as follows:

Beginning for reference at a 5/8 inch iron bar found at the southwest corner of the City of Bellefontaine, Ohio's 5.500 acre tract as is described in D. B. Vol. 338, Page 814 and also being in the east line of the Hills and Dales Partnership's 41.644 acre tract as is described in O. R. Vol. 72, Pg. 893,

Thence, with said the east line of said 41.644 acre tract and the west line of said 5.500 acre tract N.01°-10'-31"W. (said east line bearing being assumed and all other distances and bearings are as measured by this survey) 238.04 feet to a point at the true place of beginning of this easement's centerline description. The full easement being 10.00 feet wide, 5.00 feet on each side of this centerline description,

Thence, N.88°-49'-29"E. 40.00 feet to a point in the west line of the proposed Lakewood Drive and there terminate.

The above 10.00 feet utility easement being part of the City of Bellefontaine, Ohio's 5.500 acre tract as is described in D. B. Vol. 338, Pg. 814.

This description prepared from an actual field survey performed by Timothy L. Notestine, P.S. #S-7815 on August 8, 1997.



TIMOTHY L. NOTESTINE, P.E., P.S.,
135 NORTH DETROIT STREET
BELLEFONTAINE, OHIO 43311

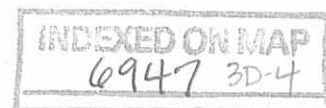

CITY OF BELLEFONTAINE, OHIO UTILITY EASEMENT SURVEY

SITUATED IN V.M.S. 4399 & 4478, CITY OF BELLEFONTAINE,
LAKE TOWNSHIP, LOGAN COUNTY, OHIO

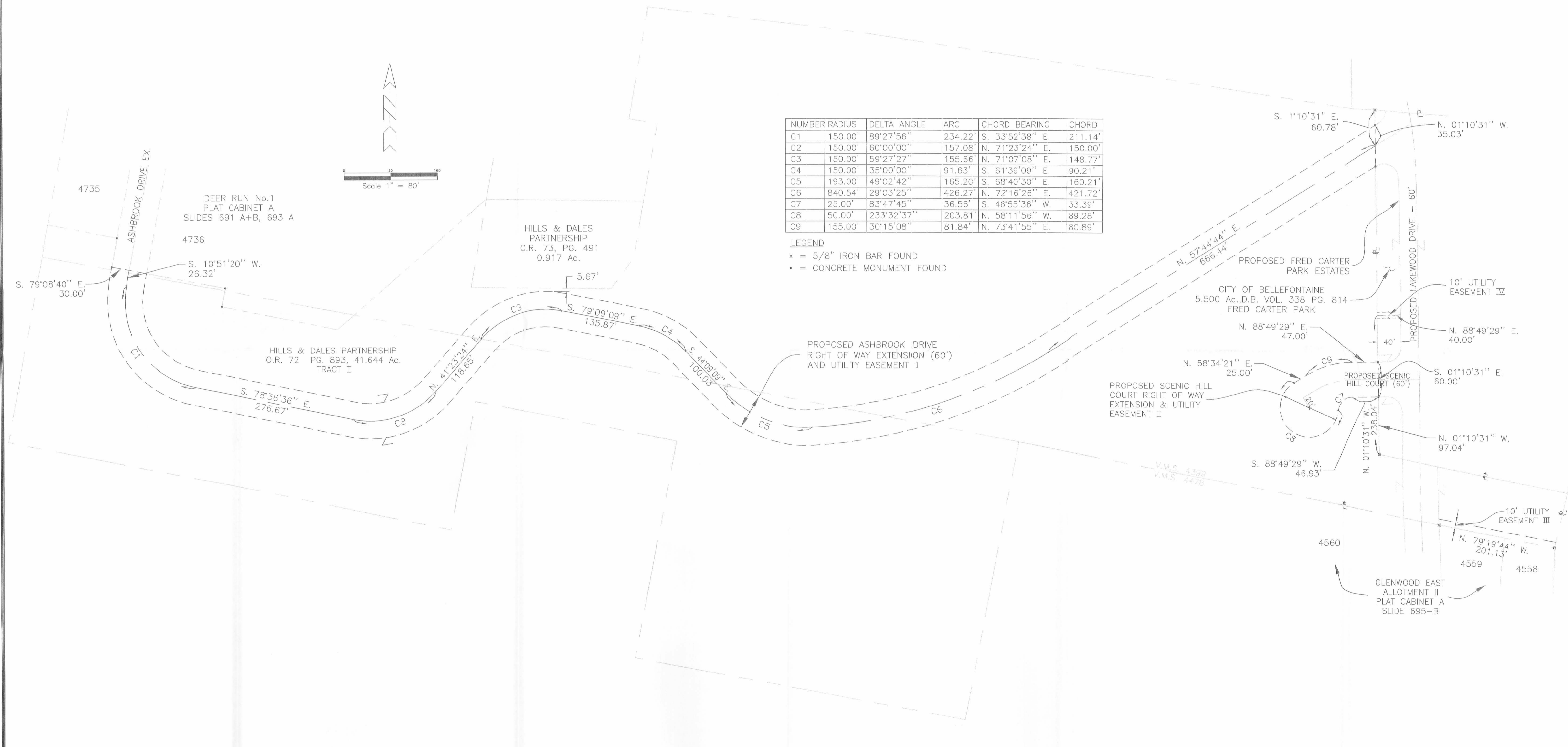

NUMBER	RADIUS	DELTA ANGLE	ARC	CHORD BEARING	CHORD
C1	150.00'	89°27'56"	234.22'	S. 33°52'38" E.	211.14'
C2	150.00'	60°00'00"	157.08'	N. 71°23'24" E.	150.00'
C3	150.00'	59°27'27"	155.66'	N. 71°07'08" E.	148.77'
C4	150.00'	35°00'00"	91.63'	S. 61°39'09" E.	90.21'
C5	193.00'	49°02'42"	165.20'	S. 68°40'30" E.	160.21'
C6	840.54'	29°03'25"	426.27'	N. 72°16'26" E.	421.72'
C7	25.00'	83°47'45"	36.56'	S. 46°55'36" W.	33.39'
C8	50.00'	233°32'37"	203.81'	N. 58°11'56" W.	89.28'
C9	155.00'	30°15'08"	81.84'	N. 73°41'55" E.	80.89'

LEGEND
 ■ = 5/8" IRON BAR FOUND
 • = CONCRETE MONUMENT FOUND

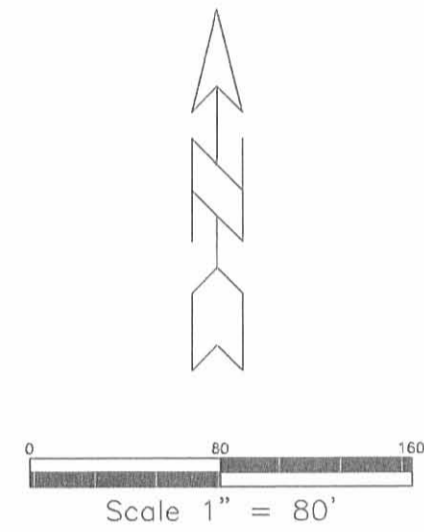

4735
 ASHBROOK DRIVE EX.
 DEER RUN No.1
 PLAT CABINET A
 SLIDES 691 A+B, 693 A

HILLS & DALES
 PARTNERSHIP
 O.R. 73, PG. 491
 0.917 Ac.

HILLS & DALES PARTNERSHIP
 O.R. 72 PG. 893, 41.644 Ac.
 TRACT II

CITY OF BELLEFONTAINE
 5.500 Ac., D.B. VOL. 338 PG. 814
 FRED CARTER PARK

PROPOSED SCENIC HILL
 COURT RIGHT OF WAY
 EXTENSION & UTILITY
 EASEMENT II

GLENWOOD EAST
 ALLOTMENT II
 PLAT CABINET A
 SLIDE 695-B

Timothy L. Notestine
 TIMOTHY L. NOTESTINE P.E., P.S.
 135 N. DETROIT ST.
 BELLEFONTAINE, OHIO 43311
 SURVEY DATE: 8-8-97



INDEXED ON MAP
 6947 3P

HILL'S & DALE'S PARTNERSHIP SURVEY

RIGHT-OF-WAY TRACT

The following described real estate situated in the State of Ohio, County of Logan, Township of Lake, City of Bellefontaine, being a part of V.M.S. 4399, and more particularly described as follows:

Beginning for reference at a 5/8 inch iron bar found at the southwest corner of the City of Bellefontaine, Ohio's 5.500 acre tract as is described in D. B. Vol. 338, Page 814, and also being in a line of the Hill's and Dale's Partnership's 41.644 acre tract as is described in O. R. Vol. 72, Page 893, Tract II,

Thence with a line of said 41.644 acre tract S.78°-40'-46"E. 40.97 feet to a concrete monument found in the proposed west right-of-way line of Lakewood Drive at the true place of beginning of this description.

Thence with the south line of said 5.500 acre tract, S.78°-40' -46"E. 61.46 feet to a concrete monument found in the proposed east right-of-way line of Lakewood Drive,

Thence with said proposed east right-of-way line of Lakewood Drive S.1°-10'-31"E. (said east line bearing being assumed and all other distances and bearings are as measured by this survey) 55.27 feet to a concrete monument found,

Thence continuing with said proposed east right-of-way line on a 570.00 foot radius curve to the left having a central angle of 1°-33'-34", an arc length of 15.51 feet, a chord bearing and length of S.1°-57'-18"E. 15.51 feet to a concrete monument found,

Thence continuing with said proposed east right-of-way line S.2°-44'-05"E. 28.18 feet to a 5/8 inch iron bar found at the northwest corner of lot 4559, as shown on the recorded plat of Glenwood East Allotment II, as is recorded in Plat Cabinet A, Slide 695-B in the Logan County Recorders Office, and being the north line of V.M.S. 4478,

Thence with the north line of said V.M.S. 4478 and the aforementioned subdivision, and the existing Lakewood Drive right-of-way line, N.79°-19'-44"W. 61.68 feet to a concrete monument found at the northwest corner of lot 4560 of said subdivision,

Thence, with the proposed west right-of-way line of Lakewood Drive N.2°-44'-05"W. 13.87 feet to a concrete monument found,

Thence, continuing with said west right-of-way line, with a curve to the right, having a radius of 630.00 feet, a central angle of 1°-33'-34", an arc length of 17.15 feet, a chord bearing and length of N.1°-57'-18"W. 17.15 feet, to a concrete monument found,

Thence, continuing with said proposed west right-of-way line N.1°-10'-31"W. 68.57 feet to the place of beginning.

Containing 0.137 acres, more or less, and being a portion of Hill's & Dale's Partnership's 41.644 acre tract as is described in O. R. Vol. 72, Page 893.

This description prepared from an actual field survey performed by Timothy L. Notestine, P.S. #S-7815 on August 8, 1997.



TIMOTHY L. NOTESTINE, P.E., P.S.
135 NORTH DETROIT STREET
BELLEFONTAINE OH 43311

DATE OF SURVEY, AUGUST 8, 1997

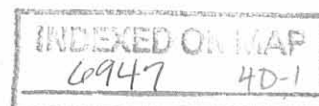

CITY OF BELLEFONTAINE SURVEY
TRACT I

The following described real estate situated in the State of Ohio, County of Logan, Township of Lake, City of Bellefontaine, being a part of V.M.S. 4399 and more particularly described as follows:

Beginning at a 5/8 inch iron bar found at the northwest corner of the City of Bellefontaine, Ohio's 5.500 acre tract as is described in D. B. Vol. 338, Page 814, and also being in the north line of said V.M.S. 4399 and in the south line of the Village of Bellefontaine's 5.700 acre tract as described in D. B. Vol. 65, Page 634,

Thence with the south line of said 5.700 acre tract, S.86°-34'-51"E. 18.51 feet to a 5/8 inch iron bar found in the proposed west right-of-way line of Lakewood Drive,

Thence continuing with said proposed right-of-way line and the proposed north right-of-way line of Ashbrook Drive on a 25.00 foot radius curve to the right, having a central angle of 56°-40'-11", an arc length of 24.73 feet, a chord bearing and length of S.29°-24'-39"W. 23.73 feet to a concrete monument found,

Thence continuing with said proposed Ashbrook Drive right-of-way line S.57°-44'-44"W. 7.44 feet to a concrete monument found in the west line of said City's 5.500 acre tract and the east line of Hill's and Dale's Partnership's 41.644 acre tract as is described in O. R. Vol. 72, Page 893 (Tract II),

Thence with the east line of said 41.644 acre tract, N.1°-10'-31"W. (said east line bearing being assumed and all other distances and bearings are as measured by this survey) 25.75 feet to the place of beginning.

Containing 0.008 acres, more or less, and being a portion of the City of Bellefontaine, Ohio's 5.500 acre tract) as is described in D. B. Vol. 338, Page 814.

This description prepared from an actual field survey performed by Timothy L. Notestine, P.S. #S-7815 on August 8, 1997.

Timothy L. Notestine

TIMOTHY L. NOTESTINE, P.E., P.S.
135 NORTH DETROIT STREET
BELLEFONTAINE, OHIO 43311



DATE OF SURVEY, AUGUST 8, 1997

INDEXED ON MAP
6947 402

CITY OF BELLEFONTAINE SURVEY

TRACT II

The following described real estate situated in the State of Ohio, County of Logan, Township of Lake, City of Bellefontaine, being a part of V.M.S. 4399 and more particularly described as follows:

Beginning for reference at a 5/8 inch iron bar found at the northwest corner of the City of Bellefontaine, Ohio's 5.500 acre tract as is described in D. B. Vol. 338, Page 814 and also being in the north line of said V.M.S. 4399 and in the south line of the Village of Bellefontaine's 5.700 acre tract as is described in D. B. Vol. 65, Page 634,

Thence with the east line of the Hills & Dales Partnership's 41.644 acre tract as is described in O. R. Vol. 72, Pg. 893, (Tract II) S.01°-10'-31"E. 95.81 feet to a concrete monument found at the true point of beginning of this description (said east line bearing being assumed and all other distances and bearings are as measured by this survey) in the proposed south right-of-way line of Ashbrook Drive and passing a concrete monument found in the proposed north right-of-way line of Ashbrook Drive at 25.75 feet,

Thence continuing with said proposed south right-of-way line of Ashbrook Drive N.57°-44'-44" E. 1.02 feet to a concrete monument found,

Thence continuing with said proposed right-of-way line and the proposed west right-of-way line of Lakewood Drive on a 25.00 foot radius curve to the right, having a central angle of 117°-15'-41", an arc length of 51.16 feet, a chord bearing and length of S.63°-37'-25"E. 42.69 feet to a concrete monument found,

Thence continuing with said proposed west right-of-way line of Lakewood Drive on a 574.00 foot radius curve to the right, having a central angle of 3°-49'-03", an arc length of 38.24 feet, a chord bearing and length of S.3°-05'-03"E. 38.24 feet to a concrete monument found,

Thence continuing with said proposed right-of-way line 40.00 feet east of and parallel to the east line of the aforementioned 41.644 acre tract, S.1°-10'-31"E. 251.91 feet to a concrete monument found,

Thence continuing with said proposed right-of-way line and the proposed north right-of-way line of Scenic Hill Court on a 25.00 foot radius curve to the right, having a central angle of 90°-00'-00", an arc length of 39.27 feet, a chord bearing and length of S.43°-49'-29"W. 35.36 feet, to a concrete monument found,

Thence continuing with said proposed north right-of-way line of Scenic Hill Court S.88°-49'-29"W. 15.00 feet to a concrete monument found in the east line of said 41.644 acre tract,

Thence with the east line of said 41.644 acre tract, N.1°-10'-31"W. 334.35 feet to the place of beginning.

Containing 0.303 acres, more or less, all of which is part of the City of Bellefontaine, Ohio's 5.500 acre tract as described in D. B. Vol. 338, Page 814.

This description prepared from an actual field survey performed by Timothy L. Notestine, P.S., #S-7815 on August 8, 1997.

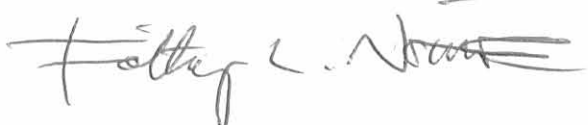
Timothy L. Notestine, P.E., P.S.
135 North Detroit Street
Bellefontaine, Ohio 43311

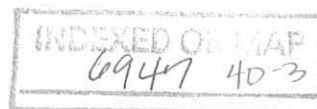

CITY OF BELLEFONTAINE SURVEY

TRACT III

The following described real estate situated in the State of Ohio, County of Logan, Township of Lake, City of Bellefontaine, being a part of V.M.S. 4399 and more particularly described as follows:

Beginning at a 5/8 inch iron bar found at the southwest corner of the City of Bellefontaine, Ohio's 5.500 acre tract as is described in D. B. Vol. 338, Page 814, and also being in an east line of the Hill's and Dale's Partnership's 41.644 acre tract as is described in O. R. Vol. 72, Page 893 (Tract II),

Thence, with the east line of said 41.644 acre tract, N.1°-10'-31"W. (this bearing is assumed and all other distances and bearings are as measured by this survey) 97.04 feet to a concrete monument found in the proposed south right-of-way line of Scenic Hill Court,

Thence, continuing with said proposed south right-of-way line of Scenic Hill Court, N.88°-49'-29"E. 15.00 feet to a concrete monument found,

Thence, continuing with said proposed south right-of-way line and the proposed west right-of-way line of Lakewood Drive on a 25.00 foot radius curve to the right, having a central angle of 90°-00'-00", an arc length of 39.27 feet, a chord bearing and length of S.46°-10'-31"E. 35.36 feet to a concrete monument found,

Thence, continuing with the proposed west right-of-way line of Lakewood Drive and 40.00 feet east of and parallel to the east line of the aforementioned 41.644 acre tract, S.1°-10'-31"E. 80.90 feet to a concrete monument found in a line of said 41.644 acre tract,

Thence, with the line of said 41.644 acre tract, N.78°40'-46"W. 40.97 feet to the place of beginning.

Containing 0.090 acres, more or less, and being a portion of the City of Bellefontaine, Ohio's 5.500 acre tract as is described in D. B. Vol. 338, Page 814.

This description prepared from an actual field survey performed by Timothy L. Notestine, P.S. #S-7815 on August 8, 1997.



TIMOTHY L. NOTESTINE, P.E., P.S.
135 NORTH DETROIT STREET
BELLEFONTAINE, OHIO 43311

DATE OF SURVEY, AUGUST 8, 1997

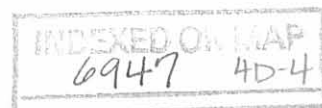

CITY OF BELLEFONTAINE SURVEY

SITUATED IN V.M.S. 4399 & 4478, CITY OF
BELLEFONTAINE, LAKE TWP., LOGAN COUNTY, OHIO

VILLAGE OF BELLEFONTAINE
5.700 Ac. D.B. VOL. 65,
PAGE 634 TRACT I
FRED CARTER PARK

CITY OF BELLEFONTAINE, OHIO
5.500 Ac. DB. VOL. 338
PG. 814
FRED CARTER PARK

PROPOSED
FRED CARTER PARK ESTATES

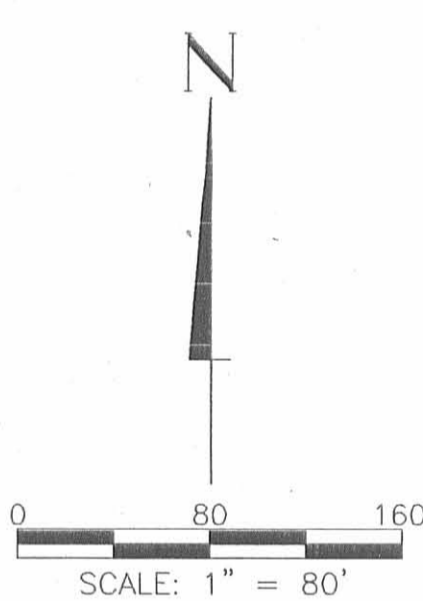

NUMBER	RADIUS	DELTA ANGLE	ARC	CHORD BEARING	CHORD
C1	25.00'	56°40'11"	24.73'	S. 29°24'39" W.	23.73'
C2	25.00'	117°15'41"	51.16'	S. 63°37'25" E.	42.69'
C3	574.00'	03°49'03"	38.24'	S. 03°05'03" E.	38.24'
C4	25.00'	90°00'00"	39.27'	S. 43°49'29" W.	35.36'
C5	25.00'	90°00'00"	39.27'	S. 46°10'31" E.	35.36'
C6	570.00'	01°33'34"	15.51'	S. 01°57'18" E.	15.51'
C7	630.00'	01°33'34"	17.15'	N. 01°57'18" W.	17.15'

✕ = 5/8" IRON BAR FOUND
• = CONCRETE MONUMENTS FOUND

Timothy L. Notestine
TIMOTHY L. NOTESTINE P.E., P.S.
135 N. DETROIT ST.
BELLEFONTAINE, OHIO 43311
SURVEY DATE: 8-8-97

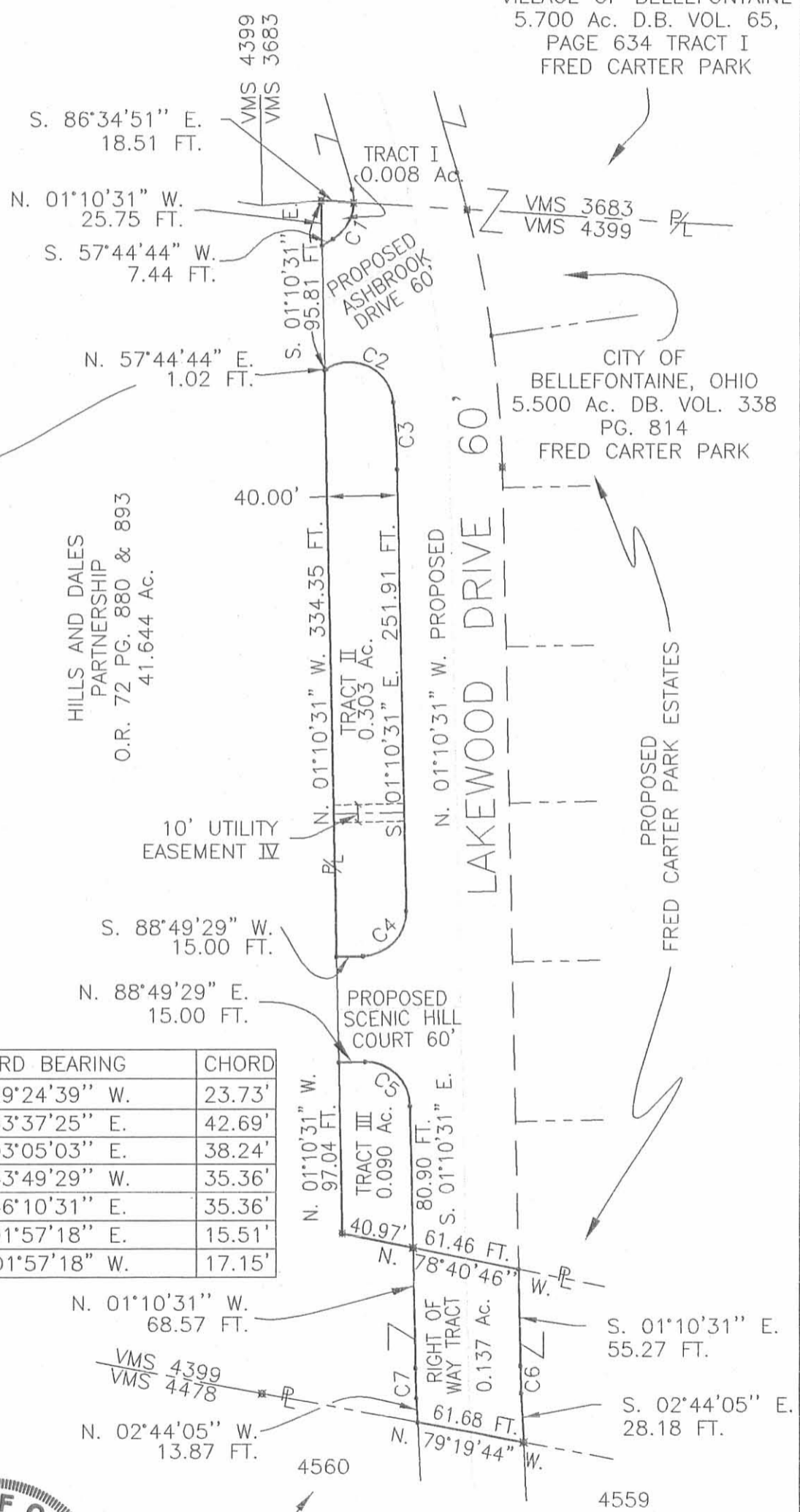

INDEXED ON MAP
6947 4P

CONSULTING
CIVIL & SANITARY
ENGINEERS



1280 NORTH COLE STREET • LIMA, OHIO 45801 • TELEPHONE 419-228-4421

June 5, 1985

DESCRIPTION
12.02 Acre Tract
JOB #8974

Being a parcel of land situated in the City of Bellefontaine, Lake Township, Logan County, Ohio and in Virginia Military Survey 4399 and being more particularly described as follows:

Starting at the intersection of the centerlines of Shady Lane Drive with Sandusky Avenue; thence north $75^{\circ}-21'-33''$ east, along the centerline of Sandusky Avenue, 253.25 feet to a P.K. nail set at the northeast corner of a parcel of land recorded at Deed Volume 340 - Page 820 of the Logan County, Ohio Recorder's Office; thence south $14^{\circ}-38'-27''$ east, for a distance of 30.00 feet to an iron pin found; thence south $8^{\circ}-11'-24''$ west, for a distance of 10.85 feet to the principal point of beginning for the parcel to be conveyed by this instrument -

(1) Thence from this place of beginning north $75^{\circ}-21'-33''$ east, along a line 40 feet normal to the centerline of Sandusky Avenue, for a distance of 388.46 feet to an iron pin set -

(2) Thence south $14^{\circ}-38'-27''$ east, for a distance of 140.00 feet to a railroad spike found -

(3) Thence north $75^{\circ}-21'-33''$ east, for a distance of 150.00 feet to a P.K. nail set -

(4) Thence north $14^{\circ}-38'-27''$ west, for a distance of 140.00 feet to an iron pin set -

(5) Thence north $75^{\circ}-21'-33''$ east, for a distance of 125.74 feet to a P.K. nail set -

(6) Thence south $14^{\circ}-37'-27''$ east, for a distance of 460.00 feet to a P.K. nail set -

(7) Thence south $41^{\circ}-07'-20''$ west, for a distance of 60.01 feet to a P.K. nail found -

(8) Thence south $14^{\circ}-37'-27''$ east, for a distance of 235.00 feet to a P.K. nail set -

INDEXED ON MAP
69475D-1

Page #2 - 12.02 Acre Tract

(9) Thence south $18^{\circ}-39'-31''$ west, for a distance of 85.44 feet to an iron pin set -

(10) Thence south $75^{\circ}-22'-33''$ west, for a distance of 328.06 feet to an iron pin set -

(11) Thence north $51^{\circ}-20'-21''$ west, for a distance of 304.46 feet to a railroad spike found -

(12) Thence south $75^{\circ}-27'-33''$ west, for a distance of 217.50 feet to an iron pin found -

(13) Thence north $9^{\circ}-32'-27''$ west, for a distance of 160.00 feet to an iron pin set -

(14) Thence north $7^{\circ}-40'-57''$ west, for a distance of 127.10 feet to an iron pin set -

(15) Thence north $35^{\circ}-53'-37''$ west, for a distance of 150.00 feet to an iron pin set -

(16) Thence north $75^{\circ}-29'-03''$ east, for a distance of 130.00 feet to an iron pin found -

(17) Thence north $8^{\circ}-11'-24''$ east, for a distance of 141.25 feet to the point of beginning.

Containing in all 12.02 acres of land, subject, however to all legal easements and rights-of-way of record.

REC/sd

Robert E. Chambers
Robert E. Chambers
Reg. Surveyor #6081

Seal

Also Statement



CONSULTING
CIVIL & SANITARY
ENGINEERS



1280 NORTH COLE STREET • LIMA, OHIO 45801 • TELEPHONE 419-228-4421

May 29, 1985

DESCRIPTION
2.18 Acre Tract
JOB #8974

Being a parcel of land situated in the City of Bellefontaine, Lake Township, Logan County, Ohio and in Virginia Military Survey 4399 and being more particularly described as follows:

Commencing for reference at the intersection of the centerlines of Shady Lane Drive and Sandusky Avenue; thence north $75^{\circ}-21'-33''$ east on and along the centerline of Sandusky Avenue for a distance of 979.92 feet; thence south $7^{\circ}-25'-04''$ east for a distance of 40.32 feet to the point of beginning -

(1) Thence continuing south $7^{\circ}-25'-04''$ east, for a distance of 270.90 feet to an iron pin found -

(2) Thence north $85^{\circ}-42'-19''$ east, for a distance of 140.05 feet to an iron pin set 30.00 feet normal to the centerline of Lakewood Drive -

(3) Thence south $6^{\circ}-08'-06''$ east on and along a line 30.00 feet normal to the centerline of Lakewood Drive, for a distance of 499.47 feet to an iron pin set -

(4) Thence south $83^{\circ}-51'-54''$ west, for a distance of 36.00 feet to an iron pin set -

(5) Thence south $68^{\circ}-46'-18''$ west, for a distance of 153.58 feet to an iron pin set -

(6) Thence north $18^{\circ}-39'-31''$ east, for a distance of 85.44 feet to a P.K. nail set -

(7) Thence north $14^{\circ}-37'-27''$ west, for a distance of 235.00 feet to a P.K. nail found -

(8) Thence north $41^{\circ}-07'-20''$ east, for a distance of 60.01 feet to a P.K. nail set -

(9) Thence north $14^{\circ}-37'-27''$ west, for a distance of 460.00 feet to a P.K. nail set 40.00 feet normal to the centerline of Sandusky Avenue -

INDEXED ON MAP
6947 5D-3

Page #2 - 2.18 Acre Tract

(10) Thence north $75^{\circ}-21'-33''$ east on and along a line 40.00 feet normal to the centerline of Sandusky Avenue, for a distance of 61.61 feet to the point of beginning.

Containing in all 2.18 acres of land, subject, however to all legal easements and rights-of-way of record.

Robert E. Chambers

Robert E. Chambers
Reg. Surveyor #6081

REC/sd

seal

Also Statement

INDEXED ON MAP
6947 5D-4

PLAT OF A SURVEY IN THE CITY OF BELLEFONTAINE & IN VIRGINIA MILITARY SURVEY 4399 LAKE TOWNSHIP LOGAN COUNTY, OHIO

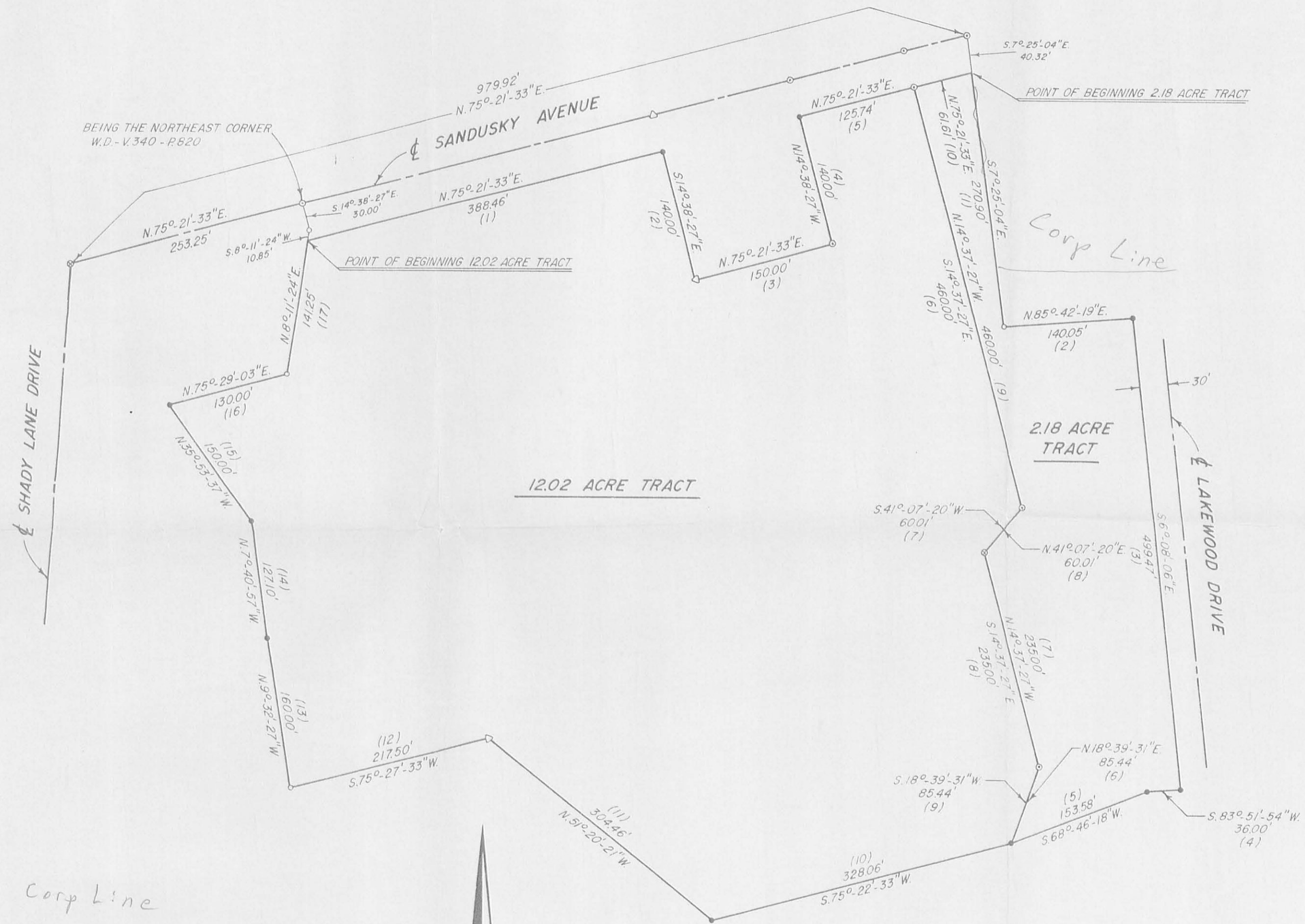

- LEGEND**
- - IRON PIN SET
 - - IRON PIN FOUND
 - ⊙ - P. K. NAIL SET
 - ⊗ - P. K. NAIL FOUND
 - ⊠ - RAILROAD SPIKE FOUND

ROBERT E. CHAMBERS
REG. SURVEYOR # 6081

Corp Line
E. Page 5
I Page 5
Surrounding Property Owners
Reproducible Stamp (seal)

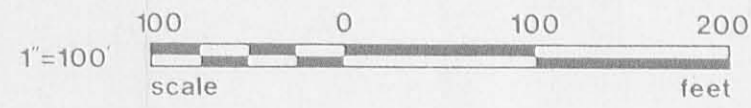
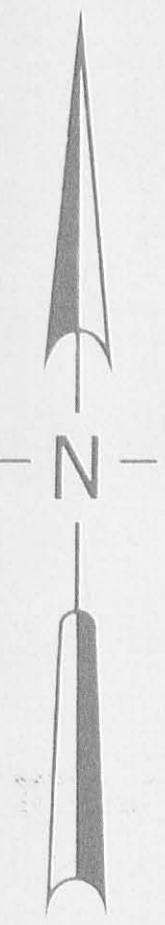

INDEXED ON MAP
694-7 5P

SHELDON & ASSOC. INC.

LIMA, OHIO

MAY 30, 1985	DATE	JOB NO. 8974
DRAWN	D.J.K.	
CHECKED		
APPROVED		SCALE SHOWN

BOUNDARY SURVEY
PROPOSED
"HILLS AND DALES"

The following described real estate situated in the State of Ohio, County of Logan, Township of Lake, City of Bellefontaine, being part of the Virginia Military Surveys 4399 and 4478 and more particularly described as follows:

Beginning at an existing wood corner post at the northwest corner of the Reservoir Road Allotment, Plat Book 6, Volume F, Page 72, said post also in the east line of V.M.S. 4990.

THENCE with the east line of V.M.S. 4990, N.6°09'58"E. 818.80 feet to a concrete monument found marking the southwest corner of Ashbrook Addition No. 1, Plat Cabinet A, Slide 605.

THENCE with the south line of said Ashbrook Addition No. 1 and the south line of Ashbrook Addition No. 2, O.R. Volume 21, Page 377, the following 5 courses:

S.83°45'02"E. 180.04 feet to a concrete monument found.

N.6°20'12"E. 9.99 feet to a 5/8 inch iron found.

S.83°43'04"E. 259.78 feet to a 5/8 inch iron found.

S.74°52'54"E. 199.86 feet to a 5/8 inch iron found.

And S.85°27'55"E. 90.16 feet to a 5/8 inch iron found in the west line of Lot 4338 of Hyland Hills Estates, Phase V, Addition, Plat Book 6, Volume F. Page 76.

THENCE with the west line of said Lot 4338, S.5°28'11"W. 400.36 feet to a 5/8 inch iron set.



THENCE with the south line of said Lot 4338, N.85°50'53"E. 242.27 feet to a 5/8 inch iron found.

THENCE with east line of said Lot 4338, N.32°02'36"E. 64.57 feet to a 5/8 inch iron found.

THENCE continuing with the east line of said Lot 4338, N.5°20'11"E. 233.35 feet to a 5/8 inch iron found.

THENCE continuing with the east line of said Lot 4338, N.85°40'39"W. 49.30 feet to a steel corner post found.

THENCE continuing with the east line of said Lot 4338, N.4°49'11"E. 193.31 feet to a 1 inch pipe found marking the northeast corner of said Lot 4338, said pipe also in the south line of Shady Lane Drive, Shady Lane Partnership, D.B. Vol. 390, Page 662.

THENCE with the south line of said Shady Lane Drive and the south line of Red Bud Hill, LTD's 3.749 acre tract, O.R. Vol. 12, Page 167, S.87°41'05"E. 344.11 feet to a 1 inch pipe found marking the south west corner of Bellefontaine Gardens, 4.1758 acre tract, D.B. Vol. 370, Page 710, passing a 5/8 inch iron found marking the southwest corner of said Red Bud Hill, LTD's 3.749 acre tract at 80.74 feet.

THENCE with the south line of said Bellefontaine Gardens, S.85°51'50"E. 415.43 feet to a 5/8 inch iron found marking the southwest corner of Bellefontaine Manor, LTD's 4.59 acre tract, D.B. Vol. 368, Page 213.

THENCE with the south line of said Bellefontaine Manor, LTD's, S.85°59'50"E. 469.25 feet to a wood corner post found marking the southwest corner of the City of Bellefontaine's 5.7 acre tract, D.B. Vol. 65, Page 634.

THENCE with the south line of said City of Bellefontaine's 5.7 acre tract, N.88°11'03"E. 40.11 feet to the northwest corner of the City of Bellefontaine's 5.5 acre tract, D.B. Vol. 338, Page 514.

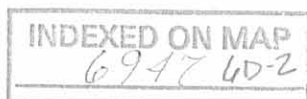

THENCE with the west line of said City of Bellefontaine's 5.5 acre tract, S.5^o12'02"E. 581.56 feet to a 5/8 inch iron found marking the southwest corner of said 5.5 acre tract.

THENCE with the south line of said 5.5 acre tract, S.83^o18'46"E. 328.81 feet to a 5/8 inch iron found marking the southeast corner of said 5.5 acre tract, said iron also in the west line of Richard E. and Cynthia Westerman's 31.654 acre tract, O.R. Vol. 43, Page 125.

THENCE with said Westerman's west line, S. 8^o23'13"W. 91.66 feet.

THENCE N.83^o49'52"W. 941.37 feet to a concrete monument found marking the northwest corner of Westerman Allotment No. 2, Plat Cabinet A, Slide 607.

THENCE with the west line of said Westerman Allotment No. 2, S.6^o08'27"W. 479.95 feet to a concrete monument found marking the southwest corner of said Westerman Allotment No. 2, said monument also marking the northeast corner of Lot 4353 of Westerman Allotment No. 1.

THENCE with the north line of said Lot 4353, N.84^o07'32"W. 69.10 feet to a 5/8 inch iron found marking the northeast corner of Hyland Hills Estates, Phase IV, Plat Book 6, Volume F. Page 69.

THENCE with the north line of said Hyland Hills Estates, Phase IV, N.83^o59'57"W. 508.66 feet to a 5/8 inch iron found marking the northwest corner of said Hyland Hills Estates, Phase IV, said iron also in the east line of the City of Bellefontaine's 4.7 acre tract, Reservoir Site.

THENCE with the east of said 4.7 acre tract, N.6^o23'35"E. 374.17 feet to a steel corner post found marking the northeast corner of said 4.7 acre tract.

THENCE with the north line of said 4.7 acre tract, N.83^o50'31"W. 355.05 feet to a steel corner post found marking the northwest corner of said 4.7 acre tract.



THENCE with the west line of said 4.7 acre tract, S. $6^{\circ}33'27''$ W. 221.63 feet to a 5/8 inch iron found marking the northeast corner of said Reservoir Road Allotment.

THENCE with the north line of said Reservoir Road Allotment, N. $83^{\circ}17'58''$ W. 774.65 feet to the place of beginning.

Containing 41.644 acres, more or less, of which 28.599 acres are in V.M.S. 4399 and 13.045 acres are in V.M.S. 4478.

The above described 41.644 acre tract being the same 42.03 acre tract in the name of Dwight E. Reed and Dwight H. Reed as described in D.B. Vol. 386, Page 982.

Basis for bearings: North line of Hyland Hills Estates, Phase IV, (N. $83^{\circ}59'57''$ W. Assumed)

This description prepared from an actual field survey.

Prepared by:

Richard A. Bruce

Richard A. Bruce
Reg. Surveyor No. 6993
October 3, 1988



BOUNDARY SURVEY "HILLS AND DALE'S"

V.M.S. 4399 & 4478
CITY OF BELLEFONTAINE
LOGAN COUNTY, OHIO

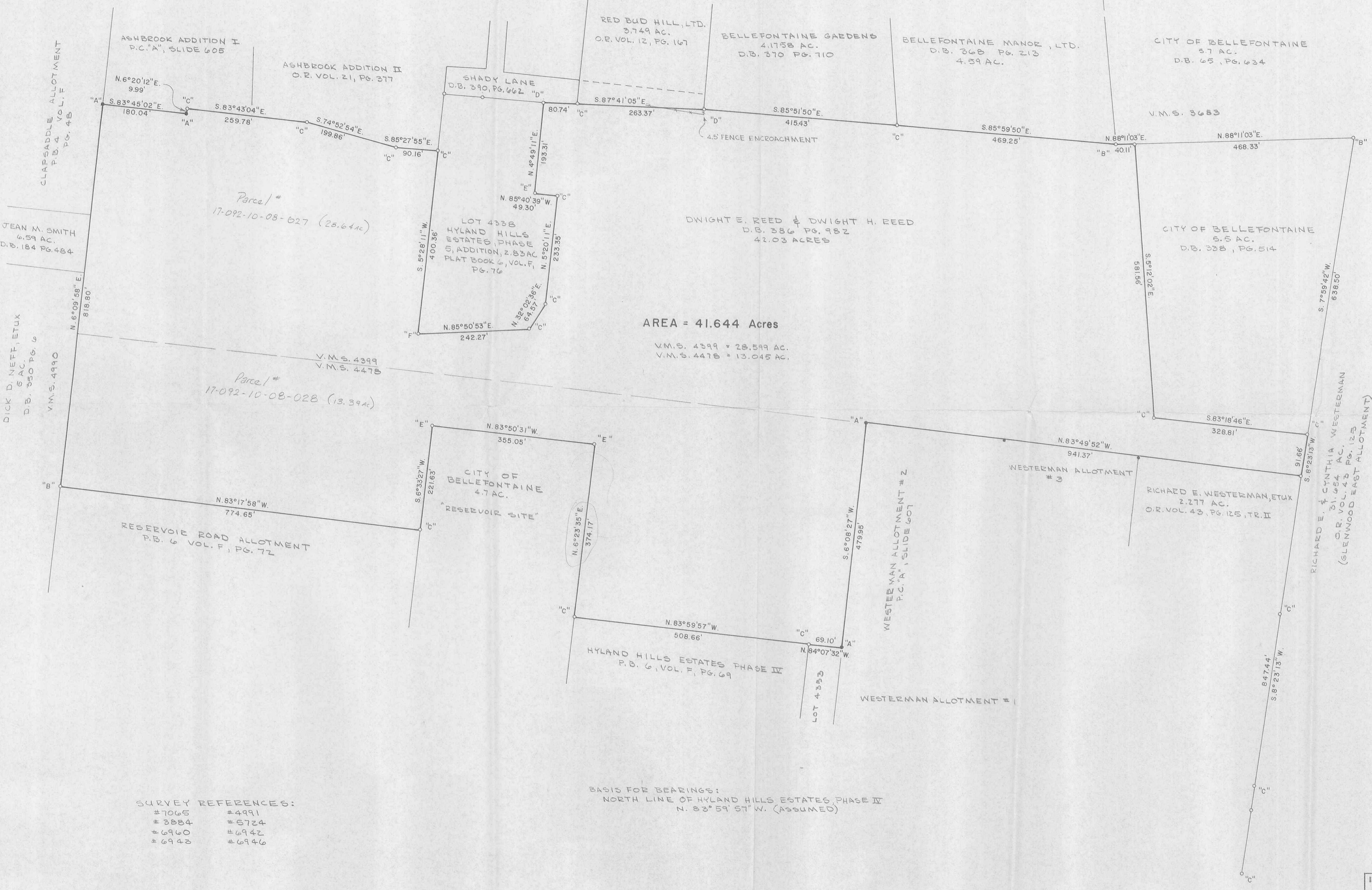

AREA = 41.644 Acres
V.M.S. 4399 = 28.599 AC.
V.M.S. 4478 = 13.045 AC.

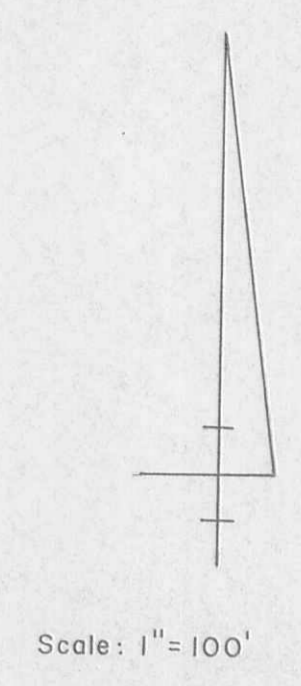

- LEGEND**
- A - Existing Concrete Monument
 - B - Existing Wood Corner Post
 - C - Existing Iron Pin
 - D - Existing Pipe
 - E - Existing Steel Corner Post
 - F - 5/8" Iron Bar Set

- SURVEY REFERENCES:**
- #7065 #4991
 - #3884 #5724
 - #6960 #6942
 - #6943 #6946

BASIS FOR BEARINGS:
NORTH LINE OF HYLAND HILLS ESTATES, PHASE IV
N. 83° 59' 57" W. (ASSUMED)

INDEXED ON MAP
6947 GP



SURVEYED BY: Richard A. Bruce
REG. SURVEYOR # 6993
AUGUST, 1988

Lee Surveying and Mapping Co.



Farm Surveys • Lot Surveys • Topography • Subdivisions • Construction Layout

855 EAST SANDUSKY AVENUE
BELLEFONTAINE, OHIO 43311

(513) 593-5780

CLAYTON M. LEE, P.S.
JEFFREY I. LEE, P.S.

RETENTION AND STORM LINE EASEMENT

POWELL TO WESTERMAN

Lying in the City of Bellefontaine, V.M.S. 4478, & V.M.S. 4399, Lake Twp., Logan County, Ohio and being part of that land lying in the name of Robert E. Powell deeded and described in Volume 328, Page 39-42 of the Logan County Records of Deeds and lying adjacent to a 13.48 acre tract in the name of Westerman (Volume 370, Page 804) and more particularly described as follows:

Beginning at the northwest corner of the said 13.58 acres.

THENCE, with the north line of said 13.58 acres, S 83°-40' E, a distance of 13.95 feet.

THENCE, N 37°-52'-21" W, a distance of 153.96 feet to the south line of the retention pond area, this line forming the east line of a 20 foot wide storm sewer easement.

THENCE, with the retention pond area, N 82°-07' E, a distance of 40.45 feet to an iron rod.

THENCE, N 7°-53' W, a distance of 70.00 feet to an iron rod.

THENCE, S 82°-07' W, a distance of 205.00 feet to an iron rod.

THENCE, S 7°-53' E, a distance of 70.00 feet to an iron rod.

THENCE, N 82°-07' E, a distance of 141.45 feet to the northwest corner of the 20 foot storm line easement.

THENCE, with the west line of said 20 foot easement, S 37°-52'-21" E, a distance of 165.50 feet to the west line of the aforementioned 13.58 acres.

THENCE, with said west line, N 5°-59'-03" E, a distance of 13.95 feet to the point of beginning. Containing 0.401 acre. Of which 0.399 acre lies in V.M.S. 4399 and 0.002 acre lies in V.M.S. 4478.

Last previous deed reference: Volume 328, Page 39-42.

Surveyed by:

Clayton M. Lee

Clayton M. Lee

Reg. Surveyor No. 6181

7-6-79

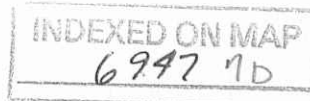

Lee Surveying and Mapping Co.



Farm Surveys • Lot Surveys • Topography • Subdivisions • Construction Layout

855 EAST SANDUSKY AVENUE
BELLEFONTAINE, OHIO 43311

(513) 593-5780

CLAYTON M. LEE, P.S.
JEFFREY I. LEE, P.S.

RETENTION AND STORM LINE EASEMENT

POWELL TO WESTERMAN

Lying in the City of Bellefontaine, V.M.S. 4478 & V.M.S. 4399, Lake Twp., Logan County, Ohio and being part of that land lying in the name of Robert E. Powell deeded and described in Volume 328, Page 39-42 of the Logan County Records of Deeds and lying adjacent to a 13.48 acre tract in the name of Westerman (Volume 370, Page 804) and more particularly described as follows:

Beginning at the northwest corner of the said 13.58 acres.

THENCE, with the north line of said 13.58 acres, S 83°-40' E, a distance of 13.95 feet.

THENCE, N 37°-52'-21" W, a distance of 153.96 feet to the south line of the retention pond area, this line forming the east line of a 20 foot wide storm sewer easement.

THENCE, with the retention pond area, N 82°-07' E, a distance of 40.45 feet to an iron rod.

THENCE, N 7°-53' W, a distance of 70.00 feet to an iron rod.

THENCE, S 82°-07' W, a distance of 205.00 feet to an iron rod.

THENCE, S 7°-53' E, a distance of 70.00 feet to an iron rod.

THENCE, N 82°-07' E, a distance of 141.45 feet to the northwest corner of the 20 foot storm line easement.

THENCE, with the west line of said 20 foot easement, S 37°-52'-21" E, a distance of 165.50 feet to the west line of the aforementioned 13.58 acres.

THENCE, with said west line, N 5°-59'-03" E, a distance of 13.95 feet to the point of beginning. Containing 0.401 acre. Of which 0.399 acre lies in V.M.S. 4399 and 0.002 acre lies in V.M.S. 4478.

Last previous deed reference: Volume 328, Page 39-42.

Surveyed by:

Clayton M. Lee

Clayton M. Lee
Reg. Surveyor No. 6181
7-6-79

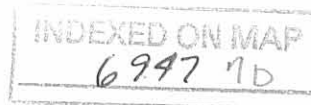

REV 5-20-11 8/11/11

Lee Surveying and Mapping Co., Inc.

Land Surveys • Topography • Subdivisions • Construction Layout

117 N. Madriver St.
Bellefontaine OH 43311



Phone: (937) 593-7335
Fax: (937) 593-7444
surveys@lsminc.us

ZEUS SHOPPING CENTER, INC. UTILITY EASEMENT #1

Lying in Virginia Military Survey 4399, City of Bellefontaine, Lake Township, Logan County, Ohio.

Being a 10.00 feet wide utility easement over a portion of the Zeus Shopping Center, Inc., 11.865 acre tract as deeded and described in Official Record 203, Page 855, Tract 1, the 0.3372 acre tract as deeded and described in Official Record 424, Page 250, the 0.223 acre tract as deeded and described in Official record 270, Page 644 and the 2.18 acre tract as deeded and described in Official Record 203, Page 855, Tract 2 of the Logan County Records of Deeds and being more particularly described as follows:

Commencing on a PK nail found on the intersection of Sandusky Avenue (Ohio Route 540) and Newford Drive.

THENCE, with the center-line of Sandusky Avenue (variable widths), S 76°-59'-29"W, a distance of 527.40 feet to a railroad spike found.

THENCE, with the west line of the Quest Federal Credit Union 0.620 acre tract (O.R. 994, Pg. 677), S 13°-08'-59"E, a distance of 45.00 feet to a MAG nail set at the TRUE POINT OF BEGINNING, passing a 5/8 inch iron rod found at 30.00 feet.

THENCE, with the center-line of said easement, the following eleven courses:

S 76°-50'-01"W, a distance of 395.82 feet to a MAG nail set.

N 09°-40'-01"E, a distance of 10.61 feet to a MAG nail set.

S 75°-21'-33"W, a distance of 80.70 feet to a 5/8 inch iron rod set.

S 06°-06'-58"W, a distance of 140.91 feet to a 5/8 inch iron rod set.

S 25°-11'-25"E, a distance of 145.97 feet to a 5/8 inch iron set.

S 05°-01'-17"W, a distance of 130.32 feet to a MAG nail set.

S 08°-03'-43"E, a distance of 153.87 feet to a 5/8 inch iron rod set.

N 76°-57'-07"E, a distance of 177.13 feet to a MAG nail set.

S 49°-46'-04"E, a distance of 304.76 feet to a MAG nail set.



Lee Surveying and Mapping Co., Inc.

Land Surveys • Topography • Subdivisions • Construction Layout

117 N. Madriver St.
Bellefontaine OH 43311

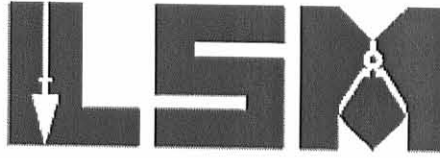

Phone: (937) 593-7335
Fax: (937) 593-7444
surveys@lsminc.us

N 76°-49'-30"E, a distance of 362.64 feet to a MAG nail set.

N 70°-16'-52"E, a distance of 150.37 feet to a 5/8 inch iron rod set at the terminus of this easement.

The sidelines of said easement to be shortened or prolonged to meet at angle point intersections.

Property is subject to any and all previous easements and rights-of-way of record.

The basis for bearings is the center-line of Sandusky Avenue, being S 76°-59'-29"W, and all other bearings are from angles and distances measured in a field survey by Lee Surveying and Mapping Co., Inc. on May 9, 2011.



ORIGINAL STAMP IN GREEN

Description prepared by:

A handwritten signature in cursive script that reads 'William K. Bruce'.

William K. Bruce
Professional Surveyor 7437
May 16, 2011

51310411



REC'D 5-20-11 smy oc

Lee Surveying and Mapping Co., Inc.

Land Surveys • Topography • Subdivisions • Construction Layout

117 N. Madriver St.
Bellefontaine OH 43311



Phone: (937) 593-7335
Fax: (937) 593-7444
surveys@lsminc.us

ZEUS SHOPPING CENTER, INC. UTILITY EASEMENT #2

Lying in Virginia Military Survey 4399, City of Bellefontaine, Lake Township, Logan County, Ohio.

Being a utility easement over a portion of the Zeus Shopping Center, Inc., 2.18 acre tract as deeded and described in Official Record 203, Page 855, Tract 2 of the Logan County Records of Deeds and being more particularly described as follows:

Commencing on a PK nail found on the intersection of Sandusky Avenue (Ohio Route 540) and Newford Drive.

THENCE, with the center-line of Sandusky Avenue (variable widths), S 76°-59'-29"W, a distance of 527.40 feet to a railroad spike found.

THENCE, with the west line of the Quest Federal Credit Union 0.620 acre tract (O.R. 994, Pg. 677) and the east line extended and the east line of the Zeus Shopping Center, Inc., 11.865 acre tract (O.R. 203, Pg. 855, Tract 1), S 13°-08'-59"E, a distance of 45.00 feet to a MAG nail set, passing a 5/8 inch iron rod found at 30.00 feet.

THENCE, through the said 11.865 acre tract, the Zeus Shopping Center Inc., 0.3372 acre tract (O.R. 424, Pg. 250) and 0.223 acre tract (O.R. 270, Pg. 644) and the aforesaid 2.18 acre tract, the following eleven courses:

S 76°-50'-01"W, a distance of 395.82 feet to a MAG nail set.

N 09°-40'-01"E, a distance of 10.61 feet to a MAG nail set.

S 75°-21'-33"W, a distance of 80.70 feet to a 5/8 inch iron rod set.

S 06°-06'-58"W, a distance of 140.91 feet to a 5/8 inch iron rod set.

S 25°-11'-25"E, a distance of 145.97 feet to a 5/8 inch iron rod set.

S 05°-01'-17"W, a distance of 130.32 feet to a MAG nail set.

S 08°-03'-43"E, a distance of 153.87 feet to a 5/8 inch iron rod set.

N 76°-57'-07"E, a distance of 177.13 feet to a MAG nail set.

S 49°-46'-04"E, a distance of 304.76 feet to a MAG nail set.

N 76°-49'-30"E, a distance of 362.64 feet to a MAG nail set.

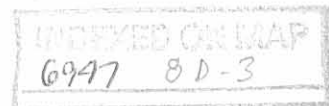

Lee Surveying and Mapping Co., Inc.

Land Surveys • Topography • Subdivisions • Construction Layout

117 N. Madriver St.
Bellefontaine OH 43311



Phone: (937) 593-7335
Fax: (937) 593-7444
surveys@lsminc.us

N 70°-16'-52"E, a distance of 150.37 feet to a 5/8 inch iron rod set at the TRUE POINT OF BEGINNING.

THENCE, N 04°-40'-23"W, a distance of 35.91 feet to a 5/8 inch iron rod set.

THENCE, N 85°-19'-37"E, a distance of 40.00 feet to a 5/8 inch iron rod set on the west right-of-way of Lakewood Drive.

THENCE, with the west right-of-way of Lakewood Drive (variable widths), S 04°-40'-23"E, a distance of 40.01 feet to a 5/8 inch iron rod found on the north right-of-way of Bonnie Lane.

THENCE, with the north right-of-way of Bonnie Lane (variable widths), the following two courses:

S 85°-18'-51"W, a distance of 36.00 feet to a 1/2 inch iron rod found.

S 70°-16'-52"W, a distance of 4.14 feet to a 5/8 inch iron rod set.

THENCE, N 04°-40'-23"W, a distance of 5.18 feet to the point of beginning.

Property is subject to any and all previous easements and rights-of-way of record.

The basis for bearings is the center-line of Sandusky Avenue, being S 76°-59'-29"W, and all other bearings are from angles and distances measured in a field survey by Lee Surveying and Mapping Co., Inc. on May 9, 2011.

Description prepared by:

A handwritten signature in black ink that reads "William K. Bruce".

William K. Bruce
Professional Surveyor 7437
May 16, 2011



ORIGINAL STAMP IN GREEN

51310411

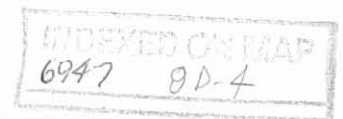

REV'D 5-20-11 SUM OK

LINE	BEARING	DISTANCE
L1	S 76°50'01" W	395.82'
L2	N 09°40'01" E	10.61'
L3	S 75°21'33" W	80.70'
L4	S 06°06'58" W	140.91'
L5	S 25°11'25" E	145.97'
L6	S 05°01'17" W	130.32'
L7	S 08°03'43" E	153.87'
L8	N 76°57'07" E	177.13'
L9	S 49°46'04" E	304.76'
L10	N 76°49'30" E	362.64'
L11	N 70°16'52" E	150.37'
L12	N 04°40'23" W	5.18'
L13	N 04°40'23" W	35.91'
L14	N 85°19'37" E	40.00'
L15	S 04°40'23" E	40.01'
L16	S 85°18'51" W	36.00'
L17	S 70°16'52" W	4.14'

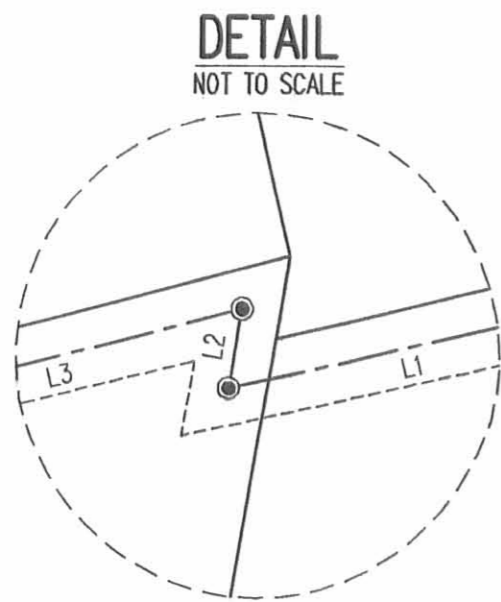

SCALE
100
FEET TO AN INCH

LEGEND:

- ⊗ PK NAIL FOUND
- ⊗ RAILROAD SPIKE FOUND
- ⊙ 1/2 INCH IRON ROD FOUND
- ⊙ MAG NAIL SET
- 5/8 INCH IRON ROD FOUND
- 5/8 INCH IRON ROD SET WITH PLASTIC I.D. CAP STAMPED "LSM 7437"

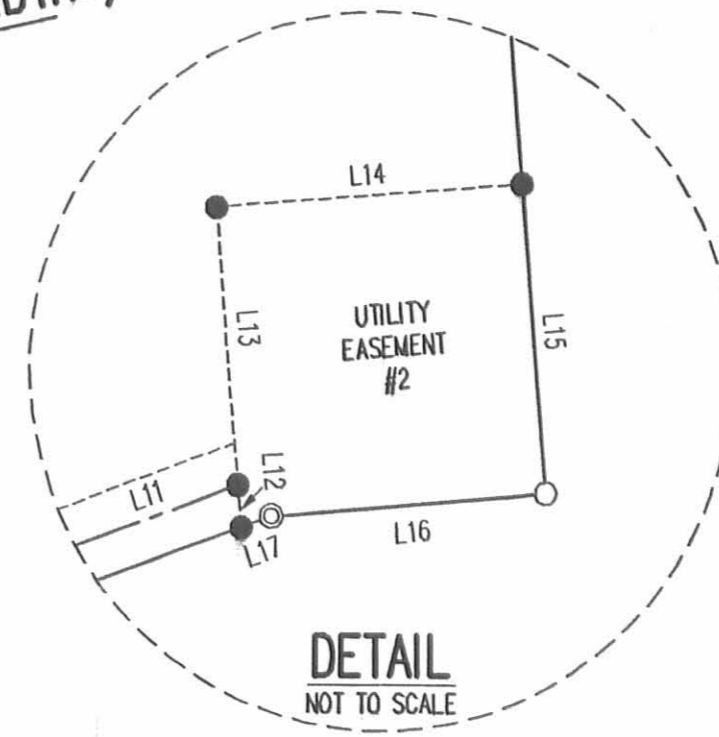
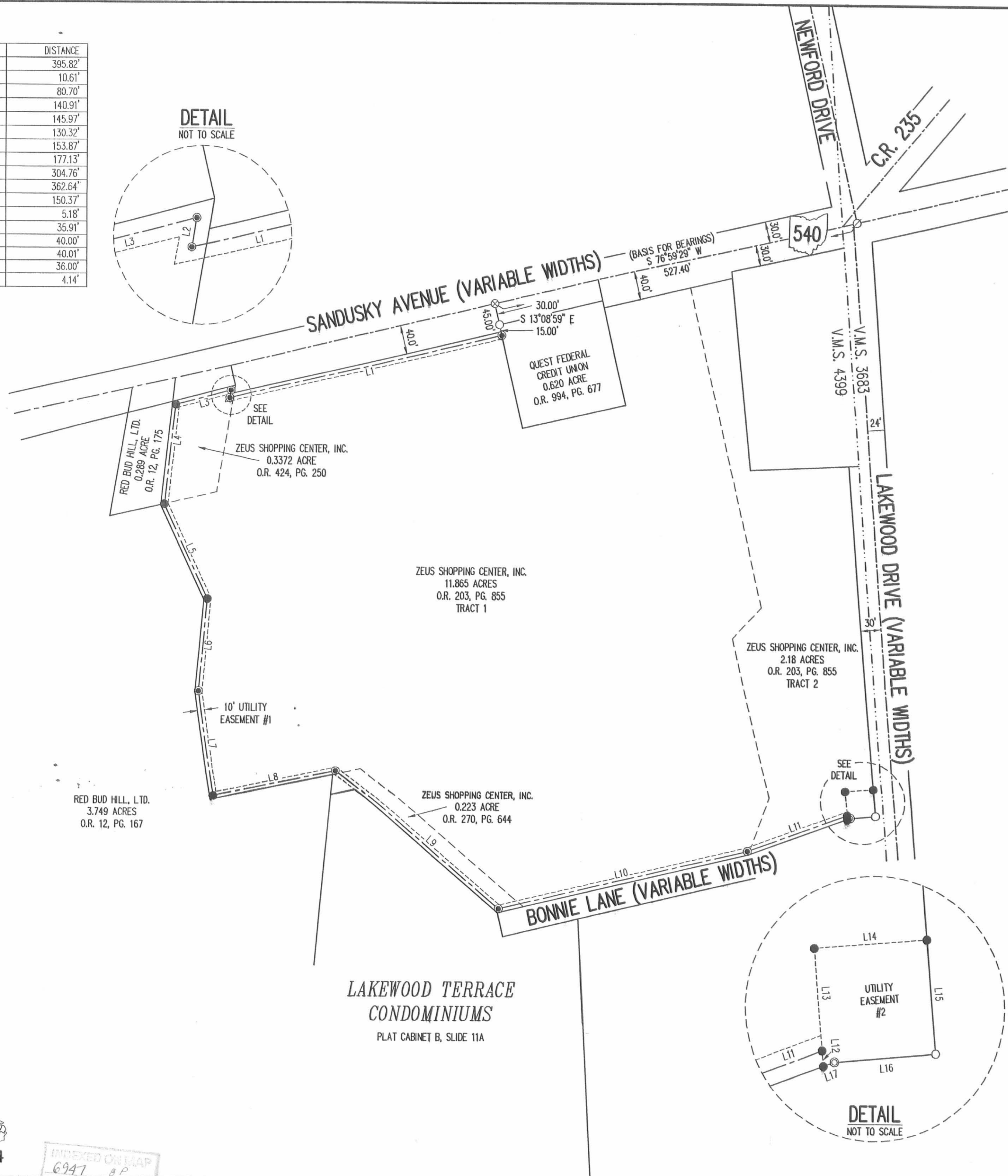

SURVEY OF UTILITY EASEMENTS OVER THE ZEUS SHOPPING CENTER, INC. 11.865 ACRE TRACT AND 2.18 ACRE TRACT OFFICIAL RECORD 203, PAGE 855 TRACT 1 AND TRACT 2, 0.3372 ACRE TRACT OFFICIAL RECORD 424, PAGE 250 AND 0.223 ACRE TRACT OFFICIAL RECORD 270, PG. 644 VIRGINIA MILITARY SURVEY 4399 CITY OF BELLEFONTAINE LAKE TOWNSHIP LOGAN COUNTY, OHIO



SURVEYED BY:
William K. Bruce
WILLIAM K. BRUCE
PROFESSIONAL SURVEYOR 7437
MAY 9, 2011

COPYRIGHT 2011 BY:
LEE SURVEYING & MAPPING CO., INC.
117 North Madriver Street
BELLEFONTAINE, OHIO 43311
(937) 593-7335
surveys@lsmcinc.us

KSS D0411 51310411 L-5131-2

2 WORKING DAYS
BEFORE YOU DIG
CALL TOLL FREE 800-362-2764
OHIO UTILITIES PROTECTION SERVICE

INDEXED ON MAP
6947 8P

Lee Surveying and Mapping Co., Inc.

Land Surveys • Topography • Subdivisions • Construction Layout

117 N. Madriver St.
Bellefontaine OH 43311



Phone: (937) 593-7335
Fax: (937) 593-7444
surveys@lsminc.us



LA ROSS, LLC 0.466 ACRE

Lying in Virginia Military Survey 4399, City of Bellefontaine, Lake Township, Logan County, Ohio.

Being out of the LA ROSS, LLC original 33.612 acre tract as deeded and described in Official Record 959, Page 669, Parcel I of the Logan County Records of Deeds and being more particularly described as follows:

Beginning on a 5/8 inch iron rod found on the south line of Virginia Military Survey 4399, the northwest corner of Lot 4559 of Glenwood East Allotment II (Plat Cabinet A, Slide 695B) and on the east right-of-way of Lakewood Drive.

THENCE, with the east right-of-way of Lakewood Drive (60 feet wide), the following three courses:

N 10°-15'-24"W, a distance of 27.24 feet to a 5/8 inch iron rod set.

With a curve to the right, having a central angle of 01°-33'-30", a radius of 570.00 feet, an arc length of 15.50 feet, a chord bearing N 09°-58'-38"W, a distance of 15.50 feet to a 5/8 inch iron rod found.

N 08°-47'-30"W, a distance of 55.02 feet to a 5/8 inch iron rod found on the southwest corner of Lot 4953 of Fred Carter Park (Plat Cabinet B, Slides 108B-109A).

THENCE, with the south line of Lot 4953 and the south line of the City of Bellefontaine original 5.50 acre tract (O.R. 207, Pg. 453), S 86°-20'-06"E, a distance of 226.39 feet to a 5/8 inch iron rod found on the west line of Lot 4597 of Glenwood East Allotment III (Plat Cabinet A, Slide 745B).

THENCE, with the west lines of Lot 4597 and Lot 4557 of Glenwood East Allotment II, S 05°-02'-20"W, a distance of 93.86 feet to a chiseled "x" found on a concrete wall on the south line of Virginia Military Survey 4399, the west line of Lot 4557 and the northeast corner of Lot 4558.

THENCE, with the south line of Virginia Military Survey 4399 and the north lines of Lots 4558 and 4559, N 86°-43'-49"W, a distance of 202.05 feet to the point of beginning.

Containing 0.466 acre.

Property is subject to any and all previous easements and rights-of-way of record.

The basis for bearings is the south line of Virginia Military Survey 4399, being N 86°-43'-49"W, and all other bearings are from angles and distances measured in a field survey by Lee Surveying and Mapping Co., Inc. on September 9, 2013.



Description prepared by:

William K. Bruce

William K. Bruce
Professional Surveyor 7437
September 10, 2013
Revised September 18, 2013

1070813REV



CURVE	DELTA ANGLE	RADIUS	ARC LENGTH	CHORD BEARING	CHORD LENGTH
C1	01°33'30"	570.00'	15.50'	N 09°58'38" W	15.50'

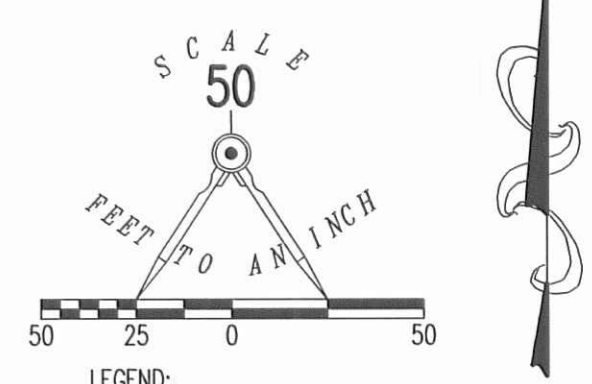

- LEGEND:
- ☒ CHISELED "X" FOUND ON CONCRETE WALL
 - 5/8 INCH IRON ROD FOUND
 - 5/8 INCH IRON ROD SET WITH PLASTIC I.D. CAP STAMPED "LSM 7437"

**SURVEY OF 0.466 ACRE OUT OF THE
LA ROSS, LLC
ORIGINAL 33.612 ACRE TRACT
OFFICIAL RECORD 959, PAGE 669
PARCEL I
VIRGINIA MILITARY SURVEY 4399
CITY OF BELLEFONTAINE
LAKE TOWNSHIP
LOGAN COUNTY, OHIO**

SURVEYED BY:

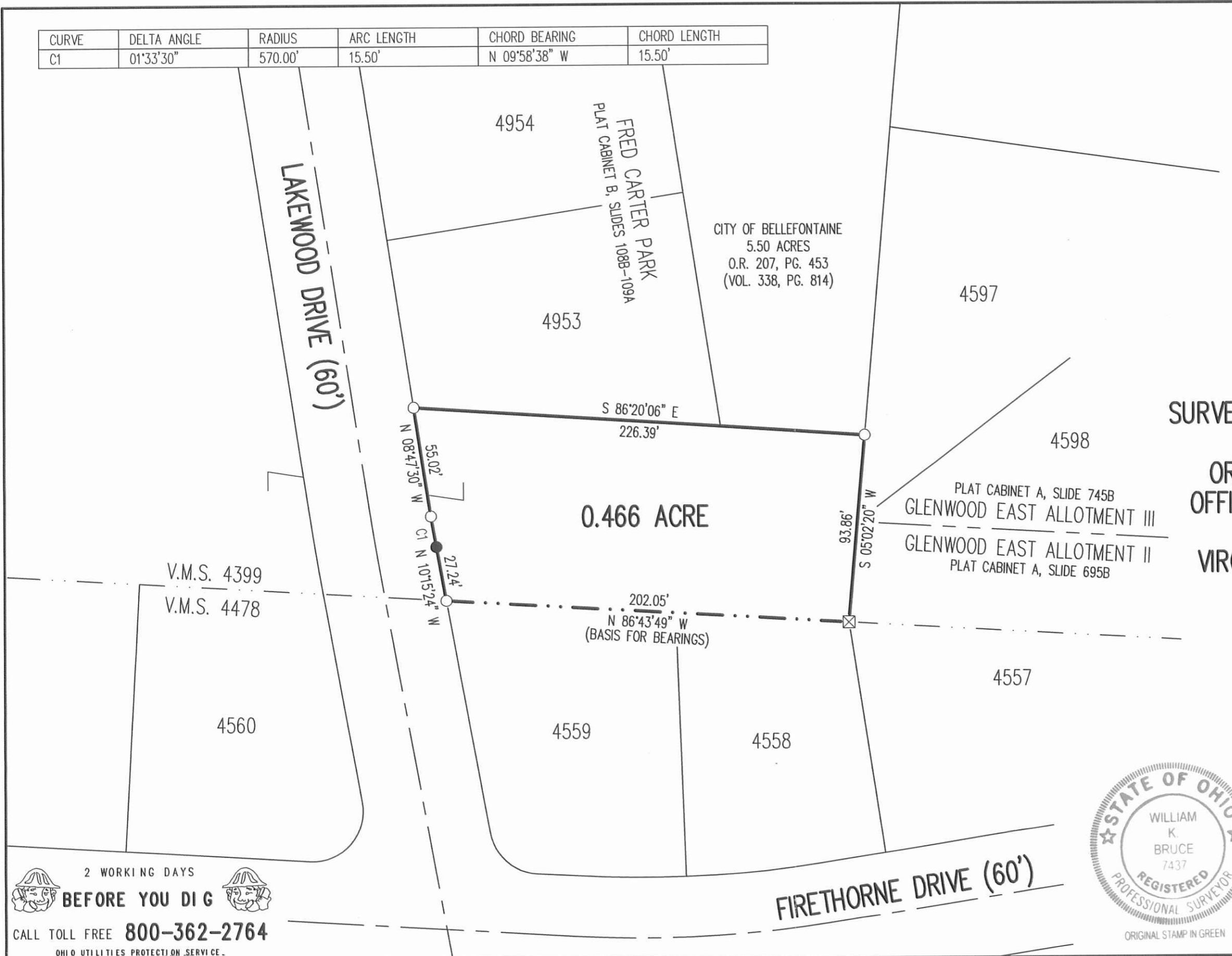

William K. Bruce
WILLIAM K. BRUCE
PROFESSIONAL SURVEYOR 7437
SEPTEMBER 9, 2013
REVISED SEPTEMBER 18, 2013 TO REVISE FRED CARTER
PARK LOT NUMBERS.



COPYRIGHT 2013 BY:
LEE SURVEYING & MAPPING CO., INC.
117 North Madriver Street
BELLEFONTAINE, OHIO 43311
(937) 593-7335
WWW.LSMINC.US
surveys@lsminc.us
KSS D0813 1070813REV L-107-3

2 WORKING DAYS
BEFORE YOU DIG
CALL TOLL FREE **800-362-2764**
OHIO UTILITIES PROTECTION SERVICE.

APPROVED
9/20/13
INDEXED ON MAP
6947 9P



5-10-16
APPROVED

Lee Surveying and Mapping Co., Inc.

Land Surveys • Topography • Subdivisions • Construction Layout

117 N. Madriver St.
Bellefontaine OH 43311



Phone: (937) 593-7335
Fax: (937) 593-7444
surveys@lsmcinc.us

LA ROSS, LLC 21.449 ACRES

Lying in Virginia Military Survey 4399, City of Bellefontaine, Lake Township, Logan County, Ohio.

Being out of the LA Ross, LLC, 33.612 acre tract and all of the 0.008 acre tract, the 0.303 acre tract, the 0.090 acre tract and 0.917 acre tract (being part of Lot 4338 of Hyland Hills Estates Phase V, recorded in Plat Cabinet A, Slide 563) as deeded and described in Official Record 959, Page 669, Parcel I, Parcel II, Tracts I, II, III and Parcel III of the Logan County Records of Deeds and being more particularly described as follows:

Beginning on a concrete monument found on the northwest corner of Westerman Allotment 2 (Plat Cabinet A, Slide 609) on the south line of Virginia Military Survey 4399.

THENCE, with the south line of Virginia Military Survey 4399, N 86°-43'-49"W, a distance of 1156.11 feet to a 5/8 inch iron rod set on the easterly line of Deer Run #1 (Plat Cabinet A, Slides 691A, 691B & 693A).

THENCE, with the easterly line of Deer Run #1, N 41°-26'-42"E, a distance of 289.10 feet to a 5/8 inch iron rod found.

THENCE, with the lines of the Roger A. Saul 0.966 acre part of Lot 4338 of Hyland Hills Estate Phase 5 (Plat Cabinet A, Slide 563) (O.R. 140, Pg. 737, Tract II), the following three courses:

N 82°-52'-16"E, a distance of 271.33 feet to a 5/8 inch iron rod found.

N 02°-16'-25"E, a distance of 134.03 feet to a 5/8 inch iron rod found.

N 88°-43'-39"W, a distance of 49.26 feet to a steel fence post found.

THENCE, with the east line of the Michael A. Renne, Trustee part of said Lot 4338 (O.R. 1147, Pg. 316, Tract I), N 01°-45'-28"E, a distance of 193.51 feet to a 1 inch iron pipe found.

THENCE, with the south lines of the Everson Enterprises II, LLC 1.473 acre tract (O.R. 687, Pg. 103, Tract I & II and the Red Bud Hill, Ltd.

INDEXED ON MAP
6947 10D-1

Lee Surveying and Mapping Co., Inc.

Land Surveys • Topography • Subdivisions • Construction Layout

117 N. Madriver St.
Bellefontaine OH 43311



Phone: (937) 593-7335
Fax: (937) 593-7444
surveys@lsminc.us

Original 3.749 acre tract (O.R. 12, Pg. 167), N 89°-16'-45"E, a distance of 343.99 feet to a 5/8 inch iron rod set.

THENCE, with the south line of the Lakewood Terrace Condominiums (Plat Cabinet B, Slides 11A – 15A), S 88°-52'-37"E, a distance of 415.84 feet to a 5/8 inch iron rod found.

THENCE, with the south line of the Buckeye Community Twenty Five, LP, 4.592 acre tract (O.R. 1072, Pg. 861), S 88°56'-00"E, a distance of 462.37 feet to a MAG nail found in top of railroad tie post on the southwest corner of Virginia Military Survey 3683.

THENCE, with the lines of the Village of Bellefontaine, Ohio 5.70 acre tract (Vol. 65, Pg. 634), the following two courses:

N 77°-45'-46"E, a distance of 41.08 feet to a 5/8 inch iron rod found.

N 85°-46'-29"E, a distance of 18.51 feet to a 5/8 inch iron rod found.

THENCE, with the westerly right-of-way of Lakewood Drive (Variable widths), the following fifteen courses:

With a curve to the right, having a central angle of 56°-40'-05", a radius of 25.00 feet, an arc length of 24.73 feet and a chord bearing S 21°-46'-35"W, a distance of 23.73 feet to a 5/8 inch iron rod found.

S 50°-06'-04"W, a distance of 7.44 feet to a 5/8 inch iron rod found.

S 08°-49'-11"E, a distance of 70.06 feet to a 5/8 inch iron rod found.

N 50°-06'-04"E, a distance of 1.02 feet to a 5/8 inch iron rod set.

With a curve to the right, having a central angle of 117°-15'-17", a radius of 25.00 feet, an arc length of 51.16 feet and a chord bearing S 71°-16'-05"E, a distance of 42.69 feet to a 5/8 inch iron rod found.

With a curve to the right, having a central angle of 03°-49'-05", a radius of 574.00 feet, an arc length of 38.25 feet and a chord bearing S 10°-44'-04"E, a distance of 38.24 feet to a 5/8 inch iron rod found.

S 08°-49'-11"E, a distance of 251.91 feet to a 5/8 inch iron rod found.

With a curve to the right, having a central angle of 90°-00'-00", a radius of 25.00 feet, an arc length of 39.27 feet and a chord bearing S 36°-10'-49"W, a distance of 35.36 feet to a 5/8 inch iron rod found.

Lee Surveying and Mapping Co., Inc.

Land Surveys • Topography • Subdivisions • Construction Layout

117 N. Madriver St.
Bellefontaine OH 43311

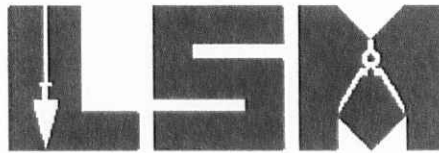

Phone: (937) 593-7335
Fax: (937) 593-7444
surveys@lsminc.us

S 81°-10'-49"W, a distance of 15.00 feet to a 5/8 inch iron rod found.

S 08°-49'-11"E, a distance of 60.00 feet to a 5/8 inch iron rod found.

N 81°-10'-49"E, a distance of 15.00 feet to a 5/8 inch iron rod found.

With a curve to the right, having a central angle of 90°-00'-34", a radius of 25.00 feet, an arc length of 39.27 feet and a chord bearing

S 53°-48'-50"E, a distance of 35.36 feet to a 5/8 inch iron rod set.

S 08°-49'-11"E, a distance of 149.47 feet to a 5/8 inch iron rod found.

With a curve to the left, having a central angle of 01°-33'-35", a radius of 630.00 feet, an arc length of 17.15 feet and a chord bearing

S 09°-35'-58"E, a distance of 17.15 feet to a 5/8 inch iron rod found.

S 11°-17'-29"E, a distance of 12.42 feet to a point on the south line of Virginia Military Survey 4399 on the northeast corner of Lot 4560 of Glennwood East Allotment II (Plat Cabinet A, Slide 695B), referenced by a 5/8 inch iron rod found bearing S 11°-17'-29"E, a distance of 1.45 feet.

THENCE, with the south line of Virginia Military Survey 4399 and the north lines of said Lot 4560, Westerman Allotment 3 (Plat Cabinet A, Slide 625) and the aforesaid Westerman Allotment 2, N 86°-43'-49"W, a distance of 678.35 feet to the point of beginning.

Containing 21.449 acres.

Property is subject to any and all previous easements and rights-of-way of record.

The basis for bearings is the west right-of-way of Lakewood Drive, being S 08°-49'-11"E, and all other bearings are from angles and distances measured in a field survey by Lee Surveying and Mapping Co., Inc. on April 27, 2016.

Description prepared by:

A handwritten signature in black ink that reads 'William K. Bruce'.

William K. Bruce
Professional Surveyor 7437
April 28, 2016



ORIGINAL STAMP IN GREEN

1070316

INDEXED ON MAP

6947 10D-3

LEGEND:

- ⊕ 1 INCH IRON PIPE FOUND
- ⊙ MAG NAIL FOUND IN TOP OF RAILROAD TIE POST
- ⊠ CONCRETE MONUMENT FOUND
- ⊗ STEEL FENCE POST FOUND
- 5/8 INCH IRON ROD FOUND
- 5/8 INCH IRON ROD SET WITH PLASTIC I.D. CAP STAMPED "LSM 7437"

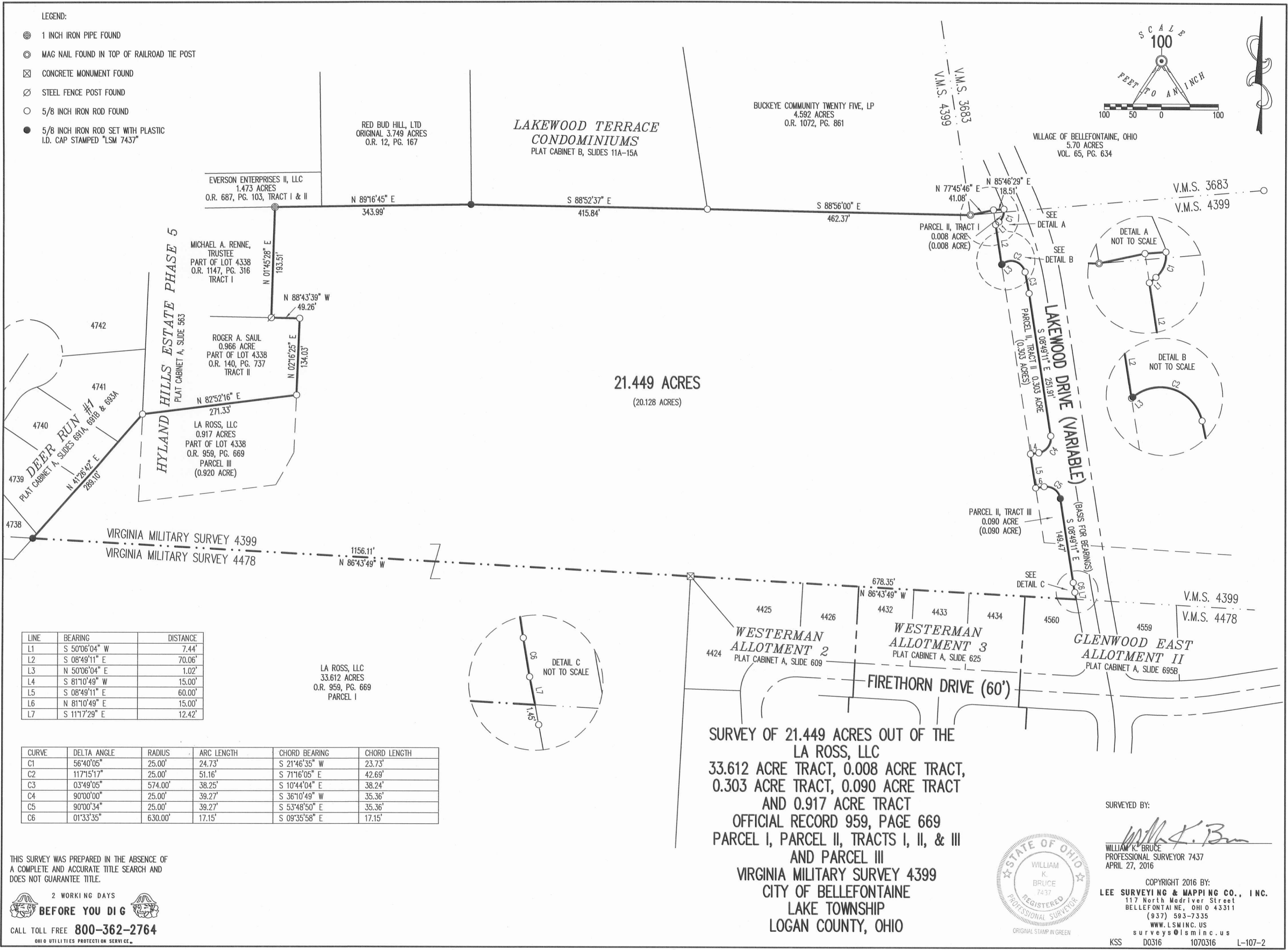
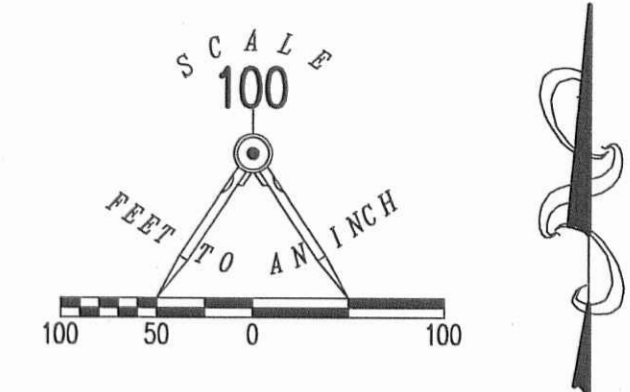

LINE	BEARING	DISTANCE
L1	S 50°06'04" W	7.44'
L2	S 08°49'11" E	70.06'
L3	N 50°06'04" E	1.02'
L4	S 81°10'49" W	15.00'
L5	S 08°49'11" E	60.00'
L6	N 81°10'49" E	15.00'
L7	S 11°17'29" E	12.42'

CURVE	DELTA ANGLE	RADIUS	ARC LENGTH	CHORD BEARING	CHORD LENGTH
C1	56°40'05"	25.00'	24.73'	S 21°46'35" W	23.73'
C2	117°15'17"	25.00'	51.16'	S 71°16'05" E	42.69'
C3	03°49'05"	574.00'	38.25'	S 10°44'04" E	38.24'
C4	90°00'00"	25.00'	39.27'	S 36°10'49" W	35.36'
C5	90°00'34"	25.00'	39.27'	S 53°48'50" E	35.36'
C6	01°33'35"	630.00'	17.15'	S 09°35'58" E	17.15'

THIS SURVEY WAS PREPARED IN THE ABSENCE OF A COMPLETE AND ACCURATE TITLE SEARCH AND DOES NOT GUARANTEE TITLE.

2 WORKING DAYS
BEFORE YOU DIG
CALL TOLL FREE **800-362-2764**
OHIO UTILITIES PROTECTION SERVICE

SURVEY OF 21.449 ACRES OUT OF THE LA ROSS, LLC 33.612 ACRE TRACT, 0.008 ACRE TRACT, 0.303 ACRE TRACT, 0.090 ACRE TRACT AND 0.917 ACRE TRACT OFFICIAL RECORD 959, PAGE 669 PARCEL I, PARCEL II, TRACTS I, II, & III AND PARCEL III VIRGINIA MILITARY SURVEY 4399 CITY OF BELLEFONTAINE LAKE TOWNSHIP LOGAN COUNTY, OHIO



SURVEYED BY:
William K. Bruce
WILLIAM K. BRUCE
PROFESSIONAL SURVEYOR 7437
APRIL 27, 2016

COPYRIGHT 2016 BY:
LEE SURVEYING & MAPPING CO., INC.
117 North Madriver Street
BELLEFONTAINE, OHIO 43311
(937) 593-7335
WWW.LSMINC.US
surveys@lsminc.us
KSS D0316 1070316 L-107-2

INDEXED ON MAP
6947 10P

3-17-17

Lee Surveying and Mapping Co., Inc.



Land Surveys • Topography • Subdivisions • Construction Layout

117 N. Madriver St.
Bellefontaine OH 43311



Phone: (937) 593-7335
Fax: (937) 593-7444
surveys@lsmcinc.us

MICHAEL A. RENNE, TRUSTEE 20.128 ACRES (FOR EXCEPTION PURPOSES ONLY)

Lying in Virginia Military Survey 4399, City of Bellefontaine, Lake Township, Logan County, Ohio.

Being out of the Michael A. Renne, Trustee, 21.449 acre tract as deeded and described in Official Record 1220, Page 139, of the Logan County Records of Deeds and being more particularly described as follows:

Beginning on a concrete monument found on the northwest corner of Westerman Allotment 2 (Plat Cabinet A, Slide 609) on the south line of Virginia Military Survey 4399.

THENCE, with the south line of Virginia Military Survey 4399, N 86°-43'-49"W, a distance of 1156.11 feet to a 5/8 inch iron rod set on the easterly line of Deer Run #1 (Plat Cabinet A, Slides 691A, 691B & 693A).

THENCE, with the easterly line of Deer Run #1, N 41°-26'-42"E, a distance of 289.10 feet to a 5/8 inch iron rod found.

THENCE, with the lines of Lot 4338 of Highland Hills Estate Phase 5 (Plat Cabinet A, Slide 563) the following four courses:

S 02°-31'-21"W, a distance of 152.48 feet to a 5/8 inch iron rod found.

N 82°-53'-35"E, a distance of 242.27 feet to a 5/8 inch iron rod found.

N 29°-05'-19"E, a distance of 64.57 feet to a 5/8 inch iron rod found.

N 02°-16'-51"E, a distance of 99.66 feet to a 5/8 inch iron rod found.

THENCE, with the lines of the Roger A. Saul 0.966 acre part of Lot 4338 (O.R. 140, Pg. 737, Tract II), the following two courses:

N 02°-16'-25"E, a distance of 134.03 feet to a 5/8 inch iron rod found.

N 88°-43'-39"W, a distance of 49.26 feet to a steel fence post found.

INDEXED ON MAP
6947 IID-1

Lee Surveying and Mapping Co., Inc.

Land Surveys • Topography • Subdivisions • Construction Layout

117 N. Madriver St.
Bellefontaine OH 43311



Phone: (937) 593-7335
Fax: (937) 593-7444
surveys@lsminc.us

THENCE, with the east line of the Michael A. Renne, Trustee part of said Lot 4338 (O.R. 1147, Pg. 316, Tract I), N 01°-45'-28"E, a distance of 193.51 feet to a 1 inch iron pipe found.

THENCE, with the south lines of the Everson Enterprises II, LLC 1.473 acre tract (O.R. 687, Pg. 103, Tract I & II and the Red Bud Hill, Ltd., original 3.749 acre tract (O.R. 12, Pg. 167), N 89°-16'-45"E, a distance of 343.99 feet to a 5/8 inch iron rod set.

THENCE, with the south line of the Lakewood Terrace Condominiums (Plat Cabinet B, Slides 11A – 15A), S 88°-52'-37"E, a distance of 415.84 feet to a 5/8 inch iron rod found.

THENCE, with the south line of the Buckeye Community Twenty Five, LP, 4.592 acre tract (O.R. 1072, Pg. 861), S 88°56'-00"E, a distance of 462.37 feet to a MAG nail found in top of railroad tie post on the southwest corner of Virginia Military Survey 3683.

THENCE, with the south line of the Village of Bellefontaine, Ohio 5.70 acre tract (Vol. 65, Pg. 634), N 77°-45'-46"E, a distance of 41.08 feet to a 5/8 inch iron rod found.

THENCE, S 08°-49'-11"E, a distance of 587.20 feet to a 5/8 inch iron rod found.

THENCE, S 86°-20'-06"E, a distance of 40.97 feet to a point on the westerly right-of-way of Lakewood Drive (variable widths), referenced by a 5/8 inch iron rod set, bearing N 08°-49'-11"W, a distance of 80.89 feet.

THENCE, with the westerly right-of-way of Lakewood Drive, the following three courses:

S 08°-49'-11"E, a distance of 68.58 feet to a 5/8 inch iron rod found.

With a curve to the left, having a central angle of 01°-33'-35", a radius of 630.00 feet, an arc length of 17.15 feet and a chord bearing S 09°-35'-58"E, a distance of 17.15 feet to a 5/8 inch iron rod found.

S 11°-17'-29"E, a distance of 12.42 feet to a point on the south line of Virginia Military Survey 4399 on the northeast corner of Lot 4560 of Glennwood East Allotment II (Plat Cabinet A, Slide 695B), referenced by a 5/8 inch iron rod found bearing S 11°-17'-29"E, a distance of 1.45 feet.

INDEXED ON MAP
0947 IID-2

Lee Surveying and Mapping Co., Inc.

Land Surveys • Topography • Subdivisions • Construction Layout

117 N. Madriver St.
Bellefontaine OH 43311



Phone: (937) 593-7335
Fax: (937) 593-7444
surveys@lsminc.us

THENCE, with the south line of Virginia Military Survey 4399 and the north lines of said Lot 4560, Westerman Allotment 3 (Plat Cabinet A, Slide 625) and the aforesaid Westerman Allotment 2, N 86°-43'-49"W, a distance of 678.35 feet to the point of beginning.

Containing 20.128 acres.

Property is subject to any and all previous easements and rights-of-way of record.

The basis for bearings is the west right-of-way of Lakewood Drive, being S 08°-49'-11"E, and all other bearings are from angles and distances measured in a field survey by Lee Surveying and Mapping Co., Inc. on April 27, 2016.

Description prepared by:

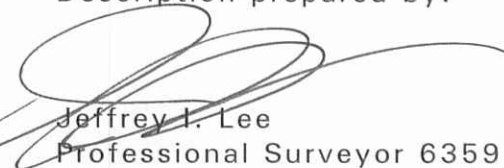

Jeffrey I. Lee
Professional Surveyor 6359
March 1, 2017

1070217

ORIGINAL STAMP IN GREEN

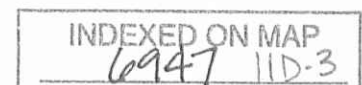

LEGEND:

- ⊕ 1 INCH IRON PIPE FOUND
- ⊙ MAG NAIL FOUND IN TOP OF RAILROAD TIE POST
- ⊠ CONCRETE MONUMENT FOUND
- ⊗ STEEL FENCE POST FOUND
- 5/8 INCH IRON ROD FOUND
- 5/8 INCH IRON ROD SET WITH PLASTIC I.D. CAP STAMPED "LSM 7437"

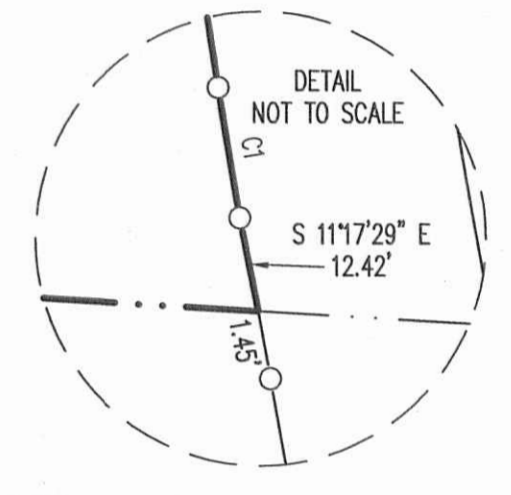
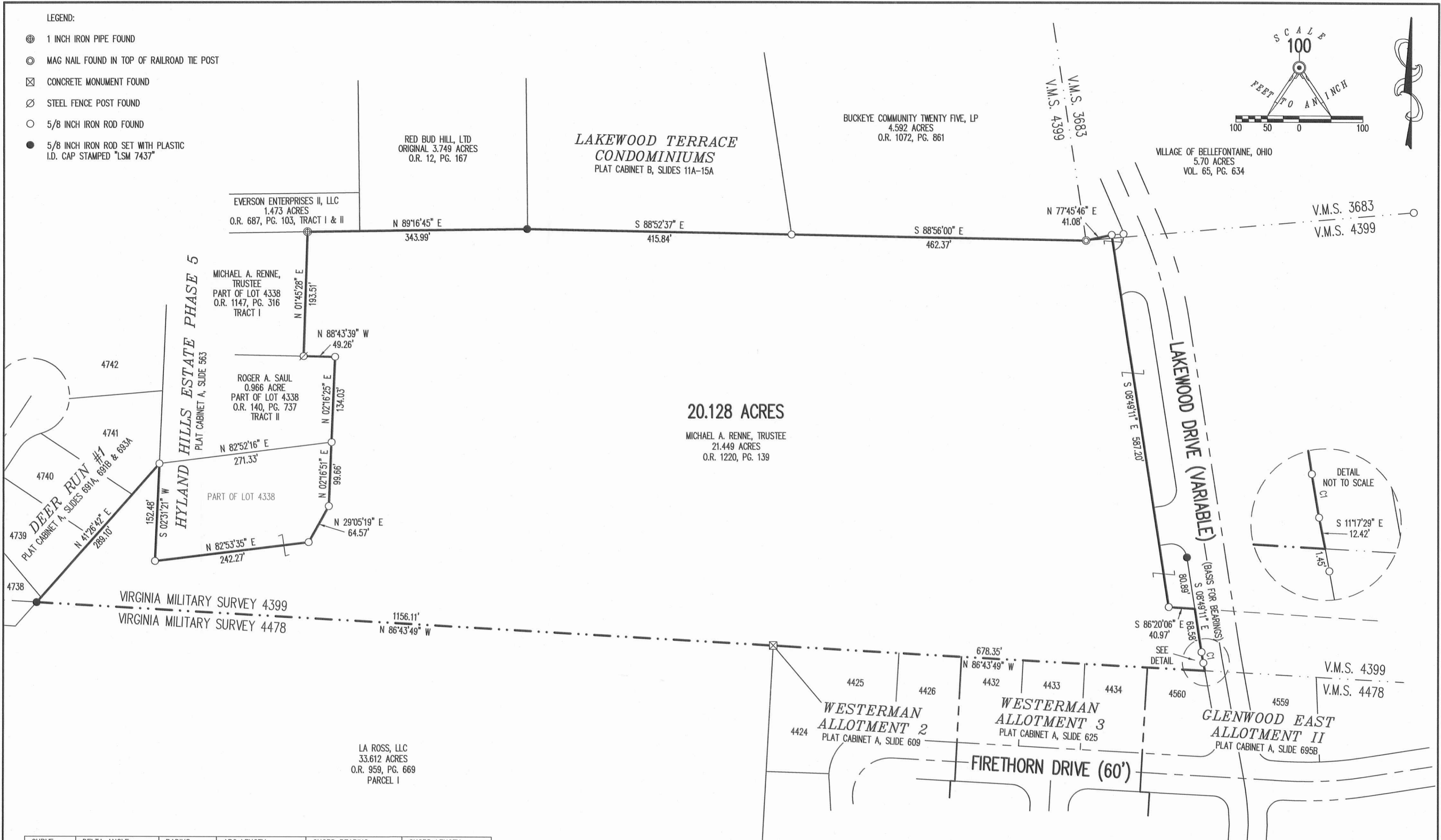
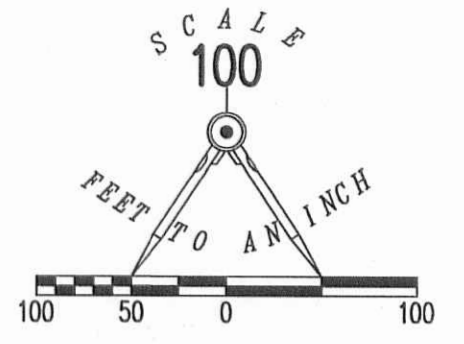

CURVE	DELTA ANGLE	RADIUS	ARC LENGTH	CHORD BEARING	CHORD LENGTH
C1	01°33'35"	630.00'	17.15'	S 09°35'58" E	17.15'

THIS SURVEY WAS PREPARED IN THE ABSENCE OF A COMPLETE AND ACCURATE TITLE SEARCH AND DOES NOT GUARANTEE TITLE.

2 WORKING DAYS
BEFORE YOU DIG
CALL TOLL FREE 800-362-2764
OHIO UTILITIES PROTECTION SERVICE

SURVEY OF 20.128 ACRES (FOR EXCEPTION PURPOSES ONLY) OUT OF THE MICHAEL A. RENNE, TRUSTEE 21.449 ACRE TRACT OFFICIAL RECORD 1220, PAGE 139 VIRGINIA MILITARY SURVEY 4399 CITY OF BELLEFONTAINE LAKE TOWNSHIP LOGAN COUNTY, OHIO

SURVEYED BY:
[Signature]
JEFFREY L. LEE
PROFESSIONAL SURVEYOR 6359
APRIL 27, 2016
REVISED FEBRUARY 28, 2017 (FOR EXCEPTION PURPOSES ONLY, NO FURTHER FIELD WORK CONDUCTED)



COPYRIGHT 2017 BY:
LEE SURVEYING & MAPPING CO., INC.
117 North Madriver Street
BELLEFONTAINE, OHIO 43311
(937) 593-7335
WWW.LSMINC.US
surveys@lsminc.us
KSS D0217 1070217 L-107-2

11-9-07

 APPROVED

**SURVEY FOR EVERSON ENTERPRISES II, LLC
0.076 Acre, October 19, 2017**

The following described 0.076 acre tract is situated in the State of Ohio, County of Logan, Township of Lake, City of Bellefontaine, V.M.S. 4399, being part of the remainder of Everson Enterprises II, LLC's original 8.04 acre Tract I described in Official Record 687, page 103, and said 0.076 acre tract being particularly described as follows:

Beginning for reference at a 5/8 inch iron pin found at the northeast corner of Lot 4034 of Eastwood Allotment recorded in Plat Cabinet A, slide 347, and in the south line of Sandusky Street (60 feet wide);

Thence North 74°29'35" East 165.78 feet, following the south line of Sandusky Street, and passing at 124.14 feet a 3/8 inch iron pin found at the northwest corner of the City of Bellefontaine, Ohio's 1.000 acre tract described in Official Record 1274, page 96 (1.000 acre tract acquired for Shady Lane Drive, variable right of way), thereafter crossing the north end of Shady Lane Drive and following a north line of part of the remainder of said original 8.04 acre tract, to a 1 inch iron pin found in the west line of Daniel W. Ashcraft's 0.029 acre Tract II described in Official Record 899, page 102;

Thence South 4°09'24" West 147.84 feet, departing from the south right of way line of Sandusky Street, following an east line of part of the remainder of said original 8.04 acre tract, and the west line of said 0.029 acre tract, to a 5/8 inch iron pin found with cap marked "NOTESTINE S 7815", at an angle point in the east line of Shady Lane Drive;

Thence North 74°44'17" East 8.59 feet, following a south line of said 0.029 acre tract and a south line of Daniel W. Ashcraft's 30/100 acre Tract I described in Official Record 899, page 102, to a 5/8 inch iron pin found with cap marked "NOTESTINE S 7815" at a northwest corner of part of the remainder of said original 8.04 acre tract, said iron pin marking the *place of beginning*;

Thence *North 74°44'17" East 74.80 feet*, following a north line of part of the remainder of said original 8.04 acre tract and the south line of said 30/100 acre tract, to a 3/4 inch iron pipe found at the southwest corner of Red Bud Hill Ltd.'s 0.289 acre tract described in Official Record 12, page 175 and at the northwest corner of Red Bud Hill, Ltd's 3.749 acre tract described in Official Record 12, page 167;

Thence *South 3°50'55" West 59.29 feet*, following an east line of part of the remainder of said original 8.04 acre tract and a west line of said 3.749 acre tract, to a magnetic nail set in a concrete pad, said magnetic nail being in the north line of Everson Enterprises II, LLC's 1.101 acre Tract III described in Official Record 687, page 103;

Thence *North 86°18'53" West 70.58 feet*, following a south line of part of the remainder of said original 8.04 acre tract and the north line of said 1.101 acre tract, to an iron pin set in the east line of Shady Lane Drive;

Thence *North 3°41'02" East 35.00 feet*, following the east right of way line of Shady Lane Drive and a west line of part of the remainder of said original 8.04 acre tract, to the *place of beginning, containing 0.076 acre*, more or less, and being subject to all valid easements and restrictions of record.

The above description was prepared from a field survey made under the supervision of Paul R. Clapsaddle, Registered Surveyor #6140, during the month of October 2017. Bearings indicated herein are based on an assumed meridian with all others based on angles turned. Iron pins set are 5/8 inch by 30 inch reinforcing rods with caps marked "CLAPSADDLE RS #6140".

ATTEST: Paul R. Clapsaddle
Paul R. Clapsaddle, R.S. #6140
19019 West Darby Road, Marysville, Ohio
(937) 747-2599

INDEXED ON MAP
6947 12

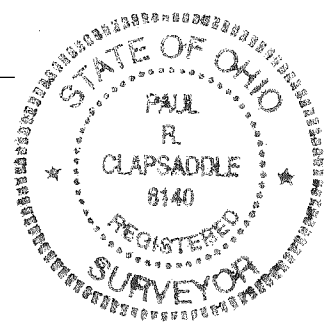

11-9-07

APPROVED

SURVEY FOR EVERSON ENTERPRISES II LLC

STATE OF OHIO
COUNTY OF LOGAN
TOWNSHIP OF LAKE
CITY OF BELLEFONTAINE
V.M.S. 4399

Reference Beginning
northeast corner Lot 4034
Eastwood Allotment
Plat Cabinet A, Slide 347

SANDUSKY STREET (60')

Lot 4034

Everson Enterprises II, LLC
part of the remainder of
an original 8.04 acre Tract I
O.R. 687, Pg. 103

The City of Bellefontaine, Ohio
1.000 acre
Shady Lane Drive
acquired for road purposes
O.R. 1274, Pg. 96

NOTES:

Reference deeds are shown hereon
Bearings indicated hereon are based on
an assumed meridian with all others
based on angles turned

LEGEND:

- 5/8 inch iron pin found
- 3/8 inch iron pin found
- ⊙ 1 inch iron pin found
- ⦿ 5/8 inch iron pin found with cap marked "Notestine S. 7815"
- 5/8 inch iron pin set with cap marked "CLAPSADDLE RS 6140"
- ⊕ 3/4 inch iron pipe found
- Magnetic nail set in concrete pad

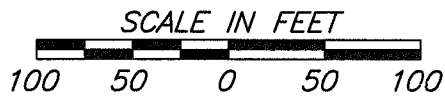

Date: October 19, 2017 Drawing: EversonJ0.076ac1017
Scale: 1"=100' Project: EversonJ1017

**Paul R. Clapsaddle
and Associates**

REGISTERED ENGINEERS AND SURVEYORS

19019 WEST DARBY ROAD, MARYSVILLE OHIO 43040
(937) 747-2599

Paul R. Clapsaddle, P.E., P.S.

Daniel W. Ashcraft
0.029 acre Tract II
O.R. 899, Pg. 102

Daniel W. Ashcraft
30/100 acre Tract I
O.R. 899, Pg. 102

Red Bud Hill Ltd.
0.289 acre
O.R. 12, Pg. 175

SHADY LANE DRIVE
(variable right of way)

City of Bellefontaine
1.000 acre
O.R. 1274, Pg. 96

0.076 Acre
Part of the remainder
of Everson Enterprises II,
LLC's original
8.04 acre Tract I
described in
O.R. 687, Pg. 103

Everson Enterprises II, LLC
1.101 acres, Tract III
O.R. 687, Pg. 103

Red Bud Hill, Ltd.
3.749 acres
O.R. 12, Pg. 167



I hereby certify that this plat was prepared from
a field survey made under my supervision and that
monuments were placed as indicated hereon.

Paul R. Clapsaddle
Paul R. Clapsaddle, R.S. #6140

INDEXED ON MAP
6947 12

11-9-07

APPROVED

SURVEY FOR EVERSON ENTERPRISES II, LLC

0.212 Acre

October 19, 2017

The following described 0.212 acre tract is situated in the State of Ohio, County of Logan, Township of Lake, City of Bellefontaine, V.M.S. 4399, being part of the remainder of Everson Enterprises II, LLC's original 8.04 acre Tract I described in Official Record 687, page 103, and said 0.212 acre tract being more particularly described as follows:

Beginning at a 5/8 inch iron pin found at the northeast corner of Lot 4338 of Hyland Hills Estates Phase 5 recorded in Plat Cabinet A, Slide 563, at an angle point in the south line of said original 8.04 acre tract, at the northeast corner of Michael A. Renne, Trustee's part of Lot 4338 Tract I described in Official Record 1147, page 316, and at the northwest corner of Michael A. Renne, Trustee's 21.449 acre tract described in Official Record 1220, page 139, said iron pin marking the *place of beginning*;

Thence *North 86°21'49" West (assumed bearing) 84.27 feet*, following a south line of said original 8.04 acre tract and the north line of said part of Lot 4338, to a 5/8 inch iron pin found with cap marked "NOTESTINE S. 7815" at the southeast corner the City of Bellefontaine, Ohio's 1.000 acre tract described in Official Record 1274, page 96 (1.000 acre tract acquired for Shady Lane Drive, variable right of way width);

Thence *North 3°41'02" East 57.95 feet*, following the east right of way line of Shady Lane Drive and a west line of part of the remainder of said original 8.04 acre tract, to a 5/8 inch iron pin found at the southwest corner of Everson Enterprises II, LLC's 1.62 acre Tract IV described in Official Record 687, page 103;

Thence *South 85°35'35" East 164.98 feet*, following a north line of part of the remainder of said original 8.04 acre tract and the south line of said 1.62 acre tract, to an iron pin set in the west line of Red Bud Hill, Ltd.'s 3.749 acre tract described in Official Record 12, page 167;

Thence *South 3°41'36" West 52.61 feet*, following an east line of part of the remainder of said original 8.04 acre tract and the west line of said 3.749 acre tract, to a 5/8 inch iron pin found in the north line of said 21.449 acre tract;

Thence *North 88°34'28" West 80.75 feet*, following a south line of said original 8.04 acre tract and the north line of said 21.449 acre tract, to the *place of beginning, containing 0.212 acre*, more or less, and being subject to all valid easements and restrictions of record.

The above description was prepared from a field survey made under the supervision of Paul R. Clapsaddle, Registered Surveyor #6140, during the month of October 2017. Bearings indicated herein are based on an assumed meridian with all others based on angles turned. Iron pins set are 5/8 inch by 30 inch reinforcing rods with caps marked "CLAPSADDLE RS #6140".

ATTEST: 

Paul R. Clapsaddle, R.S. #6140
19019 West Darby Road
Marysville, Ohio
(937) 747-2599

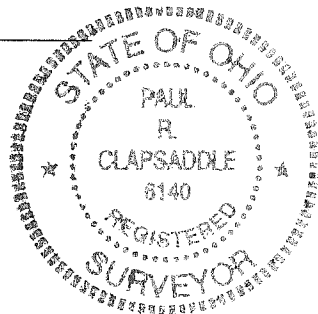

INDEXED ON MAP
694713

11-9-07

APPROVED

SURVEY FOR EVERSON ENTERPRISES II LLC

STATE OF OHIO
COUNTY OF LOGAN
TOWNSHIP OF LAKE
CITY OF BELLEFONTAINE
V.M.S. 4399

NOTES:

Reference deeds are shown hereon
Bearings indicated hereon are based on
an assumed meridian with all others
based on angles turned

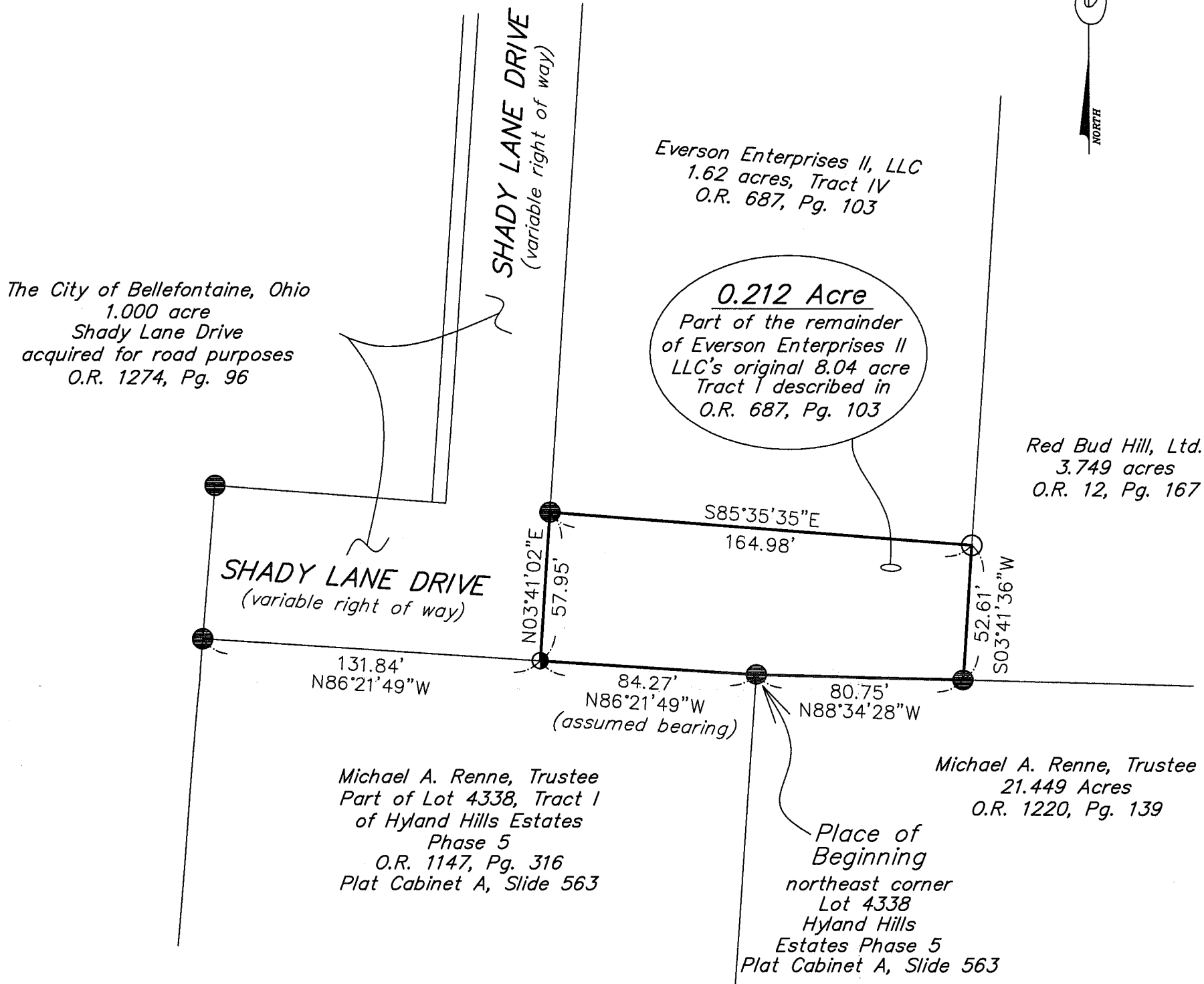

LEGEND:

- 5/8 inch iron pin found
- ⊙ 5/8 inch iron pin found with cap marked "Notestine S. 7815"
- 5/8 inch iron pin set with cap marked "CLAPSADDLE RS 6140"



Date: October 19, 2017 Drawing: EversonJ0.212acOct17
Scale: 1"=100' Project: EversonJ1017



**Paul R. Clapsaddle
and Associates**
REGISTERED ENGINEERS AND SURVEYORS
19019 WEST DARBY ROAD, MARYSVILLE OHIO 43040
(937) 747-2599

Paul R. Clapsaddle, P.E., P.S.

I hereby certify that this plat was prepared from
a field survey made under my supervision and that
monuments were placed as indicated hereon.

Paul R. Clapsaddle
Paul R. Clapsaddle, R.S. #6140

INDEXED ON MAP
6947 13