

1  
RECID 2-9-04 SMJ DL

# Lee Surveying and Mapping Co., Inc.

Land Surveys • Topography • Subdivisions • Construction Layout

117 N. Madriver St.  
Bellefontaine OH 43311



Phone: (937) 593-7335  
Fax: (937) 593-7444

## MAIN BELLE LLC. 0.429 ACRE

Lying in Section 32, Town 4, Range 14, Liberty Township, City of Bellefontaine, Logan County, Ohio

Being out of the Main Belle LLC. original 1.836 acre tract as deeded and described in Official Record 674, Page 845 of the Logan County Records of Deeds and being more particularly described as follows:

Beginning at the railroad spike found at the intersection of center-lines of South Main Street (80 feet wide) and Gunntown Road (60 feet wide).

THENCE, with the center-line of U.S. Route 68, S 4°-10'-00"E, a distance of 222.16 feet to a P.K. nail found.

THENCE, with the north line of the City of Bellefontaine 0.190 acre tract (O.R. 291, Pg. 557), S 85°-50'-00"W, a distance of 40.00 feet to a 5/8 inch iron rod found.

THENCE, with the west line of the said 0.190 acre tract, S 4°-10'-00"E, a distance of 127.68 feet to a 5/8 inch iron rod set at THE TRUE POINT OF BEGINNING.

THENCE, with the west line of the said 0.190 acre tract, S 4°-10'-00"E, a distance of 55.50' to a 5/8 inch iron rod found.

THENCE, with a north line of the DDR Continental LP 8.403 acre tract (O.R. 358, Pg.183 Parcel I, Tract I), S 85°-50'-00"W, a distance of 180.00 to a 5/8 inch iron rod found.

THENCE, with the east line of the said 8.403 acre tract the following 2 courses.

1. ) With a curve to the right having a central angle of 90°-00'-01", a radius of 10.00 feet, an arc length of 15.71 feet, a chord bearing of N 49°-10'-00"W, a distance of 14.14 feet to a 5/8 inch iron rod found.

2.) N 4°-10'-00"W, a distance of 115.19 feet to a MAG nail set.

THENCE, N 85°-50'-00"E, a distance of 117.00 feet to a point.

THENCE, S 4°-10'-00"E, a distance of 69.68 feet to a point.

THENCE, N 85°-50'-00"E, a distance of 73.00 feet to the point of beginning.

Containing 0.429 acre.

The basis for bearings is the center-line of South Main Street being S 4°-10'-00"E, and all other bearings are from angles and distances measured in a field survey by Lee Surveying and Mapping Co., Inc. on January 29, 2004.



ORIGINAL STAMP IN GREEN

Description prepared by:

A handwritten signature in black ink that reads 'William K. Bruce'.

William K. Bruce  
Professional Surveyor 7437  
February 3, 2004

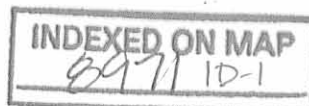

37110104

REC'D 2-9-04 SAM AL

# Lee Surveying and Mapping Co., Inc.

Land Surveys • Topography • Subdivisions • Construction Layout

117 N. Madriver St.  
Bellefontaine OH 43311



Phone: (937) 593-7335  
Fax: (937) 593-7444

## MAIN BELLE LLC. 0.370 ACRE

Lying in Section 32, Town 4, Range 14, Liberty Township, City of Bellefontaine, Logan County, Ohio

Being out of the Main Belle LLC. original 1.836 acre tract as deeded and described in Official Record 674, Page 845 of the Logan County Records of Deeds and being more particularly described as follows:

Beginning at the railroad spike found at the intersection of center-lines of South Main Street (80 feet wide) and Gunntown Road (60 feet wide).

THENCE, with the center-line of U.S. Route 68, S 4°-10'-00"E, a distance of 222.16 feet to a P.K. nail found.

THENCE, with the north line of the City of Bellefontaine 0.190 acre tract (O.R. 291, Pg. 557), S 85°-50'-00"W, a distance of 40.00 feet to a 5/8 inch iron rod found at THE TRUE POINT OF BEGINNING.

THENCE, with the west line of the said 0.190 acre tract, S 4°-10'-00"E, a distance of 127.68 feet to a 5/8 inch iron rod set.

THENCE, S 85°-50'-00"W, a distance of 73.00 feet to a point.

THENCE, N 4°-10'-00"W, a distance 69.68 feet to a point.

THENCE, S 85°-50'-00"W, a distance of 117.00 feet to a MAG nail set.

THENCE with the east line of the DDR CONTINENTAL LP 8.403 acre tract (O.R. 358, Pg. 183 Parcel I, Tract I) N 4°-10'-00"W, a distance of 58.00 feet to a 5/8 inch iron rod found.

THENCE, N 85°-50'-00"E, a distance of 190.00 feet to the point of beginning.

Containing 0.370 acre.

The basis for bearings is the center-line of South Main Street (U.S. Route 68) being S 4°-10'-00"E, and all other bearings are from angles and distances measured in a field survey by Lee Surveying and Mapping Co., Inc. on January 29, 2004.

Description prepared by:

A handwritten signature in black ink that reads "William K. Bruce".

William K. Bruce  
Professional Surveyor 7437  
February 3, 2004



ORIGINAL STAMP IN GREEN

37110104

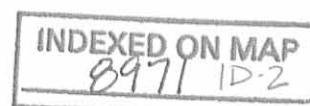

REC'D 29-04 8AM OK  
**Lee Surveying and Mapping Co., Inc.**

Land Surveys • Topography • Subdivisions • Construction Layout

117 N. Madriver St.  
Bellefontaine OH 43311

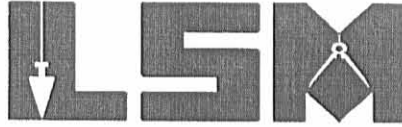

Phone: (937) 593-7335  
Fax: (937) 593-7444

**MAIN BELLE LLC.  
0.435 ACRE**

Lying in Section 32, Town 4, Range 14, Liberty Township, City of Bellefontaine, Logan County, Ohio

Being out of the Main Belle LLC. original 1.836 acre tract as deeded and described in Official Record 674, Page 845 of the Logan County Records of Deeds and being more particularly described as follows:

Beginning at the railroad spike found at the intersection of center-lines of South Main Street (80 feet wide) and Gunntown Road (60 feet wide).

THENCE, with the center-line of U.S. Route 68, S 4°-10'-00"E, a distance of 94.84 feet to a MAG nail set at THE TRUE POINT OF BEGINNING.

THENCE, with the center-line of U.S. Route 68, S 4°-10'-00"E, a distance of 127.32 feet to a P.K. nail found.

THENCE, S 85°-50'-00"W, a distance of 230.00 feet to a 5/8 inch iron rod found, passing 5/8 inch iron rods found at 30.00 feet and at 40.00 feet.

THENCE, with the east line of the DDR Continental LP 8.403 acre tract (O.R. 358, Pg. 183 Parcel I, Tract I), N 4°-10'-00"W, a distance of 40.00 feet to a MAG nail set.

THENCE, N 85°-50'-00"E, a distance of 118.50 feet to a point.

THENCE, N 4°-10'-00"W, a distance of 87.32 feet to a point.

THENCE, N 85°-50'-00"E, a distance of 111.50 feet to the point of beginning, passing a 5/8 inch iron rod set at 71.50 feet.

Containing 0.435 acre of which 0.117 acre is within the highway right-of-way.

The basis for bearings is the center-line of South Main Street being S 4°-10'-00"E, and all other bearings are from angles and distances measured in a field survey by Lee Surveying and Mapping Co., Inc. on January 29, 2004.

Description prepared by:

A handwritten signature in black ink that reads "William K. Bruce".

William K. Bruce  
Professional Surveyor 7437  
February 3, 2004



ORIGINAL STAMP IN GREEN

37110104



REV'D 2-9-04 SMY AL

# Lee Surveying and Mapping Co., Inc.

Land Surveys • Topography • Subdivisions • Construction Layout

117 N. Madriver St.  
Bellefontaine OH 43311



Phone: (937) 593-7335  
Fax: (937) 593-7444

## MAIN BELLE LLC. 0.602 ACRE

Lying in Section 32, Town 4, Range 14, Liberty Township, City of Bellefontaine, Logan County, Ohio

Being out of the Main Belle LLC. original 1.836 acre tract as deeded and described in Official Record 674, Page 845 of the Logan County Records of Deeds and being more particularly described as follows:

Beginning at the railroad spike found at the intersection of center-lines of South Main Street (80 feet wide) and Gunntown Road (60 feet wide).

THENCE, with the center-line of U.S. Route 68, S 4°-10'-00"E, a distance of 36.62 feet to a 5/8 iron rod found at THE TRUE POINT OF BEGINNING.

THENCE, with the center-line of U.S. Route 68, S 4°-10'-00"E, a distance of 58.22 feet to a MAG nail set.

THENCE, S 85°-50'-00"W, a distance of 111.50 feet to a point, passing a 5/8 inch iron rod set at 40.00 feet.

THENCE, S 4°-10'-00"E, a distance of 87.32 feet to a point.

THENCE, S 85°-50'-00"W, a distance of 118.50 feet to a MAG nail set.

THENCE, with the east line of the DDR Continental LP 8.403 acre tract (O.R. 358, Pg. 183 Parcel I, Tract I), N 4°-10'-00"W, a distance of 128.26 feet to a 5/8 inch iron rod found.

THENCE, the following 5 courses with the south line of the Lowe's Home Centers. Inc. 18.322 acre tract (O.R. 284, Pg. 303).

1.) With a curve to the left having a central angle of 12°-46'-18", a radius of 45.00 feet, an arc length of 10.03 feet, a chord bearing N 16°-53'-42"E, a distance of 10.01 feet to a 5/8 inch iron rod found.

2.) With a curve to the right having a central angle of 75°-19'-30", a radius of 30.00 feet, an arc length of 39.44 feet, a chord bearing N 48°-10'-15"E, a distance of 36.66 feet to a 5/8 inch iron rod found.

3.) N 85°-50'-00"E, a distance of 139.04 feet to a 5/8 inch iron rod found.

4.) With a curve to the right having a central angle of 54°-04'-17", a radius of 35.00 feet, an arc length of 33.03 feet, a chord bearing S 67°-07'-52"E, a distance of 31.82 feet to a 5/8 inch iron rod found.

5.) N 85°-50'-00"E, a distance of 30.00 feet to the point of beginning.

Containing 0.602 acre of which 0.055 acre is within the highway right-of-way.

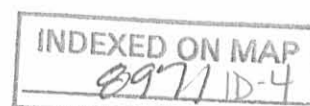

# Lee Surveying and Mapping Co., Inc.

Land Surveys • Topography • Subdivisions • Construction Layout

117 N. Madriver St.  
Bellefontaine OH 43311



Phone: (937) 593-7335  
Fax: (937) 593-7444

The basis for bearings is the center-line of South Main Street being S 4°-10'-00"E, and all other bearings are from angles and distances measured in a field survey by Lee Surveying and Mapping Co., Inc. on January 29, 2004.

Description prepared by:

A handwritten signature in black ink that reads "William K. Bruce".

William K. Bruce  
Professional Surveyor 7437  
February 3, 2004



ORIGINAL STAMP IN GREEN

37110104

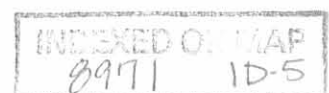



CURVE	DELTA ANGLE	RADIUS	ARC	TANGENT	CHORD	CHORD BEARING
C 1	54°04'17"	35.00'	33.03'	17.86'	31.82'	S 67°07'52"E
C 2	75°19'30"	30.00'	39.44'	23.16'	36.66'	N 48°10'15"E
C 3	12°46'18"	45.00'	10.03'	5.04'	10.01'	N 16°53'42"E
C 4	90°00'01"	10.00'	15.71'	10.00'	14.14'	N 49°10'00"W

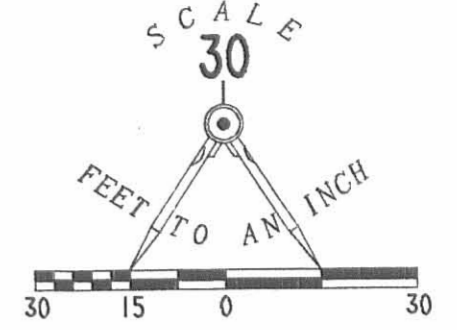

LOWE'S HOME CENTERS, INC.  
18.322  
O.R. 284, PG. 303

GUNNTOWN ROAD (60' WIDE)

0.602 ACRE  
OF WHICH 0.055 ACRE IS  
WITHIN THE RIGHT-OF-WAY

0.435 ACRE  
OF WHICH 0.117 ACRE IS  
WITHIN THE RIGHT-OF-WAY

0.370 ACRE

0.429 ACRE

DDR CONTINENTAL LP  
8.403 ACRES  
O.R. 358, PG. 183  
(PARCEL 1, TRACT 1)

CITY OF BELLEFONTAINE  
10' WIDE HIGHWAY  
R/W EASEMENT  
O.R. 284, PG. 301

CITY OF BELLEFONTAINE  
0.190 ACRE  
O.R. 291, PG. 557

SOUTH MAIN STREET (80')

- LEGEND
- 5/8 INCH IRON ROD SET
  - 5/8 INCH IRON ROD FOUND
  - ⊙ MAG NAIL SET
  - ⊗ P.K. NAIL FOUND
  - ⊗ RAIL ROAD SPIKE FOUND

A SURVEY OF 4 TRACTS OUT OF THE  
MAIN BELLE LLC. 1.836 ACRE TRACT  
OFFICIAL RECORD 674, PAGE 845  
SECTION. 32, TOWN 4, RANGE 14,  
LIBERTY TOWNSHIP  
CITY OF BELLEFONTAINE  
LOGAN COUNTY, OHIO



SURVEYED BY:

*William K. Bruce*  
WILLIAM K. BRUCE  
PROFESSIONAL SURVEYOR 7437  
JANUARY 29, 2004

COPYRIGHT 2004 BY:  
LEE SURVEYING & MAPPING CO., INC.  
117 North Madriver Street  
BELLEFONTAINE, OHIO 45311  
(937) 593-7335

2 WORKING DAYS  
**BEFORE YOU DIG**  
CALL TOLL FREE **800-362-2764**  
OHIO UTILITIES PROTECTION SERVICE.

INDEXED ON MAP  
8997 IP

# Lee Surveying and Mapping Co., Inc.

Land Surveys • Topography • Subdivisions • Construction Layout

117 N. Madriver St.  
Bellefontaine OH 43311



Phone: (937) 593-7335  
Fax: (937) 593-7444

## GOSLEE 1.836 ACRES

Lying in Section 32, Town 4, Range 14, City of Bellefontaine, Liberty Township, Logan County, Ohio.

Being all of the William T. Goslee, Married 1.037 acre tract as deeded and described in Official Record 674, Page 821, and the William T. Goslee, Married 0.799 acre tract as deeded and described in Official Record 674, Page 819, of the Logan County Records of deeds and being more particularly described as follows:

Beginning at a railroad spike found at the intersection of the center-lines of Gunntown Road and South Main Street (width varies).

THENCE, with the center-line of South Main Street, S 4°-10'-00"E, a distance of 36.62 feet to a 5/8 inch iron rod found at the TRUE POINT OF BEGINNING.

THENCE, with the center-line of South Main Street, S 4°-10'-00"E, a distance of 185.54 feet to a P.K. nail found.

THENCE, S 85°-50'-00"W, a distance of 40.00 feet to a 5/8 inch iron rod found.

THENCE, with the west line of the City of Bellefontaine, Ohio, 0.19 acre tract (O.R. 291, Pg. 557), S 4°-10'-00"E, a distance of 183.18 feet to a 5/8 inch iron rod found.

THENCE, with the lines of the Continental Bell, LTD., 8.403 acre tract (O.R. 276, Pg. 579), the following 3 (three) courses:

S 85°-50'-00"W, a distance of 180.00 feet to a 5/8 inch iron rod found.

With a curve to the right having a central angle of 90°-00'-00", a radius of 10.00, an arc length of 15.71', a chord bearing N 49°-10'-00"W, a distance of 14.14 feet to a 5/8 inch iron rod found.

N 4°-10'-00"W, a distance of 341.44 feet to a 5/8 inch iron rod found.

THENCE, with the Lowe's Home Centers, Inc., 18.322 acre tract (O.R. 284, Pg. 303), the following 5 (five) courses:

With a curve to the left having a central angle of 12°-46'-20", a radius of 45.00', an arc length of 10.03', a chord bearing N 16°-53'-39"E, a distance of 10.01 feet to a 5/8 inch iron rod found.

# Lee Surveying and Mapping Co., Inc.

Land Surveys • Topography • Subdivisions • Construction Layout

117 N. Madriver St.  
Bellefontaine OH 43311



Phone: (937) 593-7335  
Fax: (937) 593-7444

With a curve to the right having a central angle of  $75^{\circ}-19'-31''$ , a radius of 30.00', an arc length of 39.44', a chord bearing  $N 48^{\circ}-10'-14''E$ , a distance of 36.66 feet to a 5/8 inch iron rod found.

$N 85^{\circ}-50'-00''E$ , a distance of 139.04 feet to a 5/8 inch iron rod found.

With a curve to the right having a central angle of  $54^{\circ}-04'-18''$ , a radius of 35.00', an arc length of 33.03', a chord bearing  $S 67^{\circ}-07'-51''E$ , a distance of 31.82 feet to a 5/8 inch iron rod found at the right-of-way of South Main Street.

$N 85^{\circ}-50'-00''E$ , a distance of 30.00 feet to the point of beginning.

Containing 1.836 acres, of which, 0.128 acre is within the highway right-of-way.

The basis for bearings is the center-line of US Route 68, being  $S 4^{\circ}-10'-00''E$ , and all other bearings are from angles and distances measured in a field survey by Lee Surveying and Mapping co., Inc. on August 13, 2003

Description prepared by:



ORIGINAL STAMP IN GREEN

  
Jeffrey I. Lee  
Professional Surveyor 6359  
August 13, 2003

L-435

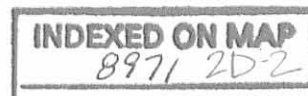



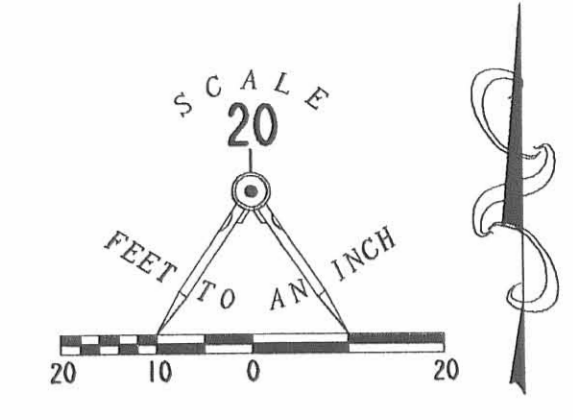

- LEGEND
- 5/8 INCH IRON ROD FOUND
  - ⊗ RAILROAD SPIKE FOUND
  - ⊙ P.K. NAIL FOUND

CURVE	DELTA ANGLE	RADIUS	ARC	TANGENT	CHORD	CHORD BEARING
C 1	90°00'00"	10.00'	15.71'	10.00'	14.14'	N 49°10'00"W
C 2	12°46'20"	45.00'	10.03'	5.04'	10.01'	N 16°53'39"E
C 3	75°19'31"	30.00'	39.44'	23.16'	36.66'	N 48°10'14"E
C 4	54°04'18"	35.00'	33.03'	17.86'	31.82'	S 67°07'51"E

BOUNDARY SURVEY OF  
 THE WILLIAM T. GOSLEE, MARRIED  
 1.037 ACRE TRACT  
 OFFICIAL RECORD 674, PAGE 821  
 AND THE WILLIAM T. GOSLEE, MARRIED  
 0.799 ACRE TRACT  
 OFFICIAL RECORD 674, PAGE 819  
 SECTION 32, TOWN 4, RANGE 14  
 CITY OF BELLEFONTAINE  
 LIBERTY TOWNSHIP  
 LOGAN COUNTY, OHIO



SURVEYED BY:  
  
 JEFFREY A. LEE  
 PROFESSIONAL SURVEYOR 6359  
 AUGUST 13, 2003

COPYRIGHT 1998 BY:  
 LEE SURVEYING & MAPPING CO., INC.  
 117 North Madriver Street  
 BELLEFONTAINE, OHIO 43311  
 (937) 593-7335



LOWE'S HOME CENTERS, INC.  
 18.322 ACRES  
 O.R. 284, PG. 303

EASEMENT  
 10' WIDE GAS AND TELEPHONE  
 EASEMENT

WILLIAM T. GOSLEE, MARRIED  
 1.037 ACRES  
 O.R. 674, PG. 821

1.836 ACRES  
 OF WHICH 0.128 ACRE IS WITHIN  
 THE HIGHWAY RIGHT-OF-WAY

WILLIAM T. GOSLEE, MARRIED  
 0.799 ACRE  
 O.R. 674, PG. 819

EASEMENT  
 10' WIDE SANITARY SEWER  
 EASEMENT

CITY OF BELLEFONTAINE, OHIO  
 10 ACRE TRACT  
 O.R. 281, PG. 557

2 WORKING DAYS  
**BEFORE YOU DIG**  
 CALL TOLL FREE 800-362-2764  
 OHIO UTILITIES PROTECTION SERVICE

INDEXED ON MAP  
 8971 2P

1. RECORD 1-2-96 8/11/10 (OK) JH



# Lee Surveying and Mapping Co.



Farm Surveys • Lot Surveys • Topography • Subdivisions • Construction Layout

143 EAST COLUMBUS AVENUE  
BELLEFONTAINE, OHIO 43311

(513) 593-7335

JEFFREY L. LEE, P.S.

## WILSON ANDERSON SLOPE EASEMENT 0.092 ACRE

Lying in Section 32, Town 4, Range 14, Liberty Township, Logan County, Ohio.

Being a permanent slope easement on the Wilson Anderson original 72.17 acre tract as deeded and described in Volume 390, Page 818 of the Logan County Records of Deeds and being more particularly described as follows:

Beginning at a railroad spike found at the intersection of the north line of Section 32 and the center-line of South Main Street (U.S. Route 68) in the City of Bellefontaine.

THENCE, with the center-line of South Main Street, S 4°-10'-00" E, a distance of 1282.61 feet to a PK nail set.

THENCE, with the north line of a 5.165 acre tract, part of the said 72.17 acre tract, and with a south line of the Venture Properties I, LLC, Ltd. original 9.392 acre tract (O.R. 259, Pg. 828), and a south corporation line of the City of Bellefontaine, S 85°-50'-00" W, a distance of 240.00 feet to the point of beginning.

THENCE, S 4°-10'-00" E, a distance of 20.00 feet to a point.

THENCE, S 85°-50'-00" W, a distance of 200.00 feet to a point.

THENCE, N 4°-10'-00" W, a distance of 20.00 feet to a point referenced by a 5/8 inch iron rod found at a corner of the aforementioned corporation line, S 85°-50'-00" W, a distance of 10.00 feet.

THENCE, with the said corporation line and a south line of the said 9.392 acre tract, N 85°-50'-00" E, a distance of 200.00 feet to the point of beginning.

Containing 0.092 acre.

The basis for bearings is based upon the center-line of South Main Street being S 4°-10'-00" E, and all other bearings are from angles and distances measured in field surveys by Lee Surveying and Mapping Company in December 1995.

Description prepared by:

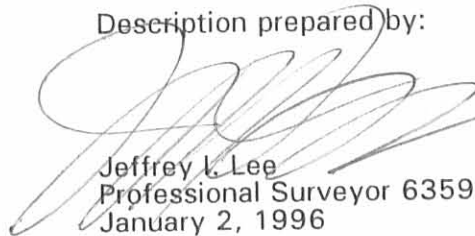
  
Jeffrey L. Lee  
Professional Surveyor 6359  
January 2, 1996



L 435

ORIGINAL STAMP IN GREEN

INDEXED ON MAP  
8971 3D

**REFERENCES**

LOGAN COUNTY ENGINEER'S SURVEY RECORDS, DRAWER R, FILE NUMBERS 1638, 777, 2621, 1384, 4314, 3737, AND 2907.

VENTURE PROPERTIES I, LLC LTD  
 1.037 ACRES  
 O.R. 259, PG. 825

**8.403 ACRES**

VENTURE PROPERTIES I, LLC, LTD  
 ORIG. 9.392 ACRES  
 O.R. 259, PG. 828

**SLOPE EASEMENT  
 0.092 ACRE**

WILSON ANDERSON  
 (5.165 ACRES)  
 PART OF THE ORIGINAL 72.17 AC.  
 VOL. 390, PG. 818

INDEXED ON MAP  
 8971 3P

WILSON ANDERSON  
 ORIG. 72.17 AC.  
 VOL. 390, PG. 818

**SOUTH MAIN STREET**

**0.190 ACRE**

**PERMANENT SLOPE EASEMENT  
 OUT OF THE WILSON ANDERSON  
 ORIGINAL 72.17 ACRE TRACT  
 VOLUME 390, PG. 818  
 SECTION 32, TOWN 4, RANGE 14  
 LIBERTY TOWNSHIP  
 LOGAN COUNTY, OHIO**

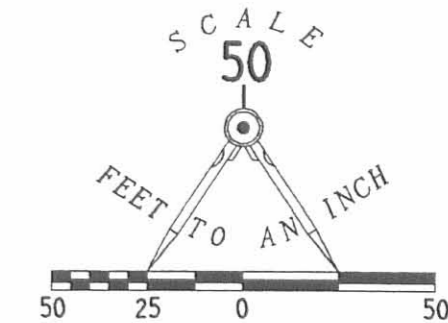

**LEGEND**

- 5/8" IRON ROD SET W/ PLASTIC I.D. CAP STAMPED "LEE PS6359"
- 5/8" IRON ROD FOUND
- 1" METAL PIPE FOUND
- ⊕ RAILROAD SPIKE SET
- ⊗ RAILROAD SPIKE FOUND
- ⊘ P.K. NAIL SET

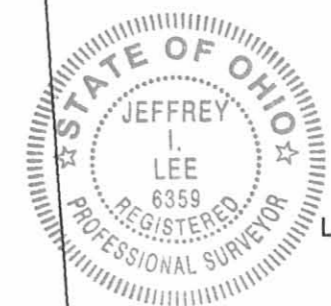

SURVEYED BY:  
  
 JEFFREY I. LEE  
 PROFESSIONAL SURVEYOR 6359  
 JANUARY 2, 1996

COPYRIGHT 1996 BY:  
**LEE SURVEYING & MAPPING CO., INC.**  
 143 East Columbus Avenue  
 BELLEFONTAINE, OHIO 43311  
 (513) 593-7335

ORIGINAL STAMP IN GREEN

REC'D 7-31-96 JML OK ✓



# Lee Surveying and Mapping Co., Inc.



Farm Surveys • Lot Surveys • Topography • Subdivisions • Construction Layout

117 North Madriver Street  
Bellefontaine, Ohio 43311

(513) 593-7335  
FAX (513) 593-7444

## EXHIBIT

### CONTINENTAL BELL. LTD. SANITARY SEWER EASEMENT 2

Lying in Section 32, Town 4, Range 14, City of Bellefontaine, Liberty Township, Logan County, Ohio.

Being a 10 feet wide sanitary sewer line easement through the Continental Bell, Ltd. original 8.403 acre tract as deeded and described in Official Record 276, Page 579 of the Logan County Records of Deeds and being more particularly described as follows:

Beginning at a 5/8 inch iron rod set at the southwest corner of the Continental Bell 0.799 acre tract (O.R. 276, Pg. 574) and on a north line of a 24.00 feet wide strip part of the said 8.403 acre tract.

THENCE, S 4°-10'-00" E, a distance of 1.44 feet to the north line of a 10 feet wide sanitary sewer easement.

THENCE, with the north line of the said sanitary sewer easement, S 85°-50'-00" W, a distance of 10.00 feet to a point.

THENCE, N 4°-10'-00" W, a distance of 11.43 feet to a 5/8 inch iron rod set.

THENCE, with a curve to the left having a central angle of 90°-00'-00", a radius of 10.00 feet, having a chord bearing S 49°-10'-00" E, a distance of 14.14 feet to the point of beginning.

The basis for bearings is the center-line of South Main Street being S 4°-10'-00" E, and all other bearings are from records of field surveys by Lee Surveying and Mapping Company in 1995.

Description prepared by:

Jeffrey I. Lee  
Professional Surveyor 6359  
July 19, 1996.  
Revised July 30, 1996



ORIGINAL STAMP IN GREEN

INDEXED ON MAP  
89714D-1



# Lee Surveying and Mapping Co., Inc.



Farm Surveys • Lot Surveys • Topography • Subdivisions • Construction Layout

117 North Madriver Street  
Bellefontaine, Ohio 43311

(513) 593-7335  
FAX (513) 593-7444

## EXHIBIT

### CONTINENTAL BELL. LTD. SANITARY SEWER EASEMENT 1

Lying in Section 32, Town 4, Range 14, City of Bellefontaine, Liberty Township, Logan County, Ohio.

Being a 10 feet wide sanitary sewer line easement through the Continental Bell, Ltd. 0.799 acre tract as deeded and described in Official Record 276, Page 574 of the Logan County Records of Deeds and being more particularly described as follows:

Beginning at a 5/8 inch iron rod set at the northwest corner of the said 0.799 acre tract and on the east line of the Continental Bell, Ltd original 8.403 acre tract (O.R. 276, Pg. 579).

THENCE, with the south line of the Venture Properties I, LLC 1.037 acre tract (O.R. 259, Pg. 825), N 85°-50'-00" E, a distance of 10.00 feet to a point.

THENCE, S 4°-10'-00" E, a distance of 183.18 feet to a 5/8 inch iron rod set.

THENCE, with the lines of the said 8.403 acre tract the following two courses:

With a curve to the right having a central angle of 90°-00'-00", a radius of 10.00 feet, having a chord bearing N 49°-10'-00" W, a distance of 14.14 feet to a 5/8 inch iron rod set.

N 4°-10'-00" W, a distance of 173.18 feet to the point of beginning.

The basis for bearings is the center-line of South Main Street being S 4°-10'-00" E, and all other bearings are from records of field surveys by Lee Surveying and Mapping Company in 1995.

Description prepared by:

Jeffrey I. Lee  
Professional Surveyor 6359  
July 19, 1996.  
Revised July 30, 1996

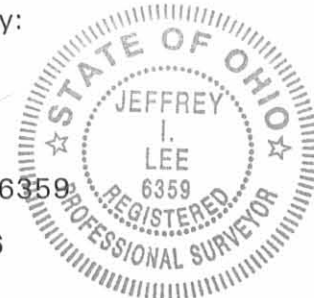

ORIGINAL STAMP IN GREEN

INDEXED ON MAP  
897140-2





# Lee Surveying and Mapping Co., Inc.



Farm Surveys • Lot Surveys • Topography • Subdivisions • Construction Layout

117 North Madriver Street  
Bellefontaine, Ohio 43311

(513) 593-7335  
FAX (513) 593-7444

## EXHIBIT D

### VENTURE PROPERTIES I, LLC NATURAL GAS AND BURIED TELEPHONE LINE EASEMENT

Lying in Section 32, Town 4, Range 14, City of Bellefontaine, Liberty Township, Logan County, Ohio.

Being a 10 feet wide natural gas and buried telephone line easement through the Venture Properties I, LLC 1.037 acre tract as deeded and described in Official Record 259, Page 825 of the Logan County Records of Deeds and being more particularly described as follows:

Beginning at a 5/8 inch iron rod set at the northeast corner of the said 1.037 acre tract and on the west right-of-way of South Main Street (60 feet wide).

THENCE, with the west right-of-way of South Main Street, S 4°-10'-00" E, a distance of 17.04 feet to a point.

THENCE, parallel with the north lines of the aforesaid 1.037 acre tract and 10 feet distant the following five courses:

N 40°-06'-00" W, a distance of 13.80 feet to a point.

With a curve to the left having a central angle of 54°-04'-18", a radius of 25.00 feet, having a chord bearing N 67°-07'-51" W, a distance of 22.73 feet to a point

S 85°-50'-00" W, a distance of 139.04 feet to a point.

With a curve to the left having a central angle of 75°-19'-31", a radius of 20.00 feet, having a chord bearing S 48°-10'-14" W, a distance of 24.44 feet to a point.

With a curve to the right having a central angle of 28°-45'-52", a radius of 55.00 feet, having a chord bearing S 24°-53'-27" W, a distance of 27.32 feet to a point.

THENCE, with the east line of the Continental Bell, Ltd. 8.403 acre tract (O.R. 276, Pg. 579), N 4°-10'-00" W, a distance of 17.08 feet to a 5/8 inch iron rod set.

THENCE, with the south lines of the Lowe's Home Centers, Inc. part of the 18.322 acre tract (O.R. 284, Pg. 303) the following four courses:

With a curve to the left having a central angle of 12°-46'-20", a radius of 45.00 feet, having a chord bearing N 16°-53'-39" E, a distance of 10.01 feet to a 5/8 inch iron rod set.

With a curve to the right having a central angle of 75°-19'-31", a radius of 30.00 feet, having a chord bearing N 48°-10'-14" E, a distance of 36.66 feet to a 5/8 inch iron rod set.

N 85°-50'-00" E, a distance of 139.04 feet to a 5/8 inch iron rod set.

With a curve to the right having a central angle of 54°-04'-18", a radius of 35.00 feet, having a chord bearing S 67°-07'-51" E, a distance of 31.82 feet to the point of beginning.

The basis for bearings is the center-line of South Main Street being S 4°-10'-00" E, and all other bearings are from records of field surveys by Lee Surveying and Mapping Company in 1995.

Description prepared by:

Jeffrey I. Lee  
Professional Surveyor 6359  
July 19, 1996.  
Revised July 30, 1996



ORIGINAL STAMP IN GREEN

INDEXED ON MAP  
8971 4D-3



LOWE'S HOME CENTERS, INC.  
18.322 ACRES  
O.R. 284, PG. 303

VENTURE PROPERTIES I, LLC  
1.037 ACRES  
O.R. 259, PG. 825

CONTINENTAL BELL, LTD.  
8.403 ACRES  
O.R. 276, PG. 579

CONTINENTAL BELL, LTD.  
0.799 ACRE  
O.R. 276, PG. 574

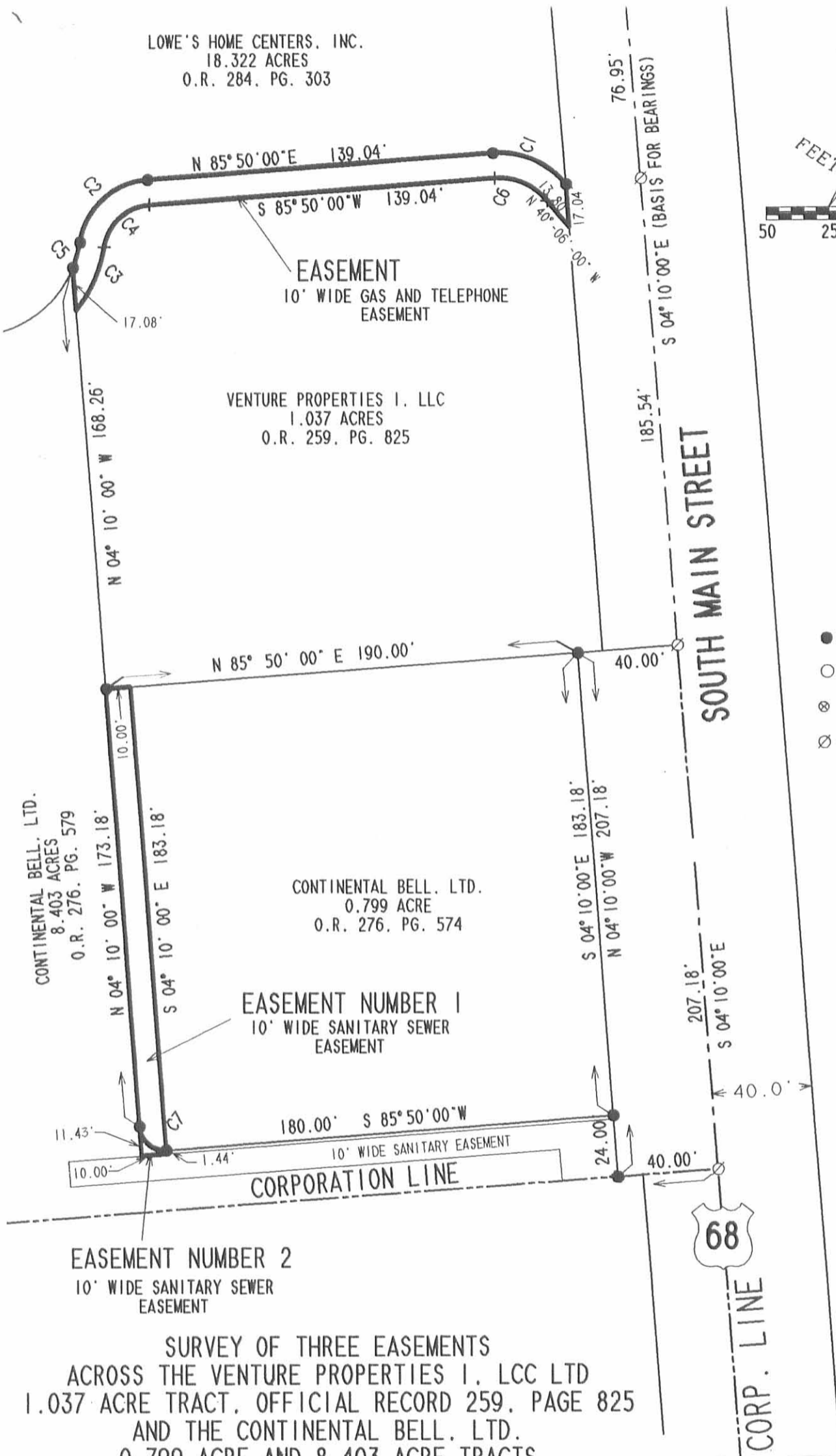
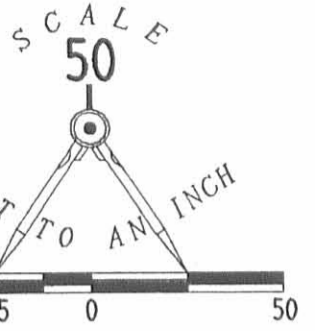

- 5/8" IRON ROD SET
- 5/8" IRON ROD FOUND
- ⊗ RAILROAD SPIKE FOUND
- ⊗ P.K. NAIL SET

CURVE	DELTA	RADIUS	LENGTH	CHORD	CHORD BEARING
C 1	54°04'18"	35.00'	33.03'	31.82'	S 67°07'51"E
C 2	75°19'31"	30.00'	39.44'	36.66'	N 48°10'14"E
C 3	28°45'52"	55.00'	27.61'	27.32'	S 24°53'27"W
C 4	75°19'31"	20.00'	26.29'	24.44'	S 48°10'14"W
C 5	12°46'20"	45.00'	10.03'	10.01'	N 16°53'39"E
C 6	54°04'18"	25.00'	23.59'	22.73'	N 67°07'51"W
C 7	90°00'00"	10.00'	15.71'	14.14'	N 49°10'00"W

**SURVEY OF THREE EASEMENTS  
ACROSS THE VENTURE PROPERTIES I, LCC LTD  
1.037 ACRE TRACT, OFFICIAL RECORD 259, PAGE 825  
AND THE CONTINENTAL BELL, LTD.  
0.799 ACRE AND 8.403 ACRE TRACTS  
OFFICIAL RECORD 276, PAGES 574 AND 579  
SECTION 32, TOWN 4, RANGE 14  
CITY OF BELLEFONTAINE  
LIBERTY TOWNSHIP  
LOGAN COUNTY, OHIO**



SURVEYED BY:  
**JEFFREY I. LEE**  
PROFESSIONAL SURVEYOR 6359  
JULY 18, 1996  
REVISED JULY 30, 1996

COPYRIGHT 1996 BY:  
**LEE SURVEYING & MAPPING CO., INC.**  
117 North Madriver Street  
BELLEFONTAINE, OHIO 43311  
(513) 593-7335

**EXHIBIT**

INDEXED ON MAP  
8971 4P ORIGINAL STAMP IN GREEN



# Lee Surveying and Mapping Co., Inc.



Farm Surveys • Lot Surveys • Topography • Subdivisions • Construction Layout

117 NORTH MADRIVER STREET  
BELLEFONTAINE, OHIO 43311

(937) 593-7335  
FAX (937) 593-7444

## EXHIBIT

### CONTINENTAL BELL. LTD. 15 FEET WIDE WATER LINE EASEMENT

Lying in Section 32, Town 4, Range 14, City of Bellefontaine, Liberty Township, Logan County, Ohio.

Being a 15 feet wide water line easement through the Continental Bell, Ltd. 0.799 acre tract as deeded and described in Official Record 276, Page 574 of the Logan County Records of Deeds and being more particularly described as follows:

Beginning at a 5/8 inch iron rod set at the southeast corner of the said 0.799 acre tract and on the west right-of-way line of South Main Street, U.S. Route 68 (80 feet wide).

THENCE, with the lines of the Continental Bell, Ltd 8.403 acre tract (O.R. 276, Pg. 579) the following three courses:

S 85°-50'-00" W, a distance of 180.00 feet to a 5/8 inch iron rod set.

With a curve to the right having a central angle of 90°-00'-00", a radius of 10.00 feet, having a chord bearing N 49°-10'-00" W, a distance of 14.14 feet to a 5/8 inch iron rod set.

N 4°-10'-00" W, a distance of 5.00 feet to a point.

THENCE, N 85°-50'-00" E, a distance of 190.00 feet to a point.

THENCE, S 4°-10'-00" E, a distance of 15.00 feet to the point of beginning.

The basis for bearings is the center-line of South Main Street being S 4°-10'-00" E, and all other bearings are from records of field surveys by Lee Surveying and Mapping Company in 1995.

Description prepared by:

  
Jeffrey I. Lee  
Professional Surveyor 6359  
November 1, 1996



ORIGINAL STAMP IN GREEN

INDEXED ON MAP  
8971 5D

LOWE'S HOME CENTERS, INC.  
18.322 ACRES  
O.R. 284, PG. 303

VENTURE PROPERTIES I, LLC  
1.037 ACRES  
O.R. 259, PG. 825

CONTINENTAL BELL, LTD.  
8.403 ACRES  
O.R. 276, PG. 579

CONTINENTAL BELL, LTD.  
0.799 ACRE  
O.R. 276, PG. 574

15 FEET WIDE WATER LINE EASEMENT  
THROUGH THE CONTINENTAL BELL, LTD.  
0.799 ACRE TRACT  
OFFICIAL RECORD 276, PAGES 574  
SECTION 32, TOWN 4, RANGE 14  
CITY OF BELLEFONTAINE  
LIBERTY TOWNSHIP  
LOGAN COUNTY, OHIO

INDEXED ON MAP  
8971 5P

EXHIBIT



ORIGINAL STAMP IN GREEN

PREPARED BY:

JEFFREY I. LEE  
PROFESSIONAL SURVEYOR 6359  
NOVEMBER 1, 1996

COPYRIGHT 1996 BY:  
LEE SURVEYING & MAPPING CO., INC.  
117 North Madriver Street  
BELLEFONTAINE, OHIO 43311  
(513) 593-7335

D 285 PLASEAS2

L 435-4

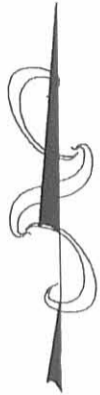
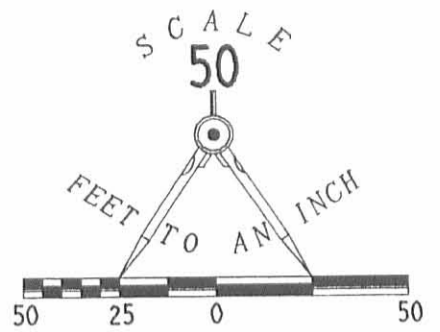

- 5/8" IRON ROD SET
- 5/8" IRON ROD FOUND
- ⊗ RAILROAD SPIKE FOUND
- ⊘ P.K. NAIL SET

CURVE	DELTA	RADIUS	LENGTH	CHORD	CHORD BEARING
C 1	54°04'18"	35.00'	33.03'	31.82'	S 67°07'51"E
C 2	75°19'31"	30.00'	39.44'	36.66'	N 48°10'14"E
C 3	28°45'52"	55.00'	27.61'	27.32'	S 24°53'27"W
C 4	75°19'31"	20.00'	26.29'	24.44'	S 48°10'14"W
C 5	12°46'20"	45.00'	10.03'	10.01'	N 16°53'39"E
C 6	54°04'18"	25.00'	23.59'	22.73'	N 67°07'51"W
C 7	90°00'00"	10.00'	15.71'	14.14'	N 49°10'00"W

