

STALEY
173.950 ACRES

Lying in Section 11, Town 3, Range 14, Harrison Township Logan County, Ohio.

Being all of the Donald J. Staley and Bonnie L. Staley 166.92 acre tract as deeded and described in Official Record 211, Page 679, and the Carol E. Shroyer 7.03 acre tract as deeded and described in Volume 391, Page 795 both of the Logan County Records of Deeds and being more particularly described for annexation purposes as follows:

Beginning at a point at the northeast corner of Section 11 and on the center-line of County Highway 32 (60 feet wide).

THENCE, with the east lines of Section 11, the said 166.92 acre tract, the said 7.03 acre tract, and the center-line of County Highway 32, S 5°-00'-00" W, a distance of 2994.60 feet to a point.

THENCE, with a northerly line of The City of Bellefontaine 148.753 acre tract (O.R. 323, Pg. 246, Exhibit A), N 77°-06'-55" W, a distance of 1380.00 feet to a point.

THENCE, with the easterly lines of the said 148.753 acre, and the Virginia Brock original 160.00 acre tract (O.R. 103, Pg. 798, Tract 1), N 1°-11'-53" E, a distance of 136.40 feet to a point on the quarter section line.

THENCE, with the quarter section line, the northerly line of said 160.00 acre tract and the southerly line of the said 166.92 acre tract, N 84°-18'-00" W, a distance of 1047.90 feet to a point.

THENCE, with the northeasterly line of the Crown Credit Company LTD., an Ohio Limited Liability Company 0.16 acre tract (O.R. 315, Pg. 115, Parcel 11, Tract 11), N 64°-35'-00" W, a distance of 335.00 feet to a point.

THENCE, with the west line of the northeast quarter of Section 11 and the east lines of the Crown Credit Company LTD., an Ohio Limited Liability Company 22.07 acre tract (O.R. 315, Pg. 115, Parcel 11, Tract 11), and the said 148.753 acre tract, N 5°-42'-00" E, a distance of 2555.00 feet to a point at the northwest corner of the northeast quarter of Section 11.

THENCE, with the north line of Section 11, and the southerly line of the Frederick J. Meredith original 164.00 acre tract (Vol. 331, Pg. 892, Second Tract), S 84°-42'-00" E, a distance of 2707.00 feet to the point of beginning.

Containing 173.950 acres of which 2.062 acres are in the highway right-of-way.

Bearings are based upon the center-line of County Highway 32. Being S 05°-00'-00" W, and all other bearings are from angles and distances from deed records.

LOGAN COUNTY COMMISSIONERS	<i>John Baucus</i>	12-28-99
	DATE	
	<i>Donald R. Cole</i>	12-28-99
	DATE	
	<i>George W. Clayton</i>	12-28-99
	DATE	
LOGAN COUNTY ENGINEER	<i>James King</i>	6-25-01
	DATE	
CHAIRMAN, TOWNSHIP TRUSTEES	<i>Donald R. Cole</i>	6-21-01
	DATE	
L.U.C. PLANNING DIRECTOR	<i>Gregg A. Jones</i>	6-21-01
	DATE	
MAYOR OF BELLEFONTAINE	<i>Robert C. Smith</i>	6-20-01
	DATE	
PRESIDENT, CITY COUNCIL	<i>William R. Patterson</i>	7-11-00
	DATE	
CLERK, CITY COUNCIL	<i>Vicki Yeakam</i>	11-20-01
	DATE	
PLAT PRE-APPROVED	<i>James M. Yeakam</i>	9-28-99
	DATE	
PLAT CHECKED	<i>Jon C. Davis</i>	8-12-02
	DATE	
CITY ORDINANCE NUMBER	00-54, 7-11-2000	

TRANSFERRED THIS 13th DAY OF September, 19 2002

AUDITOR, LOGAN COUNTY, OHIO *Michael E. Godwin*

RECEIVED FOR RECORD AT 11:31:58 O'CLOCK A.M.

THIS 13 DAY OF September, 19 2002

RECORDER, LOGAN COUNTY, OHIO *Linda Hanson*

RECORDED IN PLAT CABINET B, SLIDE 78A

CITY OF BELLEFONTAINE
ANNEXATION MAP OF
173.950 ACRES
SECTION 11, TOWN 3, RANGE 14
HARRISON TOWNSHIP
LOGAN COUNTY, OHIO

SURVEYOR'S AFFIDAVIT

THE ABOVE ANNEXATION MAP HAS BEEN PREPARED FROM RECORDS BY LEE SURVEYING AND MAPPING COMPANY. THIS IS NOT A BOUNDARY SURVEY AS DEFINED IN 4733-37 OF THE OHIO ADMINISTRATIVE CODE.

JEFFREY L. LEE
PROFESSIONAL SURVEYOR 6359
SEPTEMBER 8, 1999

STATE OF OHIO
JEFFREY L. LEE
6359
PROFESSIONAL SURVEYOR

ORIGINAL STAMP IN GREEN

002009922



Received 7/1/08 GREGA

Lee Surveying and Mapping Co., Inc.

Land Surveys • Topography • Subdivisions • Construction Layout

117 N. Madriver St.
Bellefontaine OH 43311



Phone: (937) 593-7335
Fax: (937) 593-7444

LINK 5.943 ACRES

Lying in Section 11, Town 3, Range 14, City of Bellefontaine, Harrison Township, Logan County, Ohio.

Being out of the Dave A. Link and Michelle D. Link 167.874 acre tract as deeded and described in Official Record 755, Page 535 of the Logan County Records of Deeds and being more particularly described as follows:

Commencing on a railroad spike found at the northeast corner of Section 11 on the center-line of County Highway 32.

THENCE, with the east line of Section 11 and the center-line of County Highway 32 (60 feet wide), S 3°-54'-32"W, a distance of 1084.99 feet to a MAG nail set at the TRUE POINT OF BEGINNING.

THENCE, with the east line of Section 11 and the center-line of County Highway 32, S 3°-54'-32"W, a distance of 150.00 feet to a MAG nail set.

THENCE, within the right-of-way of County Highway 32, N 86°-05'-28"W, a distance of 30.00 feet to a 5/8 inch iron rod set on the west right-of-way of County Highway 32.

THENCE, with the west right-of-way of County Highway 32, N 3°-54'-32"E, a distance of 45.00 feet to a 5/8 inch iron rod set.

THENCE, N 86°-05'-32"W, a distance of 306.29 feet to a 5/8 inch iron rod set.

THENCE, with a curve to the right, having a central angle of 26°-33'-54", a radius of 330.00 feet, an arc length of 153.00 feet, a chord bearing N 72°-48'-35"W, a distance of 151.64 feet to a 5/8 inch iron rod set.

THENCE, N 59°-31'-38"W, a distance of 305.57 feet to a 5/8 inch iron rod set.

THENCE, with a curve to the left, having a central angle of 26°-33'-54", a radius of 270.00 feet, an arc length of 125.18 feet, a chord bearing N 72°-48'-35"W, a distance of 124.07 feet to a 5/8 inch iron rod set.

THENCE, N 86°-05'-32"W, a distance of 402.10 feet to a 5/8 inch iron rod set.

THENCE, N 3°-54'-28"E, a distance of 385.00 feet to a 5/8 inch iron rod set, passing a 5/8 inch iron rod set at 60.00 feet.

THENCE, S 86°-05'-32"E, a distance of 540.00 feet to a 5/8 inch iron rod set.



Lee Surveying and Mapping Co., Inc.

Land Surveys • Topography • Subdivisions • Construction Layout

117 N. Madriver St.
Bellefontaine OH 43311

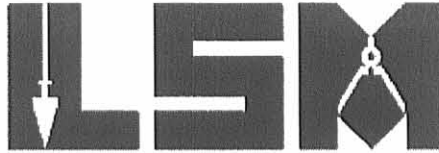

Phone: (937) 593-7335
Fax: (937) 593-7444

THENCE, S 3°-54'-28"W, a distance of 355.20 feet to a 5/8 inch iron rod set.

THENCE, with a curve to the right, having a central angle of 1°-51'-50", a radius of 330.00 feet, an arc length of 10.73, a chord bearing S 60°-27'-33"E, a distance of 10.73 feet to a 5/8 inch iron rod set.

THENCE, S 59°-31'-38"E, a distance of 305.57 feet to a 5/8 inch iron rod set.

THENCE, with a curve to the left, having a central angle of 26°-33'-54", a radius of 270.00 feet, an arc length of 125.18 feet, a chord bearing S 72°-48'-35"E, a distance of 124.07 feet to a 5/8 inch iron rod set.

THENCE, S 86°-05'-32"E, a distance of 306.29 feet to a 5/8 inch iron rod set on the west right-of-way of County Highway 32.

THENCE, with the west right-of-way of County Highway 32, N 3°-54'-32"E, a distance of 45.00 feet to a 5/8 inch iron rod set.

THENCE, within the right-of-way of County Highway 32, S 86°-05'-28"E, a distance of 30.00 feet to the point of beginning.

Containing 5.943 acres, of which 0.103 acre is within the highway right-of-way.

The basis for bearings is the east line of Section 11, being S 3°-54'-32"W, and all other bearings are from angles and distances measured in a field survey by Lee Surveying and Mapping Co., Inc. on May 29, 2008.

Description prepared by:



ORIGINAL STAMP IN GREEN

William K. Bruce

William K. Bruce
Professional Surveyor 7437
May 29, 2008
Revised June 30, 2008

4644058a



Revised 7/1/08 OK gmn

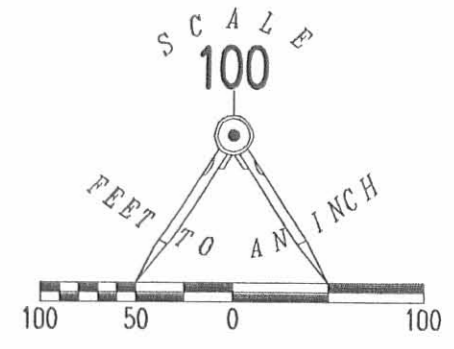

CURVE	DELTA ANGLE	RADIUS	ARC LENGTH	CHORD BEARING	CHORD LENGTH
C1	26°33'54"	330.00'	153.00'	N 72°48'35" W	151.64'
C2	26°33'54"	270.00'	125.18'	N 72°48'35" W	124.07'
C3	01°51'50"	330.00'	10.73'	S 60°27'33" E	10.73'
C4	26°33'54"	270.00'	125.18'	S 72°48'35" E	124.07'

DAVE A. LINK AND
MICHELLE D. LINK
167.874 ACRES
O.R. 755, PG. 535

DAVE A. LINK AND
MICHELLE D. LINK
167.874 ACRES
O.R. 755, PG. 535

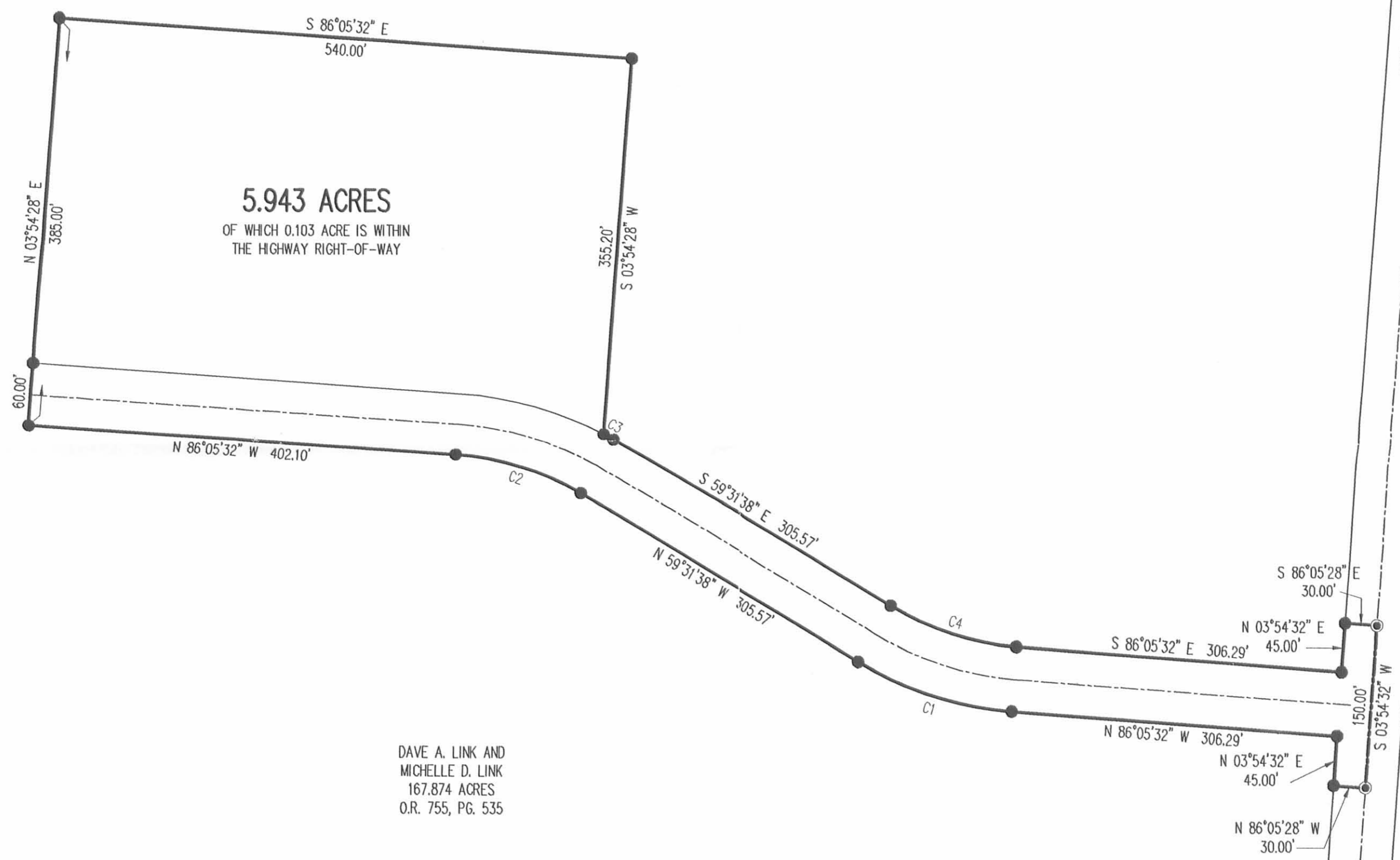

5.943 ACRES
OF WHICH 0.103 ACRE IS WITHIN
THE HIGHWAY RIGHT-OF-WAY

DAVE A. LINK AND
MICHELLE D. LINK
167.874 ACRES
O.R. 755, PG. 535

12 6
11 5

1084.99'
S 03°54'32" W
(BASIS FOR BEARINGS)
COUNTY HIGHWAY 32 (60')

- LEGEND:
- ⊗ RAILROAD SPIKE FOUND
 - ⊙ MAG NAIL SET
 - 5/8 INCH IRON ROD SET

**SURVEY OF 5.943 ACRES OUT OF THE
DAVE A. LINK AND
MICHELLE D. LINK
167.874 ACRE TRACT
OFFICIAL RECORD 755, PAGE 535
SECTION 11, TOWN 3, RANGE 14
CITY OF BELLEFONTAINE
HARRISON TOWNSHIP
LOGAN COUNTY, OHIO**

SURVEYED BY:
William K. Bruce
WILLIAM K. BRUCE
PROFESSIONAL SURVEYOR 7437
MAY 29, 2008
REVISED JUNE 30, 2008



COPYRIGHT 2008 BY:
LEE SURVEYING & MAPPING CO., INC.
117 North Modriver Street
BELLEFONTAINE, OHIO 43311
(937) 593-7335
surveys@lsmc.us

ORIGINAL STAMP IN GREEN

KSS D0508 4644058A L-4644-2

2 WORKING DAYS
BEFORE YOU DIG
CALL TOLL FREE **800-362-2764**
OHIO UTILITIES PROTECTION SERVICE

INDEXED ON MAP
9272 1P

Received 11/24/99 OK JCH

Lee Surveying and Mapping Co., Inc.

Land Surveys • Topography • Subdivisions • Construction Layout

117 N. Madriver St.
Bellefontaine OH 43311



Phone: (937) 593-7335
Fax: (937) 593-7444

STALEY 167.874 ACRES

Lying in Section 11, Town 3, Range 14, ^{CITY OF BELLEFONTAINE,} Harrison Township, Logan County, Ohio.

Being all of the Donald J. Staley and Bonnie L. Staley 166.92 acre tract as deeded and described in Official Record 211, Page 679 of the Logan County Records of Deeds and being more particularly described as follows:

Beginning at a railroad spike found at the northeast corner of Section 11 and the center-line of County Highway 32.

THENCE, with the east line of Section 11 and the center-line of County Highway 32, (60 feet wide), S 3°-54'-32" W, a distance of 2700.16 feet to a stone found in monument box on the southeast corner of the northeast quarter of Section 11.

THENCE, with the south line of the northeast quarter of Section 11 and the north lines of the Carol E. Shroyer 7.03 acre tract, (Vol. 391, Pg. 795) and the Virginia Brock original 160.00 acre tract, (O.R. 103, Pg. 798, Tract I), N 85°-39'-17" W, a distance of 2229.34 feet to a 5/8 inch iron rod found, passing a 5/8 inch iron rod set at 30.00 feet and at 1376.26 feet.

THENCE, with the north line of the City of Bellefontaine 148.753 acre tract, (O.R. 323, Pg. 246, Exhibit A), N 85°-30'-41" W, a distance of 157.77 feet to a 5/8 inch iron rod found.

THENCE, with the northerly line of the Crown Credit Company Ltd. 0.16 acre tract, (O.R. 315, Pg. 115, Parcel II, Tract II), N 65°-05'-06" W, a distance of 376.30 feet to a 5/8 inch iron rod found.

THENCE, with the west line of the northeast quarter of Section 11, the City of Bellefontaine Corporation Line, and the east lines of the Crown Credit Company Ltd, 22.07 acre tract, (O.R. 315, Pg. 115, Parcel II, Tract I) and the said 148.753 acre tract, N 4°-36'-06" E, a distance of 2554.11 feet to a 5/8 inch iron rod found.

THENCE, with the north line of Section 11, and the south line of the Frederick J. Meredith original 164.00 acre tract, (Vol. 331, Pg. 892, Second Tract), S 85°-56'-16" E, a distance of 2707.47 feet to the point of beginning, passing a 5/8 inch iron rod set at 2677.47 feet.

Containing 167.874 acres, of which 1.860 acres are within the highway right-of-way.

The basis for bearings is the north line of the said 148.753 acre tract, being N 78°-11'-50" W, and all other bearings are from angles and distances measured in a field survey by Lee Surveying and Mapping Co., Inc. on November 17, 1999.

Description prepared by:

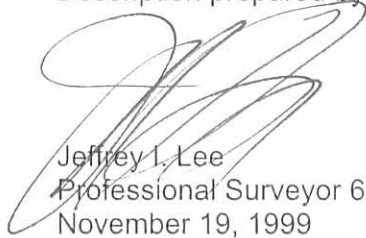

ORIGINAL STAMP IN GREEN

Jeffrey I. Lee
Professional Surveyor 6359
November 19, 1999

L-2801

INDEXED ON MAP
9272 2D-1

Received 11/24/99 OK GLH

Lee Surveying and Mapping Co., Inc.

Land Surveys • Topography • Subdivisions • Construction Layout

117 N. Madriver St.
Bellefontaine OH 43311



Phone: (937) 593-7335
Fax: (937) 593-7444

SHROYER 6.915 ACRES

Lying in Section 11, Town 3, Range 14, Harrison Township, Logan County, Ohio.

Being all of the Carol E. Shroyer 7.03 acre tract as deeded and described in Volume 391, Page 795 of the Logan County Records of Deeds and being more particularly described as follows:

Beginning at a stone found in monument box on the southeast corner of the northeast quarter of Section 11 on the center-line of County Highway 32

THENCE, with the east line of Section 11, and the center-line of County Highway 32 (60 feet wide), S 5°-35'-20" W, a distance of 308.80 feet to a MAG nail set.

THENCE, with the north line of the City of Bellefontaine 148.753 acre tract, (O.R. 323, Pg. 246, Exhibit A), N 78°-11'-50" W, a distance of 1383.24 feet to a 5/8 inch iron rod found, passing a 5/8 inch iron rod found at 30.00 feet.

THENCE, with a east line of the said 148.753 acre tract and the Virginia Brock original 160.00 acre tract, (O.R. 103, Pg. 798, Tract I), N 5°-13'-25" E, a distance of 129.22 feet to a 5/8 inch iron rod set.

THENCE, with the south line of the northeast quarter of Section 11 and the south line of the Donald J. Staley 166.92 acre tract, (O.R. 211, Pg. 679) S 85°-39'-17" E, a distance of 1376.26 feet to the point of beginning, passing a 5/8 inch iron rod set at 1346.26 feet.

Containing 6.915 acres, of which 0.211 acre is within the highway right-of-way.

The basis for bearings is the north line of the said 148.753 acre tract, being N 78°-11'-50" W, and all other bearings are from angles and distances measured in a field survey by Lee Surveying and Mapping Co., Inc. on November 17, 1999.

Description prepared by:

Jeffrey I. Lee
Professional Surveyor 6359
November 19, 1999



L-2801

9272 2D-2

FREDERICK J. MEREDITH &
EMERY L. MEREDITH
ORIG. 164.00 ACRES
VOL. 331, PG. 892
SECOND TRACT

KEMP G. CARTER III &
LORI K. CARTER
ORIG. 5.55 ACRES
VOL. 378, PG. 329

CHARLES MICHAEL BIBLE &
LISSA D. BIBLE
2.629 ACRES
O.R. 260, PG. 934

JOHN F. HOLLOPETER &
TONI D. HOLLOPETER
ORIG. 26.69 ACRES
VOL. 407, PG. 100

JAMES E. ALIG
0.990 ACRE
O.R. 46, PG. 763

DAVID L. WHITE &
PEGGY WHITE
1.00 ACRE
VOL. 332, PG. 783

ROBERT T. DEAL &
LINDA K. DEAL
1.00 ACRE
O.R. 398, PG. 325

DOROTHY M. VAN BUSKIRK
1.00 ACRE
O.R. 43, PG. 628

WILMA F. BUROKER
ORIG. 77.14 ACRES
O.R. 60, PG. 623

WILLIAM E. MOLTON &
MARILYN L. MOLTON
1.00 ACRE
VOL. 346, PG. 116

THADDEUS E. DABROWSKI
1.02 ACRES
VOL. 401, PG. 411
TRACT I

VANCE H. BICKHAM &
ELIZABETH A. BICKHAM
TRUSTEES OF THE
BICKHAM LIVING TRUST
1.00 ACRE
O.R. 405, PG. 298

WILLIAM M. HOON &
MICHELLE R. HOON
1.25 ACRES
O.R. 419, PG. 233

RICHARD P. MAIER &
RITA F. MAIER
1.00 ACRE
VOL. 312, PG. 552

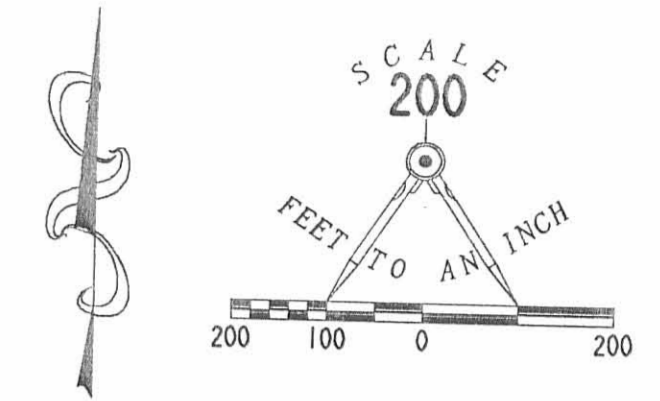

LEGEND

- 5/8 INCH IRON ROD SET
- 5/8 INCH IRON ROD FOUND
- ⊙ MAG NAIL SET
- ⊗ RAILROAD SPIKE FOUND
- ☒ STONE FOUND IN MONUMENT BOX

THE CITY OF BELLEFONTAINE
148.753 ACRES
O.R. 323, PG. 246
EXHIBIT A

CITY OF BELLEFONTAINE CORPORATION LINE

CROWN CREDIT COMPANY LTD.,
AN OHIO LIMITED LIABILITY COMPANY
22.07 ACRES
O.R. 315, PG. 115
PARCEL II, TRACT I

167.874 ACRES
OF WHICH 1.860 ACRES ARE WITHIN THE
HIGHWAY RIGHT-OF-WAY

DONALD J. STALEY &
BONNIE L. STALEY
166.92 ACRES
O.R. 211, PG. 679

RETRACEMENT SURVEY OF THE
DONALD J. STALEY AND BONNIE L. STALEY
166.92 ACRE TRACT
OFFICIAL RECORD 211, PAGE 679
AND THE CAROL E. SHROYER
7.03 ACRE TRACT
VOLUME 391, PAGE 795
SECTION 11, TOWN 3, RANGE 14
HARRISON TOWNSHIP
LOGAN COUNTY, OHIO

CROWN CREDIT COMPANY LTD.,
AN OHIO LIMITED LIABILITY COMPANY
0.16 ACRES
O.R. 315, PG. 115
PARCEL III, TRACT II

THE CITY OF BELLEFONTAINE
148.753 ACRES
O.R. 323, PG. 246, EXHIBIT A

6.915 ACRES
OF WHICH 0.211 ACRES ARE WITHIN THE
HIGHWAY RIGHT-OF-WAY

CAROL E. SHROYER
7.03 ACRES
VOL. 391, PG. 795

VIRGINIA BROCK &
CHARLES E. GEBBY
ORIG. 160.00
O.R. 103, PG. 798
TRACT I

CITY OF BELLEFONTAINE CORPORATION LINE

COUNTY HIGHWAY 32 (60')

2 WORKING DAYS
BEFORE YOU DIG
CALL TOLL FREE 800-362-2764
OHIO UTILITIES PROTECTION SERVICE.



SURVEYED BY:
Jeffrey L. Lee
JEFFREY L. LEE
PROFESSIONAL SURVEYOR 6359
November 17, 1999.

COPYRIGHT 1999 BY:
LEE SURVEYING & MAPPING CO., INC.
117 North Madison Street
BELLEFONTAINE, OHIO 43311
(937) 693-7335

D-354 STALEY L-2801-1

9272 29

11-17-14

Lee Surveying and Mapping Co., Inc.



APPROVED

Land Surveys • Topography • Subdivisions • Construction Layout

117 N. Madriver St.
Bellefontaine OH 43311



Phone: (937) 593-7335
Fax: (937) 593-7444
surveys@lsminc.us

LINK 8.324 ACRES

Lying in Section 11, Town 3, Range 14, City of Bellefontaine, Harrison Township, Logan County, Ohio.

Being out of the Dave A. Link and the Michelle D. Link 167.874 acre tract as deeded and described in Official Record 755, Page 535 of the Logan County Records of Deeds and being more particularly described as follows:

Commencing at a railroad spike found at the northeast corner of Section 11, on the center-line of County Highway 32 (60 feet wide).

THENCE, with the north line of Section 11, N 85°-56'-16"W, a distance of 410.06 feet to a 5/8 inch iron rod set at the TRUE POINT OF BEGINNING.

THENCE, S 03°-54'-28"W, a distance of 1120.83 feet to a 5/8 inch iron rod set.

THENCE, with the north right-of-way of Foundation Drive (60 feet wide) the following three courses:

With a curve to the right, having a central angle of 10°-42'-57", a radius of 270.00 feet, an arc length of 50.50 feet, a chord bearing N 64°-53'-07"W, a distance of 50.42 feet to a 5/8 inch iron rod found.

N 59°-31'-38"W, a distance of 305.57 feet to a 5/8 inch iron rod found.

With a curve to the left, having a central angle of 01°-51'-50", a radius of 330.00 feet, an arc length of 10.73 feet, a chord bearing N 60°-27'-33"W, a distance of 10.73 feet to a 5/8 inch iron rod set.

THENCE, with the lines of the LCG Commerce, LLC, 5.943 acre tract (O.R. 930, Pg. 927), the following two courses:

N 03°-54'-28"E, a distance of 355.20 feet to a 5/8 inch iron rod set.

N 86°-05'-32"W, a distance of 30.00 feet to a 5/8 inch iron rod set.

INDEXED ON MAP
9272-3D-1

Lee Surveying and Mapping Co., Inc.

Land Surveys • Topography • Subdivisions • Construction Layout

117 N. Madriver St.
Bellefontaine OH 43311

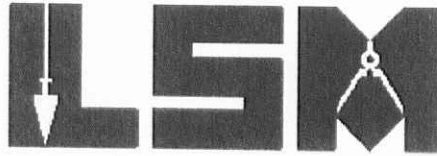

Phone: (937) 593-7335
Fax: (937) 593-7444
surveys@lsminc.us

THENCE, N 03°-54'-28"E, a distance of 607.06 feet to a 5/8 inch iron rod set on the north line of Section 11.

THENCE, with the north line of Section 11 and the south line of the Buckangehelas, LLC 137.165 acre tract (O.R. 997, Pg. 771), S 85°-56'-16"E, a distance of 360.00 feet to the point of beginning.

Containing 8.324 acres.

Property is subject to any and all previous easements and rights-of-way of record.

The basis for bearings is the north line of Section 11, being S 85°-56'-16"E, and all other bearings are from angles and distances measured in a field survey by Lee Surveying and Mapping Co., Inc. on October 31, 2016.

Description prepared by:

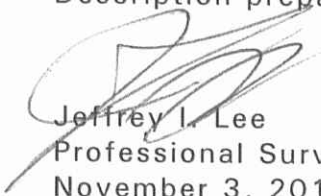

ORIGINAL STAMP IN GREEN

Jeffrey I. Lee
Professional Surveyor 6359
November 3, 2016

L-46441016

INDEXED ON MAP

9272 3D-2

11-17-16

Lee Surveying and Mapping Co., Inc.

Land Surveys • Topography • Subdivisions • Construction Layout



117 N. Madriver St.
Bellefontaine OH 43311



Phone: (937) 593-7335
Fax: (937) 593-7444
surveys@lsminc.us

LCG COMMERCE, LLC 0.240 ACRE

Lying in Section 11, Town 3, Range 14, City of Bellefontaine, Harrison Township, Logan County, Ohio.

Being out of the LCG Commerce, LLC, 5.943 acre tract as deeded and described in Official Record 930, Page 927 of the Logan County Records of Deeds and being more particularly described as follows:

Commencing at a railroad spike found at the northeast corner of Section 11, on the center-line of County Highway 32 (60 feet wide).

THENCE, with the north line of Section 11, N 85°-56'-16"W, a distance of 770.06 feet to a 5/8 inch iron rod set, passing a 5/8 inch iron rod set at 410.06 feet.

THENCE, S 03°-54'-28"W, a distance of 607.06 feet to a 5/8 inch iron rod set at the TRUE POINT OF BEGINNING.

THENCE, with the lines of the Dave A. Link and Michelle D. Link, 167.874 acre tract (O.R. 755, Pg. 535), the following two courses:

S 86°-05'-32"E, a distance of 30.00 feet to a 5/8 inch iron rod set.

S 03°-54'-28" W, a distance of 355.20 feet to a 5/8 inch iron rod set on the north right-of-way of Foundation Drive.

THENCE, with the north right-of-way of Foundation Drive (60 feet wide), with a curve to the left, having a central angle of 05°-36'-57", a radius of 330.00 feet, an arc length of 32.34 feet, a chord bearing N 64°-11'-56"W, a distance of 32.33 feet to a 5/8 inch iron rod set.

INDEXED ON MAP

9272 3D-3

Lee Surveying and Mapping Co., Inc.

Land Surveys • Topography • Subdivisions • Construction Layout

117 N. Madriver St.
Bellefontaine OH 43311

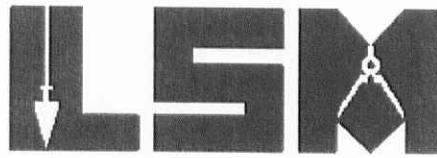

Phone: (937) 593-7335
Fax: (937) 593-7444
surveys@lsminc.us

THENCE, N 03°-54'-28"E, a distance of 343.14 feet to the point of beginning.

Containing 0.240 acre.

Property is subject to any and all previous easements and rights-of-way of record.

This parcel is to be attached to an adjoining tract of land and is not to be used as a separate and independent parcel.

The basis for bearings is the north line of Section 11, being S 85°-56'-16"E, and all other bearings are from angles and distances measured in a field survey by Lee Surveying and Mapping Co., Inc. on October 31, 2016.

Description prepared by:



ORIGINAL STAMP IN GREEN

Jeffrey I. Lee
Professional Surveyor 6359
November 3, 2016

L-46441016

INDEXED ON MAP

9272 3D 4

11-17-14

APPROVED

CURVE	DELTA ANGLE	RADIUS	ARC LENGTH	CHORD BEARING	CHORD LENGTH
C1	10°42'57"	270.00'	50.50'	N 64°53'07" W	50.42'
C2	01°51'50"	330.00'	10.73'	N 60°27'33" W	10.73'
C3	05°36'57"	330.00'	32.34'	N 64°11'56" W	32.33'

BUCKANGEHELAS, LLC
137.165 ACRE TRACT
O.R. 997, PG. 771

BASIS FOR BEARINGS
S 85°56'16" E
360.00'

N 85°56'16" W
410.06'

DAVE A. LINK AND
MICHELLE D. LINK
167.874 ACRES
O.R. 755, PG. 535

N 03°54'28" E
607.06'

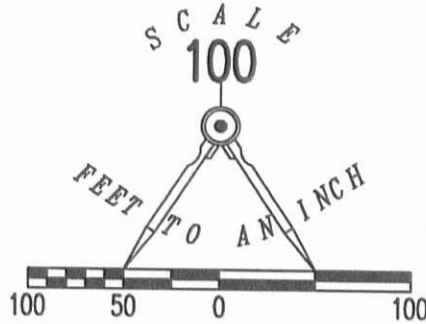

COUNTY HIGHWAY 32 (60')

8.324 ACRES

LEGEND

- 5/8 INCH IRON ROD SET WITH PLASTIC I.D. CAP STAMPED "LSM7437"
- 5/8 INCH IRON ROD FOUND
- ⊗ RAILROAD SPIKE FOUND

S 86°05'32" E
30.00'

0.240 ACRE

LOG COMMERCE, LLC
5.943 ACRES
O.R. 930, PG. 927

N 03°54'28" E
343.14'

S 03°54'28" W
355.20'

1120.83'
S 03°54'28" W

SURVEY OF 8.324 ACRES OUT OF THE
DAVE A. LINK AND MICHELLE D. LINK
167.874 ACRE TRACT
OFFICIAL RECORD 755, PAGE 535
AND 0.240 ACRE OUT OF THE
LCG COMMERCE, LLC
5.943 ACRE TRACT
OFFICIAL RECORD 930, PAGE 927
SECTION 11, TOWN 3, RANGE 14
CITY OF BELLEFONTAINE
HARRISON TOWNSHIP
LOGAN COUNTY, OHIO

FOUNDATION DRIVE (60')

N 59°31'38" W
305.57'

C1

NOTE:

THE 0.240 ACRE PARCEL IS TO BE ATTACHED TO AN ADJOINING TRACT OF LAND AND IS NOT TO BE USED AS A SEPARATE AND INDEPENDENT PARCEL.

THIS SURVEY WAS PREPARED IN THE ABSENCE OF A COMPLETE AND ACCURATE TITLE SEARCH AND DOES NOT GUARANTEE TITLE.

2 WORKING DAYS



BEFORE YOU DIG



CALL TOLL FREE 800-362-2764

OHIO UTILITIES PROTECTION SERVICE.



ORIGINAL STAMP IN GREEN

SURVEYED BY:

(Signature)
JEFFREY I. LEE
PROFESSIONAL SURVEYOR 6359
OCTOBER 31, 2016

COPYRIGHT 2016 BY:

LEE SURVEYING & MAPPING CO., INC.
117 North Madriver Street
BELLEFONTAINE, OHIO 43311
(937) 593-7335
WWW.LSMINC.US
surveys@lsminc.us

ADW/KSS D1016 46441016 L-4644-3

INDEXED ON MAP
9272 3P

Lee Surveying and Mapping Co., Inc.



Land Surveys • Topography • Subdivisions • Construction Layout



117 N. Madriver St.
Bellefontaine OH 43311

Phone: (937) 593-7335
Fax: (937) 593-7444
surveys@lsminc.us

LCG COMMERCE, LLC 3.820 ACRES

Lying in Section 11, Town 3, Range 14, City of Bellefontaine, Harrison Township, Logan County, Ohio.

Being out of the LCG Commerce, LLC, original 5.943 acre tract as deeded and described in Official Record 930, Page 927 of the Logan County Records of Deeds and being more particularly described as follows:

Commencing on a railroad spike found on the northeast corner of Section 11 on the center-line of County Highway 32.

THENCE, with the north line of Section 11, N 85°-56'-16"W, a distance of 770.06 feet to a 5/8 inch iron rod set.

THENCE, with the west line of the LCG Commerce, LLC, 8.324 acre tract, S 03°-54'-28"W, a distance of 607.06 feet to a 5/8 inch iron rod found.

THENCE, with the a south line of the remainder of the Dave A. Link and Michelle D. Link, original 167.874 acre tract (O.R. 755, Pg. 535), N 86°-05'-32"W, a distance of 30.00 feet to a 5/8 inch iron rod set at the TRUE POINT OF BEGINNING.

THENCE, S 03°-54'-28"W, a distance of 343.14 feet to a 5/8 inch iron rod set on the north right-of-way of Foundation Drive.

THENCE, with the north right-of-way of Foundation Drive (60 feet wide), the following two courses:

With a curve to the left, having a central angle of 19°-04'-07", a radius of 330.00 feet, an arc length of 109.92 feet, a chord bearing N 76°-32'-58"W, a chord length of 109.42 feet to a 5/8 inch iron rod set.

N 86°-05'-32"W, a distance of 402.10 feet to a 5/8 inch iron rod found.

THENCE, with the lines of the remainder of the aforesaid 167.874 acre tract, the following two courses:

N 03°-54'-28"E, a distance of 325.00 feet to a 5/8 inch iron rod set.

S 86°-05'-32"E, a distance of 510.00 feet to the point of beginning.

Containing 3.820 acres.

Property is subject to any and all previous easements and rights-of-way of record.

The basis for bearings is the east line of Section 11, being S 03°-54'-32"W, and all other bearings are from angles and distances measured in a field survey by Lee Surveying and Mapping Co., Inc. on October 31, 2016.

INDEXED ON MAP
92724

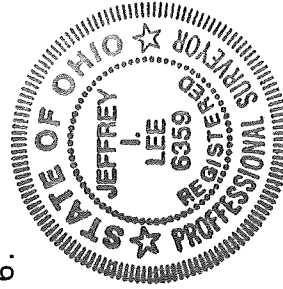

Description prepared by:

Jeffrey T. Lee
Professional Surveyor 6359

June 29, 2017

ORIGINAL STAMP IN GREEN

46440617B

APPROVED

7-12-17

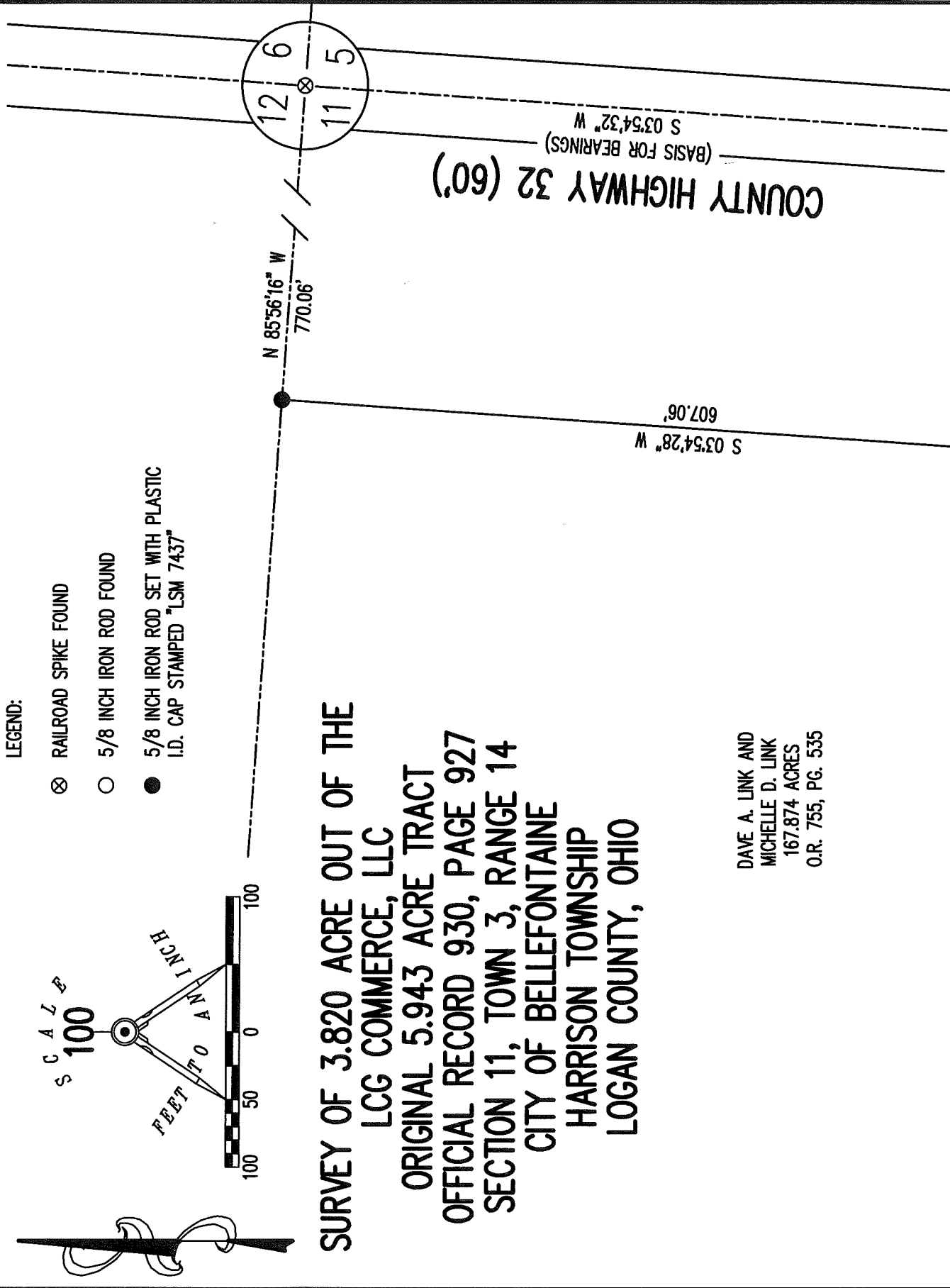

**SURVEY OF 3.820 ACRE OUT OF THE
 LCG COMMERCE, LLC
 ORIGINAL 5.943 ACRE TRACT
 OFFICIAL RECORD 930, PAGE 927
 SECTION 11, TOWN 3, RANGE 14
 CITY OF BELLEFONTAINE
 HARRISON TOWNSHIP
 LOGAN COUNTY, OHIO**

DAVE A. LINK AND
 MICHELLE D. LINK
 167.874 ACRES
 O.R. 755, PG. 535

3.820 ACRES
 LCG COMMERCE, LLC
 ORIGINAL 5.943 ACRES
 O.R. 930, PG. 927

CURVE C1
 DELTA ANGLE = 19°04'07"
 RADIUS = 330.00'
 ARC LENGTH = 109.92'
 CHORD BEARING = N 76°32'58" W
 CHORD LENGTH = 109.42'

INDEXED ON MAP
 9222-4

THIS SURVEY WAS PREPARED IN THE ABSENCE OF
 A COMPLETE AND ACCURATE TITLE SEARCH AND
 DOES NOT GUARANTEE TITLE.



CALL TOLL FREE **800-362-2764**
 OHIO UTILITIES PROTECTION SERVICE



SURVEYED BY:

JEFFREY L. LEE

PROFESSIONAL SURVEYOR 6359
 OCTOBER 31, 2016
 REVISED JUNE 29, 2017 (TO SHOW REMAINDER TRACT)

COPYRIGHT 2017 BY:
LEE SURVEYING & MAPPING CO., INC.
 117 North Madriver Street
 BELLEFONTAINE, OHIO 43311
 (937) 593-7335
 WWW.LSMINC.US
 surveys@lsminc.us

ORIGINAL STAMP IN GREEN

KSS D0617 46440617B L-4644-3

Lee Surveying and Mapping Co., Inc.

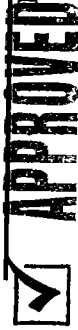

Land Surveys • Topography • Subdivisions • Construction Layout



117 N. Madriver St.
Bellefontaine OH 43311

Phone: (937) 593-7335
Fax: (937) 593-7444
surveys@lsminc.us

LINK 0.585 ACRE

Lying in Section 11, Town 3, Range 14, City of Bellefontaine, Harrison Township, Logan County, Ohio.

Being out of the Dave A. Link and Michelle D. Link, original 167.874 acre tract as deeded and described in Official Record 755, Page 535 of the Logan County Records of Deeds and being more particularly described as follows:

Commencing on a railroad spike found on the northeast corner of Section 11 on the center-line of County Highway 32.

THENCE, with the north line of Section 11, N 85°-56'-16"W, a distance of 770.06 feet to a 5/8 inch iron rod found.

THENCE, with the west line of the LCG Commerce, LLC, 8.324 acre tract (O.R. 1246, Pg. 476), S 03°-54'-28"W, a distance of 557.06 feet to a 5/8 inch iron rod set at the TRUE POINT OF BEGINNING.

THENCE, with the west line of the said 8.324 acre tract, S 03°-54'-28"W, a distance of 50.00 feet to a 5/8 inch iron rod found.

THENCE, with the north line of the LCG Commerce, LLC, original 5.943 acre tract (O.R. 930, Pg. 927), N 86°-05'-32"W, a distance of 510.00 feet to a 5/8 inch iron rod found.

THENCE, N 03°-54'-28"E, a distance of 50.00 feet to a 5/8 inch iron rod set.

THENCE, S 86°-05'-32"E, a distance of 510.00 feet to the point of beginning.

Containing 0.585 acre.

This parcel is to be attached to an adjoining tract of land and is not to be used as a separate and independent parcel.

Property is subject to any and all previous easements and rights-of-way of record.

The basis for bearings is the east line of Section 11, being S 03°-54'-32"W, and all other bearings are from angles and distances measured in a field survey by Lee Surveying and Mapping Co., Inc. on June 30, 2017.

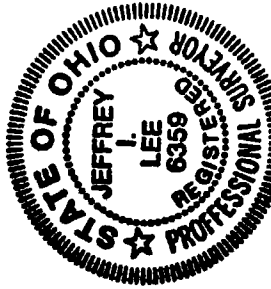

Description prepared by:

Jeffrey I. Lee
Professional Surveyor 6359
July 3, 2017

ORIGINAL STAMP IN GREEN

46440617

INDEXED ON MAP
927725

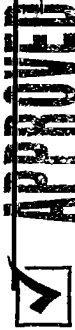

117 N. Madriver St.
Bellefontaine OH 43311

Phone: (937) 593-7335
Fax: (937) 593-7444
surveys@lsmc.us

LINK 14.345 ACRES

Lying in Section 11, Town 3, Range 14, City of Bellefontaine, Harrison Township, Logan County, Ohio.

Being out of the Dave A. Link and Michelle D. Link, original 167.874 acre tract as deeded and described in Official Record 755, Page 535 of the Logan County Records of Deeds and being more particularly described as follows:

Commencing on a railroad spike found on the northeast corner of Section 11 on the center-line of County Highway 32.

THENCE, with the north line of Section 11, N 85°-56'-16"W, a distance of 770.06 feet to a 5/8 inch iron rod found at the TRUE POINT OF BEGINNING.

THENCE, with the west line of the LCG Commerce, LLC, 8.324 acre tract (O.R. 1246, Pg. 476), S 03°-54'-28"W, a distance of 557.06 feet to a 5/8 inch iron rod set.

THENCE, N 86°-05'-32"W, a distance of 510.00 feet to a 5/8 inch iron rod set.

THENCE, with the west line extended and the west line of the LCG Commerce, LLC, original 5.943 acre tract (O.R. 930, Pg. 927), S 03°-54'-28"W, a distance of 375.00 feet to a 5/8 inch iron rod found, passing a 5/8 inch iron rod set at 50.00 feet.

THENCE, N 86°-05'-32"W, a distance of 367.85 feet to a 5/8 inch iron rod set.

THENCE, N 04°-19'-07"E, a distance of 934.44 feet to a 5/8 inch iron rod set on the north line of Section 11.

THENCE, with the north line of Section 11 and the south line of the Buckangehelas, LLC, 137.165 acre tract (O.R. 997, Pg. 771), S 85°-56'-16"E, a distance of 871.15 feet to the point of beginning.

Containing 14.345 acres.

This parcel is to be attached to an adjoining tract of land and is not to be used as a separate and independent parcel.

Property is subject to any and all previous easements and rights-of-way of record.

The basis for bearings is the east line of Section 11, being S 03°-54'-32"W, and all other bearings are from angles and distances measured in a field survey by Lee Surveying and Mapping Co., Inc. on June 30, 2017.

INDEXED ON MAP
9272
5

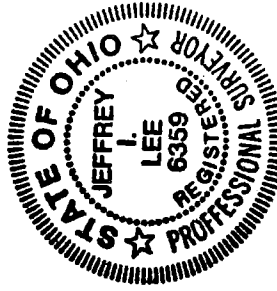

Description prepared by:

Jeffrey I. Lee
Professional Surveyor 6359
July 3, 2017

ORIGINAL STAMP IN GREEN

46440617

BUCKANGHELAS, LLC
 137.165 ACRES
 O.R. 997, PG. 771

- LEGEND:
- ⊗ RAILROAD SPIKE FOUND
 - 5/8 INCH IRON ROD FOUND
 - 5/8 INCH IRON ROD SET WITH PLASTIC I.D. CAP STAMPED "LSM 7437"

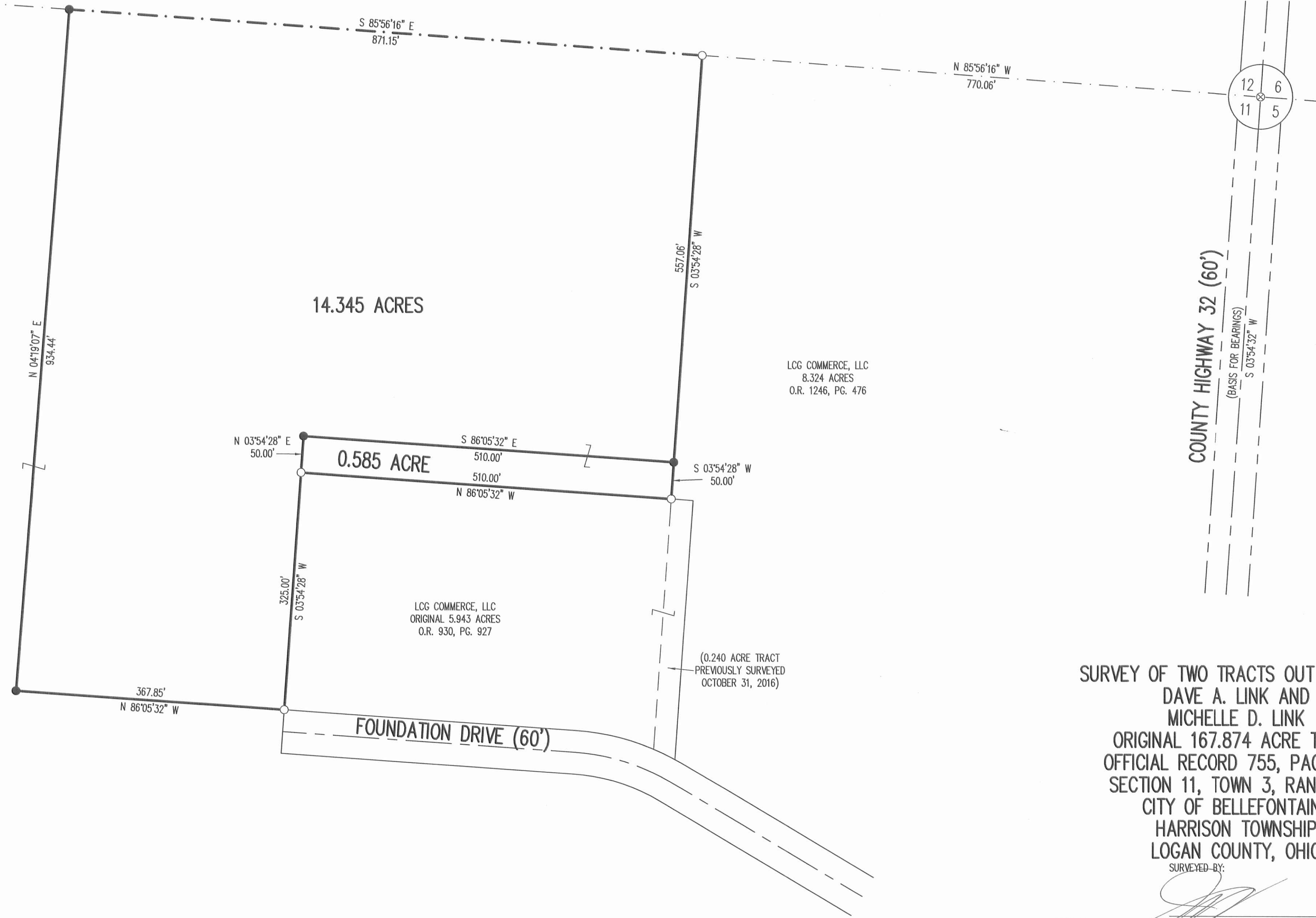
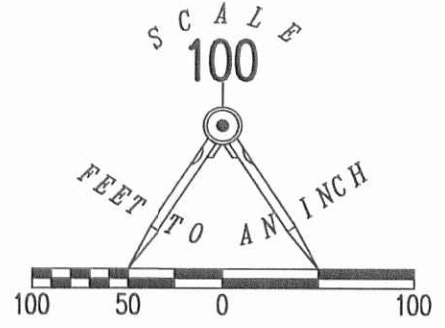

DAVE A. LINK AND
 MICHELLE D. LINK
 ORIGINAL 167.874 ACRES
 O.R. 755, PG. 535

LCG COMMERCE, LLC
 8.324 ACRES
 O.R. 1246, PG. 476

LCG COMMERCE, LLC
 ORIGINAL 5.943 ACRES
 O.R. 930, PG. 927

(0.240 ACRE TRACT
 PREVIOUSLY SURVEYED
 OCTOBER 31, 2016)



**SURVEY OF TWO TRACTS OUT OF THE
 DAVE A. LINK AND
 MICHELLE D. LINK
 ORIGINAL 167.874 ACRE TRACT
 OFFICIAL RECORD 755, PAGE 535
 SECTION 11, TOWN 3, RANGE 14
 CITY OF BELLEFONTAINE
 HARRISON TOWNSHIP
 LOGAN COUNTY, OHIO**

SURVEYED BY:

 JEFFREY I. LEE
 PROFESSIONAL SURVEYOR 6359
 JUNE 30, 2017

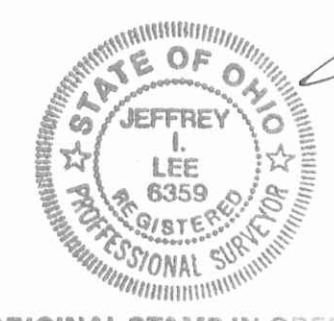

COPYRIGHT 2017 BY:
LEE SURVEYING & MAPPING CO., INC.
 117 North Madriver Street
 BELLEFONTAINE, OHIO 43311
 (937) 593-7335
 WWW.LSMINC.US
 surveys@lsminc.us
 KSS D0617 46440617 L-4644-2

THIS SURVEY WAS PREPARED IN THE ABSENCE OF
 A COMPLETE AND ACCURATE TITLE SEARCH AND
 DOES NOT GUARANTEE TITLE.

2 WORKING DAYS
BEFORE YOU DIG
 CALL TOLL FREE **800-362-2764**
OHIO UTILITIES PROTECTION SERVICE

NOTE:
 BOTH PARCELS ARE TO BE ATTACHED TO ADJOINING TRACTS
 OF LAND AND ARE NOT TO BE USED AS SEPARATE AND
 INDEPENDENT PARCELS.

INDEXED ON MAP
 9222 SP

8-11-17

Lee Surveying and Mapping Co., Inc.



Land Surveys • Topography • Subdivisions • Construction Layout

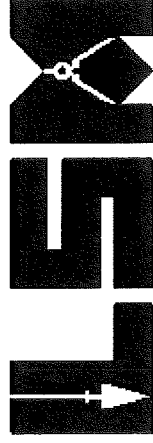

117 N. Madriver St.
Bellefontaine OH 43311

Phone: (937) 593-7335
Fax: (937) 593-7444
surveys@lsmc.us

LINK 10.00 FEET WIDE GAS LINE EASEMENT

Lying in Section 11, Town 3, Range 14, City of Bellefontaine, Harrison Township, Logan County, Ohio.

Being a 10.00 feet wide gas line easement over a portion of the Dave A. Link and Michelle D. Link original 167.874 acre tract as deeded and described in Official Record 755, Page 535 of the Logan County Records of Deeds and being more particularly described as follows:

Commencing on a railroad spike found on the northeast corner of Section 11 on the center-line of County Highway 32.

THENCE, with the east line of Section 11 and the center-line of County Highway 32 (60 feet wide), S 03°-54'-32"W, a distance of 660.83 feet to a point.

THENCE, with the center-line of the gas line easement extended, N 83°-12'-18"W, a distance of 30.04 feet to a point on the west right-of-way of County Highway 32 at the TRUE POINT OF BEGINNING.

THENCE, with the center-line of a 10.00 feet wide gas line easement, N 83°-12'-18"W, a distance of 380.52 feet to a point on the east line of the LCG Commerce LLC 8.324 acre tract (O.R. 1246, Page 476) at the terminus of said easement.

The sidelines of said easement to be shortened or prolonged to meet at angle point intersections.

Property is subject to any and all previous easements and rights-of-way of record.

The basis for bearings is the east line of Section 11, being S 03°-54'-32"W, and all other bearings are from angles and distances measured in a field survey by Lee Surveying and Mapping Co., Inc. on August 3, 2017.

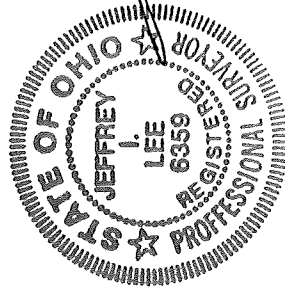

Description prepared by:

Jeffrey I. Lee
Professional Surveyor 6359
August 7, 2017

46440717

ORIGINAL STAMP IN GREEN



0-11-17

Lee Surveying and Mapping Co., Inc.



Land Surveys • Topography • Subdivisions • Construction Layout



117 N. Madriver St.
Bellefontaine OH 43311

Phone: (937) 593-7335
Fax: (937) 593-7444
surveys@lsminc.us

LCG COMMERCE LLC 10.00 FEET WIDE GAS LINE EASEMENT

Lying in Section 11, Town 3, Range 14, City of Bellefontaine, Harrison Township, Logan County, Ohio.

Being a 10.00 feet wide gas line easement over a portion of the LCG Commerce LLC, 8.324 acre tract as deeded and described in Official Record 1246, Page 476 of the Logan County Records of Deeds and being more particularly described as follows:

Commencing on a railroad spike found on the northeast corner of Section 11 on the center-line of County Highway 32.

THENCE, with the east line of Section 11 and the center-line of County Highway 32 (60 feet wide), S 03°-54'-32"W, a distance of 660.83 feet to a point.

THENCE, with the center-line of a gas line easement extended, N 83°-12'-18"W, a distance of 30.04 feet to a point on the west right-of-way of County Highway 32.

THENCE, with the center-line of a 10.00 feet wide gas line easement through the Dave A. Link and Michelle D. Link original 167.874 acre tract (O.R. 755, Pg. 535), N 83°-12'-18"W, a distance of 380.52 feet to a point on the west line of the said original 167.874 acre tract at the TRUE POINT OF BEGINNING.

THENCE, with the center-line of the gas line easement, the following two courses:

N 52°-17'-46"W, a distance of 73.58 feet to a point.

N 26°-52'-46"W, a distance of 51.90 feet to a point at the terminus of said easement.

The sidelines of said easement to be shortened or prolonged to meet at angle point intersections.

Property is subject to any and all previous easements and rights-of-way of record.

The basis for bearings is the east line of Section 11, being S 03°-54'-32"W, and all other bearings are from angles and distances measured in a field survey by Lee Surveying and Mapping Co., Inc. on August 3, 2017.

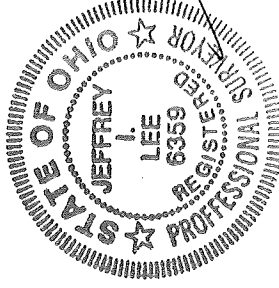

Description prepared by:

Jeffrey I. Lee
Professional Surveyor 6359
August 7, 2017

ORIGINAL STAMP IN GREEN

46440717



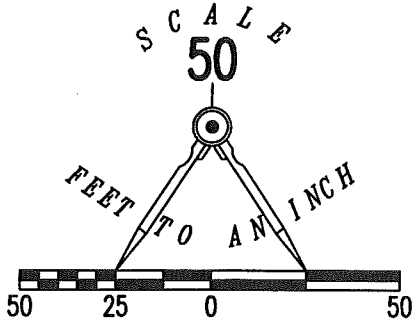

LEGEND:
 ⊗ RAILROAD SPIKE FOUND
 □ GAS METER

**SURVEY OF A 10.00 FEET WIDE
 GAS LINE EASEMENT THROUGH THE
 DAVE A. LINK AND
 MICHELLE D. LINK
 ORIGINAL 167.874 ACRE TRACT
 OFFICIAL RECORD 755, PAGE 535
 AND
 LCG COMMERCE LLC
 8.324 ACRE TRACT
 OFFICIAL RECORD 1246, PAGE 476
 SECTION 11, TOWN 3, RANGE 14
 CITY OF BELLEFONTAINE
 HARRISON TOWNSHIP
 LOGAN COUNTY, OHIO**

DAVE A. LINK AND
 MICHELLE D. LINK
 ORIGINAL 167.874 ACRES
 O.R. 755, PG. 535

WELD SHOP
 POURED CONCRETE WALLS
 METAL-SIDED BUILDING

METAL-SIDED
 BUILDING

TWO-STORY
 BRICK
 RESIDENCE

LCG COMMERCE LLC
 8.324 ACRES
 O.R. 1246, PG. 476

LINE	BEARING	DISTANCE
L1	N 83°12'18" W	380.52'
L2	N 52°17'46" W	73.58'
L3	N 26°52'46" W	51.90'

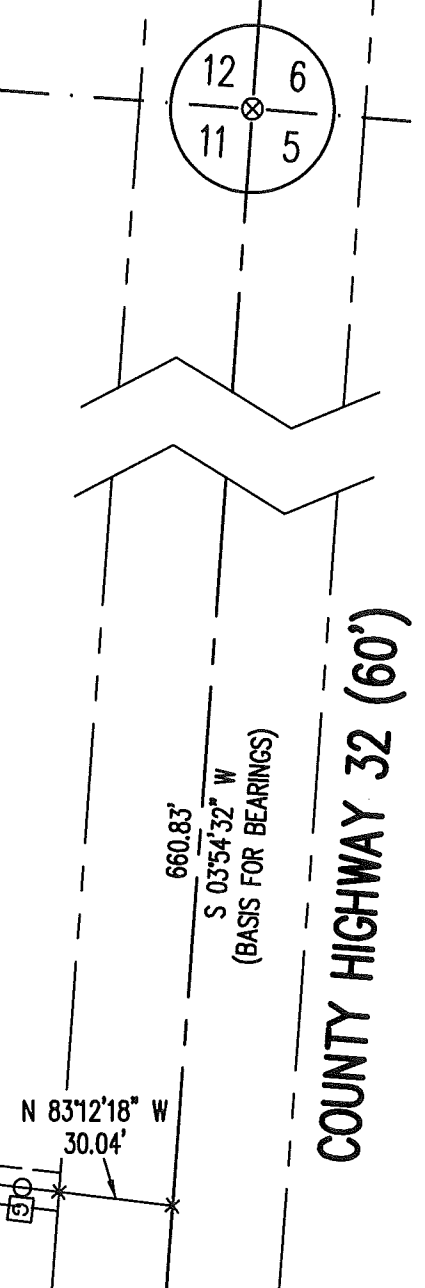

SURVEYED BY:

JEFFREY K. LEE
 PROFESSIONAL SURVEYOR 6359
 AUGUST 3, 2017

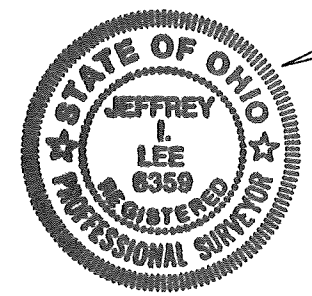

ORIGINAL STAMP IN GREEN

COPYRIGHT 2017 BY:
LEE SURVEYING & MAPPING CO., INC.
 117 North Madriver Street
 BELLEFONTAINE, OHIO 43311
 (937) 593-7335
 WWW.LSMINC.US
 surveys@lsminc.us
 KSS D0717 46440717 L-4644-3

THIS SURVEY WAS PREPARED IN THE ABSENCE OF
 A COMPLETE AND ACCURATE TITLE SEARCH AND
 DOES NOT GUARANTEE TITLE.

2 WORKING DAYS
BEFORE YOU DIG
 CALL TOLL FREE **800-362-2764**
 OHIO UTILITIES PROTECTION SERVICE.

INDEXED ON MAP
 9272 4P