

MARELM MEADOWS SUBDIVISION

VIRGINIA MILITARY SURVEY 3220, JEFFERSON TOWNSHIP
LOGAN COUNTY, OHIO

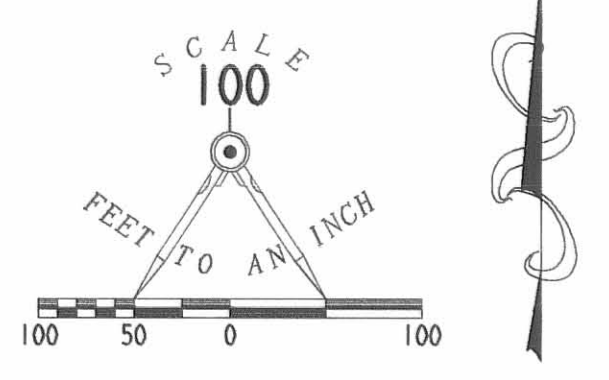

VIRGINIA MILITARY SURVEY 5738
VIRGINIA MILITARY SURVEY 3220



- LEGEND
- 5/8" INCH IRON ROD TO BE SET UPON COMPLETION OF CONSTRUCTION
 - 5/8" IRON ROD SET
 - 5/8" INCH IRON ROD FOUND
 - CONCRETE MONUMENT TO BE SET UPON COMPLETION OF CONSTRUCTION
 - MAG NAIL TO BE SET UPON COMPLETION OF CONSTRUCTION
 - ⊕ MAG NAIL SET
 - ⊞ STONE FOUND
 - ⊙ 6" WOOD POST FOUND

NOTES:

IN ADDITION TO OTHER EASEMENTS SHOWN OR NOTED, AN EXCLUSIVE TWO FEET DIAMETER EASEMENT IS RESERVED AT ALL PROPERTY CORNERS AND POINTS OF CURVATURE FOR MONUMENTATION. NO SURFACE OR BURIED UTILITIES OF ANY KIND MAY BE PLACED WITHIN THESE EASEMENT AREAS.

THE UTILITY EASEMENTS INDICATED ON THIS PLAT ARE FOR THE ERECTION, CONSTRUCTION, MAINTENANCE, REPAIR, AND INSTALLATION OF ANY OR ALL UTILITIES, BOTH PUBLIC AND PRIVATE FOR USE WITHIN THE MARELM MEADOWS SUBDIVISION. IT SHALL BE LAWFUL FOR ANY SUCH UTILITY, PUBLIC OR PRIVATE, OR ITS EMPLOYEES OR REPRESENTATIVES OR ANYONE ACTING FOR ANY SUCH UTILITY TO ENTER UPON SAID EASEMENT OR RIGHT-OF-WAY AT ANY TIME FOR THE PURPOSE OF CARRYING OUT THE OBJECTIVES FOR WHICH SUCH EASEMENTS OR RIGHTS-OF-WAY WERE RESERVED. NO STRUCTURES OR PLANTINGS ARE PERMITTED WITHIN ANY UTILITY EASEMENT.

ANY IMPROVEMENTS WHICH ARE PART OF THE DRAINAGE SYSTEM USED FOR THE DETENTION AND TRANSPORT OF SURFACE AND STORM WATERS FROM THE MARELM MEADOWS SUBDIVISION, OR WHICH ARE NECESSARY TO SUPPORT AND OPERATE SUCH DRAINAGE SYSTEM, INCLUDING WITHOUT LIMITATION, SUBSURFACE TILE AND CURTAIN DRAIN OUTLETS, MAY BE LOCATED ON OR WITHIN ANY UTILITY EASEMENTS INDICATED ON THIS PLAT.

EXCEPT AS SHOWN TO BE MORE RESTRICTIVE, BUILDING SETBACK DISTANCES SHALL CONFORM TO JEFFERSON TOWNSHIP ZONING REGULATIONS.

THIS PLAT CONSISTS OF TWO (2) PAGES, AND BOTH PAGES MUST BE USED FOR A COMPLETE REPRESENTATION OF THIS SUBDIVISION.

BY GRAPHIC PLOTTING ONLY, THE AREA SHOWN HEREON IS IN FLOOD ZONE "C". AREA OF MINIMAL FLOODING PER THE FLOOD INSURANCE RATE MAP PANEL NUMBER 390772 0120 C, DATED MAY 15, 1985. NO FIELD SURVEY WAS PERFORMED TO DETERMINE THIS ZONE.

THE SUBDIVISION PLAT SATISFIES THE REQUIREMENTS OF 711.02(B).

SURVEYOR'S CERTIFICATION

THE ACCOMPANYING PLAT REPRESENTS A SUBDIVISION OF LAND IN VIRGINIA MILITARY SURVEY 3220, JEFFERSON TOWNSHIP, LOGAN COUNTY, OHIO.

THE TRACT HAS A TOTAL AREA OF 49.733 ACRES, OF WHICH 6.302 ACRES ARE WITHIN THE STREET RIGHTS-OF-WAY, LEAVING 43.431 ACRES IN 34 RESIDENTIAL BUILDING LOTS.

ALL MEASUREMENTS ARE IN FEET AND DECIMAL PARTS THEREOF

I HEREBY STATE THAT THE ACCOMPANYING PLAT IS A CORRECT REPRESENTATION OF MARELM MEADOWS SUBDIVISION AS SURVEYED IN APRIL OF 2000, AND THAT ALL MONUMENTS ARE AS SHOWN HEREON HAVE BEEN FOUND, SET, OR WILL BE SET UPON COMPLETION OF CONSTRUCTION AT A TIME AS DIRECTED BY THE PROPRIETORS.



JEFFREY J. LEE
PROFESSIONAL SURVEYOR 6359
APRIL 28, 2000

DEVELOPER
MARELM LLC
4392 TOWNSHIP ROAD 148
EAST LIBERTY, OHIO 43319
(937) 666-4903

DEDICATION

KNOW ALL MEN BY THESE PRESENTS THAT MARELM, LLC, OWNERS OF THE LAND INDICATED ON THE ACCOMPANYING PLAT, HAS AUTHORIZED THE PLATTING THERON AND DOES HEREBY DEDICATE THE STREETS TO THE PUBLIC USE FOREVER. IT WILL DIRECT THE SURVEYOR TO PLACE THE MONUMENTS SHOWN HEREON UPON COMPLETION OF THE CONSTRUCTION FOR WHICH SURETY IS POSTED.

WITNESSES
SIGNATURE Roger D. Kennard
PRINTED NAME Roger D. Kennard
SIGNATURE Loretta Pool
PRINTED NAME LORETTA POOL

OWNER
MARELM LLC
Elmer D. Bible
BY ELMER D. BIBLE, MANAGER

STATE OF OHIO SS:
COUNTY OF LOGAN

BEFORE ME A NOTARY PUBLIC IN AND FOR THE SAID COUNTY PERSONALLY CAME ELMER D. BIBLE, MANAGER OF MARELM, LLC, WHO ACKNOWLEDGES THE SIGNING OF THE FOREGOING INSTRUMENT TO BE HIS VOLUNTARY ACT AND DEED AND VOLUNTARY ACT AND DEED OF MARELM, LLC, FOR THE USES AND PURPOSES THEREIN EXPRESSED.

IN WITNESS WHEREOF, I HAVE HERETO SET MY HAND AND AFFIXED MY OFFICIAL SEAL THIS

8 DAY OF February 2001

Roger D. Kennard
NOTARY PUBLIC

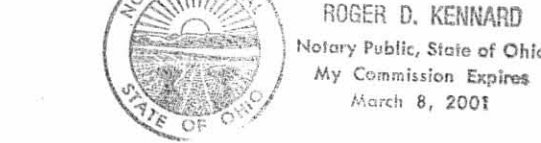

APPROVALS

PLAT PRE-APPROVED Jon C. Hill 2-8-01

PLAT CHECKED Jon C. Hill 2-16-01

REVIEWED THIS 14 DAY OF February 2001. Jim Umsted
CHAIRMAN JEFFERSON TOWNSHIP TRUSTEES

APPROVED THIS 8th DAY OF February 2001. Samuel K. Lee
LOGAN COUNTY ENGINEER

THE SIGNATURE OF THE LOGAN COUNTY HEALTH COMMISSIONER APPROVING THIS PLAT SHALL IN NO WAY INDICATE, INFER OR BE CONSTRUED TO MEAN THAT INDIVIDUAL SEWAGE TREATMENT SYSTEMS ARE OR HAVE BEEN APPROVED FOR ANY LOT. EACH LOT OWNER SHALL BE REQUIRED TO OBTAIN APPROVAL OF THE LOGAN COUNTY GENERAL HEALTH DISTRICT IN ORDER FOR A SEWAGE TREATMENT SYSTEM TO BE CONSTRUCTED AND OPERATED ON SUCH OWNER'S LOT, IN ACCORDANCE WITH THE LAWS OF THE STATE OF OHIO, AND THE RULES AND REGULATIONS PROMULGATED BY OR APPLICABLE TO THE LOGAN COUNTY GENERAL HEALTH DISTRICT.

APPROVED THIS 9th DAY OF February, 2001. W. J. Schellert
LOGAN COUNTY HEALTH DEPARTMENT

THE WITHIN STREETS ARE HEREBY APPROVED AND ACCEPTED FOR PUBLIC MAINTENANCE BY RESOLUTION NO. _____ RECORDED IN THE LOGAN COUNTY COMMISSIONERS' JOURNAL ON THIS _____ DAY OF _____, 20 ____.

APPROVED THIS 8 DAY OF February 2001. Gregory J. Harris
LOGAN-UNION-CHAMPAIGN REGIONAL PLANNING COMMISSION

APPROVED THIS 15th DAY OF February, 2001. Samuel K. Lee
John Bayliss
Paul Rosen
LOGAN COUNTY COMMISSIONERS

TRANSFERRED THIS 16th DAY OF February, 2001. Michael E. Yoder
AUDITOR, LOGAN COUNTY, OHIO

FILED FOR RECORD THIS 16th DAY OF February, 2001, AT P.M. 2:09

RECORDED THIS 16th DAY OF February, 2001. IN PLAT CABINET B, SLIDE 59B & 60A

Linda Hanson
RECORDER, LOGAN COUNTY, OHIO

CURVE	DELTA ANGLE	RADIUS	ARC	TANGENT	CHORD	CHORD BEARINGS	CURVE	DELTA ANGLE	RADIUS	ARC	TANGENT	CHORD	CHORD BEARINGS
C 1	92°43'17"	35.00'	56.64'	36.70'	50.66'	N 38°34'07"W	C 15	118°00'00"	70.00'	144.16'	116.50'	120.00'	S 73°09'20"W
C 2	80°54'55"	25.00'	35.31'	21.32'	32.44'	N 45°22'21"E	C 16	90°05'35"	65.00'	102.21'	65.11'	92.00'	N 49°57'41"E
C 3	98°38'35"	70.00'	120.52'	81.44'	106.17'	N 36°30'31"E	C 17	87°16'43"	35.00'	53.32'	33.38'	48.31'	N 51°25'53"E
C 4	90°09'43"	70.00'	110.15'	70.20'	99.13'	N 57°53'38"W	C 18	72°06'37"	70.00'	88.10'	50.96'	82.40'	S 40°58'12"W
C 5	90°05'35"	35.00'	55.03'	35.06'	49.54'	S 49°57'41"W	C 19	35°54'55"	70.00'	43.88'	22.69'	43.16'	S 58°02'34"E
C 6	92°47'03"	35.00'	56.68'	36.74'	50.69'	N 38°36'00"E	C 20	80°54'55"	25.00'	35.31'	21.32'	32.44'	S 35°32'34"E
C 7	87°12'57"	35.00'	53.28'	33.34'	48.28'	N 51°24'00"E	C 21	55°09'00"	70.00'	67.38'	36.56'	64.81'	N 67°29'45"E
C 8	36°15'36"	95.00'	60.12'	31.11'	59.12'	N 76°52'41"E	C 22	87°45'55"	70.00'	107.23'	67.32'	97.05'	N 03°57'43"W
C 9	53°49'59"	95.00'	89.26'	48.23'	86.01'	N 31°49'53"E							
C 10	80°54'55"	25.00'	35.31'	21.32'	32.44'	S 54°36'47"W							
C 11	51°56'49"	70.00'	63.47'	34.10'	61.31'	N 21°03'31"W							
C 12	173°03'11"	70.00'	211.42'	1153.26'	139.74'	S 46°26'29"W							
C 13	89°54'25"	35.00'	54.92'	34.94'	49.46'	S 40°02'19"E							
C 14	90°05'35"	35.00'	55.03'	35.06'	49.54'	N 49°57'41"E							

2 WORKING DAYS
BEFORE YOU DIG
CALL TOLL FREE 800-362-2764
OHIO UTILITIES PROTECTION SERVICE.

COPYRIGHT 2000 BY:
LEE SURVEYING & MAPPING CO., INC.
117 North Madison Street
BELLEVILLE, OHIO 45311
(937) 593-7335

D 360 BIBLPLAT
PRINTED JANUARY 17, 2001

L-2830-2

MARELM MEADOWS SUBDIVISION

VIRGINIA MILITARY SURVEY 3220, JEFFERSON TOWNSHIP
LOGAN COUNTY, OHIO

DESCRIPTION

LYING IN VIRGINIA MILITARY SURVEY 3220, JEFFERSON TOWNSHIP, LOGAN COUNTY, OHIO

BEING ALL OF THE MARELM, LLC 49.733 ACRE TRACT AS DEEDED AND DESCRIBED IN OFFICIAL RECORD 479, PAGE 501, OF THE LOGAN RECORDS OF DEEDS AND BEING MORE PARTICULARLY DESCRIBED AS FOLLOWS:

BEGINNING AT A STONE FOUND AT THE INTERSECTION OF THE CENTER-LINE OF TOWNSHIP ROAD 55 AND THE NORTH LINE OF VIRGINIA MILITARY SURVEY 3220.

THENCE WITH THE NORTH LINE OF VIRGINIA MILITARY SURVEY 3220 AND THE SOUTH LINE OF THE WALTER L. LAMB ORIGINAL 147.66 ACRE TRACT (VOL. 355, PAGE 244, TRACT 11), S 84°55'45" E, A DISTANCE OF 1612.62 FEET TO A 5/8 INCH IRON ROD FOUND, PASSING A 5/8 INCH IRON ROD SET AT 30.03 FEET.

THENCE WITH THE WEST LINE OF THE JOHN R. HORTON ORIGINAL 124.564 ACRE TRACT (O.R. 338, PG. 466) S 4°54'54" W, A DISTANCE OF 1313.86 FEET TO A 6 INCH WOOD POST FOUND.

THENCE WITH THE NORTH LINE OF THE HAROLD M. JACKSON ORIGINAL 48.51 ACRE TRACT (VOL. 382, PAGE 553), N 84°59'31" W, A DISTANCE OF 1706.29 FEET TO A MAG NAIL SET, PASSING A 5/8 INCH IRON ROD SET AT 1628.47 FEET.

THENCE WITH THE CENTER-LINE OF TOWNSHIP ROAD 55 (150 FEET WIDE), N 15°45'32" E, A DISTANCE OF 198.50 FEET TO A STONE FOUND.

THENCE CONTINUING WITH THE CENTER-LINE OF TOWNSHIP ROAD 55, N 7°47'32" E, A DISTANCE OF 1121.93 FEET TO THE POINT OF BEGINNING.

CONTAINING 49.733 ACRES, OF WHICH 0.989 ACRE IS WITHIN THE HIGHWAY RIGHT-OF-WAY.

THE BASIS FOR BEARINGS IS THE NORTH LINE OF VIRGINIA MILITARY SURVEY 3220, BEING S 84°55'45" E, AND ALL OTHER BEARINGS ARE FROM ANGLES AND DISTANCES MEASURED IN A FIELD SURVEY BY LEE SURVEYING AND MAPPING CO., INC. ON JANUARY 28, 2000.

COVENANTS AND RESTRICTIONS

AS A PART OF THE CONSIDERATION FOR THE CONVEYANCE, THE GRANTEES FOR THEMSELVES AND THEIR HEIRS AND ASSIGNS, AGREE AS FOLLOWS:

- 1) LOT SPLIT. NO LOT SHALL BE SPLIT, DIVIDED, OR SUBDIVIDED FOR SALE, RESALE, GIFT, TRANSFER, OR OTHERWISE, SO AS TO CREATE A NEW BUILDING LOT. NOTHING UNDER THIS PARAGRAPH SHALL RESTRICT THE PROPRIETOR OR SUBSEQUENT OWNERS FROM DIVIDING A LOT IN SUCH A WAY THAT IT DOES NOT CREATE A NEW BUILDING LOT.
- 2) LAND USE. ALL LOTS IN THIS TRACT SHALL BE KNOWN AND DESCRIBED AS SINGLE FAMILY RESIDENTIAL LOTS. NO STRUCTURE SHALL BE ERRECTED, ALTERED, PLACED OR PERMITTED TO REMAIN ON ANY RESIDENTIAL BUILDING PLOT OTHER THAN ONE DETACHED SINGLE-FAMILY DWELLING NOT TO EXCEED TWO AND ONE-HALF (2-1/2) STORIES IN HEIGHT WITH A MINIMUM OF A TWO CAR ATTACHED GARAGE, EXCEPT THAT ONE UNATTACHED NON-RESIDENTIAL OUT BUILDING OR SHED IS PERMITTED. ANY SUCH UNATTACHED BUILDING OR SHED SHALL BE LOCATED NOT LESS THAN 60 FEET FROM ANY RESIDENCE. OUT BUILDINGS SHALL CONFORM WITH THE ARCHITECTURAL STYLE OF THE RESIDENCE HOUSE, INCLUDING WITHOUT LIMITATION, THE ROOF PITCH REQUIRED HEREUNDER FOR THE RESIDENCE HOUSE.
- 3) MOBILE HOMES. NO MOBILE HOMES OR MODULAR HOUSING SHALL BE PERMITTED ON ANY LOT FOR ANY PURPOSE, INCLUDING STORAGE THEREOF, IT BEING THE INTENTION OF THIS RESTRICTION TO PROHIBIT ANY HOUSING THAT HAS, OR HAD AT ANY TIME, A CERTIFICATE OF TITLE OR A MANUFACTURER'S STATEMENT OF ORIGIN AND TO REQUIRE THAT ALL HOMES BUILT IN MARELM MEADOWS SHALL BE CUSTOM STICK BUILT ON THE PREMISES, OR SHALL BE MANUFACTURED (INDUSTRIALIZED) HOMES.
- 4) MINIMUM LIVING AREA. RESIDENCE HOMES SHALL HAVE A MINIMUM LIVING AREA OF 1500 SQUARE FEET FOR A ONE STORY HOME AND 1500 SQUARE FEET FOR A MULTILEVEL HOME, EXCLUSIVE OF PORCHES, GARAGES, AND BASEMENTS.
- 5) PLAN APPROVAL. FOR THE PURPOSES OF MAINTAINING SPECIFIC ARCHITECTURAL GUIDELINES AND STANDARDS FOR THE DEVELOPMENT OF ALL THE LOTS WITHIN MARELM MEADOWS, EACH OWNER OF A LOT SHALL BE REQUIRED TO SUBMIT TWO (2) SETS OF COMPLETE BUILDING AND SITE PLANS TO THE PROPRIETOR, MARELM LLC, SETTING FORTH THE GENERAL ARRANGEMENTS OF THE INTERIOR AND EXTERIOR OF THE STRUCTURE, INCLUDING THE COLOR AND TEXTURE OF THE BUILDING MATERIALS, THE TYPE AND CHARACTER OF ALL SUCH AS DECORATIVE WALLS, CHIMNEYS, DRIVEWAYS AND WALKWAYS AND DETAILING THE LOCATION OF THE STRUCTURE ON THE LOT INCLUDING SETBACKS, DRIVEWAY LOCATIONS, GARAGE OPENINGS, ORIENTATION OF THE STRUCTURE TO THE TOPOGRAPHY AND CONFORMANCE WITH THE GRADING AND DRAINAGE PLAN.

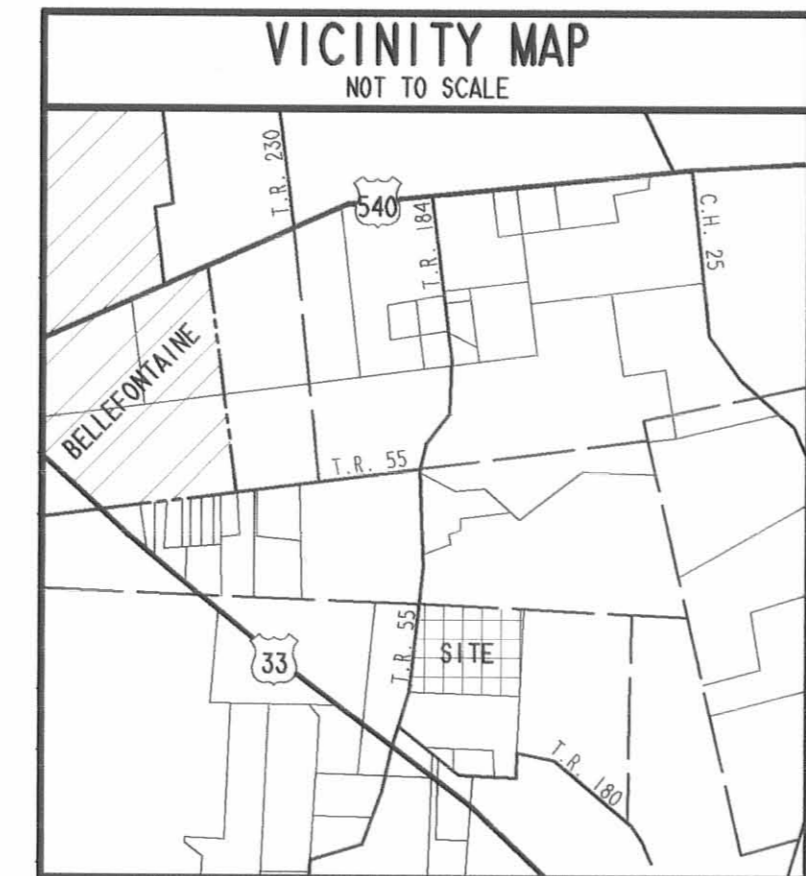

EACH OWNER COVENANTS THAT NO EXCAVATION SHALL BE MADE, NO BUILDING SHALL BE ERRECTED AND NO MATERIALS SHALL BE STORED UPON THE PREMISES UNTIL THE PROPRIETOR SHALL HAVE APPROVED SAID PLANS AND SPECIFICATIONS IN WRITING, WHICH APPROVAL SHOULD NOT BE UNREASONABLY WITHHELD.

- 6) EASEMENT. ALL EASEMENTS OR RIGHTS-OF-WAY INDICATED ON THIS PLAT ARE FOR THE ERECTION, CONSTRUCTION, MAINTENANCE REPAIR AND INSTALLATION OF ANY OR ALL UTILITIES, BOTH PUBLIC AND PRIVATE. IT SHALL BE LAWFUL FOR ANY SUCH UTILITY, PUBLIC OR PRIVATE, OR ITS EMPLOYEES OR REPRESENTATIVES OR ANYONE ACTING FOR ANY SUCH UTILITY TO ENTER UPON SAID EASEMENT OR RIGHT-OF-WAY AT ANY TIME FOR THE PURPOSE OF CARRYING OUT THE OBJECTIVES FOR WHICH SUCH EASEMENTS OR RIGHTS-OF-WAY WERE RESERVED. IN ADDITION TO EASEMENTS SHOWN ON THE MARELM MEADOWS SUBDIVISION PLAT, A ONE FOOT DIAMETER EXCLUSIVE EASEMENT IS RESERVED AT ALL PROPERTY CORNERS AND CHANGES IN PROPERTY DIRECTION FOR MONUMENTATION AND NO SURFACE OR BURIED UTILITIES OF ANY KIND SHALL OBSTRUCT THIS EASEMENT, NO STRUCTURES OR PLANTINGS ARE PERMITTED WITHIN ANY EASEMENT.
- 7) DRAINAGE. NO CONSTRUCTION, GRADING OR OTHER IMPROVEMENTS SHALL BE MADE TO THE REAL ESTATE IF SUCH CONSTRUCTION, GRADING OR OTHER IMPROVEMENT WOULD INTERFERE OR OTHERWISE ALTER THE GENERAL GRADING AND DRAINAGE PLAN OF THE SURROUNDING REAL ESTATE OR ANY EXISTING SWALES, FLOODWAYS OR OTHER DRAINAGE CONFIGURATIONS.
- 8) WALLS AND FENCES. NO WALLS OR FENCES OF ANY TYPE (EXCEPT FOR HEDGES ALLOWABLE PURSUANT TO PARAGRAPH 9) SHALL BE ERRECTED OR MAINTAINED ON ANY LOT IN THE AREA EXTENDING BETWEEN SIDE LOT LINES ACROSS THE FRONT OF A LOT AND FROM THE FRONT LOT LINE TO THE FRONT OF THE RESIDENCE HOUSE. PROPERTY LINE FENCES TO THE REAR AND THE SIDES SHALL BE ESTHETICALLY CONSTRUCTED AND MAINTAINED AND NO GREATER THAN 6 FEET IN HEIGHT, EXCEPT FOR FENCES AROUND SWIMMING POOLS WHICH SHALL COMPLY WITH JEFFERSON TOWNSHIP REGULATIONS. NO CHAIN-LINK FENCES SHALL BE PERMITTED ON ANY LOT.
- 9) HEDGES. NO HEDGE (I.E., A ROW OF CLOSELY PLANTED SHRUBS OR LOW-GROWING TREES FORMING A BOUNDARY OR FENCE) WITHIN THE FRONT 50-FOOT SET BACK AREA SHALL HAVE A HEIGHT OF MORE THAN 3 FEET ABOVE THE FINISHED GRADED SURFACE AT THE HEDGE.
- 10) GRADING. RESIDENCE LOTS SHALL BE PROPERLY GRADED TO FIT THE EXISTING TOPOGRAPHY OF SUCH LOTS AND SUCH GRADED AREAS SHALL BE SEEDED TO A LAWN WITHIN TWELVE MONTHS OF TAKING OCCUPANCY.
- 11) DRIVEWAYS. ALL DRIVEWAYS MUST BE ASPHALT CONCRETE OR CONCRETE, AND MUST BE COMPLETED WITHIN ONE (1) YEAR FROM THE TIME OCCUPANCY OF THE RESIDENCE OCCURS. NO DRIVEWAY MAY ENTER A LOT FROM TOWNSHIP ROAD 55. ALL DRIVEWAYS MUST ENTER A LOT FROM ONE OF THE STREETS LOCATED WITHIN THE DEVELOPMENT.
- 12) SIDEWALKS. CONCRETE OR BRICK SIDEWALKS SHALL BE PROVIDED FROM THE FRONT DOOR OF THE RESIDENCE TO THE DRIVEWAY. SAID SIDEWALKS MUST BE A MINIMUM OF 4 FEET WIDE.
- 13) BUILDING EXITS. RESIDENCES SHALL HAVE FRONT AND REAR OR SIDE DOOR EXITS.
- 14) ROOF OF BUILDING. THE SLOPE OF THE ROOF ON ALL ONE STORY BUILDINGS SHALL BE A RATIO OF NOT LESS THAN 6 FEET VERTICAL FOR EACH 12 FEET FOR HORIZONTAL.
- 15) SETBACK LINES. THE BUILDING SET BACK LINES SHALL BE AS DEPICTED ON THE DEVELOPMENT PLAT. IF NOT DEPICTED ON THE DEVELOPMENT PLAT, ALL FRONT SET BACK LINES SHALL BE NOT LESS THAN 50 FEET FROM THE FRONT LOT LINE. ALL SIDE SET BACK LINES SHALL BE NOT LESS THAN 20 FEET FROM THE SIDE LOT LINES, AND ALL REAR SET BACK LINES SHALL BE NOT LESS THAN 30 FEET FROM THE REAR LOT LINE.
- 16) TEMPORARY STRUCTURE. NO TRAILER, MOTOR HOME, BASEMENT, TENT, SHACK, GARAGE, BARN, OR OTHER OUTBUILDINGS SHALL BE USED AS A RESIDENCE, TEMPORARILY OR PERMANENTLY, NOR SHALL ANY STRUCTURE OF A TEMPORARY CHARACTER BE USED AS A RESIDENCE.
- 17) WASTE DISPOSAL. NO LOT SHALL BE USED OR MAINTAINED AS A DUMPING GROUND FOR RUBBISH, TRASH, GARBAGE, OR OTHER WASTE SHALL NOT BE KEPT EXCEPT IN SANITARY CONTAINERS. ALL EQUIPMENT FOR THE STORAGE OR DISPOSAL OF SUCH MATERIALS SHALL BE KEPT IN A CLEAN AND SANITARY CONDITION AND REMOVED FROM VIEW OF ADJUTING PROPERTIES.
- 18) MOWING. ALL LOTS WHICH HAVE BEEN DEVELOPED BUT NOT BUILT UPON SHALL BE MAINTAINED BY THE OWNERS OF SUCH LOTS TO INCLUDE AT LEAST TWO (2) MOWINGS EACH, NOT LATER THAN JUNE 15 FOR THE FIRST MOWING AND SEPTEMBER 15 FOR THE SECOND MOWING.

19) ACTIVITIES PROHIBITED. NO NOXIOUS OR OFFENSIVE TRADE SHALL BE TRANSACTED ON ANY LOT, INCLUDING THE MANUFACTURE OR SALE OF INTOXICATING LIQUOR, NOR SHALL ANYTHING BE DONE THEREON WHICH MAY BE OR BECOME AN ANNOYANCE OR NUISANCE TO THE NEIGHBORHOOD, NOR SHALL THE PREMISES BE USED, IN ANY WAY, FOR ANY PURPOSE WHICH WOULD ENDANGER THE HEALTH OR DISTURB THE PEACE AND QUIET OF THE SUBDIVISION. NO MORE THAN 2 "GARAGE SALES" OR "YARD SALES" SHALL BE PERMITTED ON ANY LOT DURING ANY CALENDAR YEAR. NO COMMERCIAL TRADE OR BUSINESS MAY BE CONDUCTED ON ANY LOT IF SUCH TRADE OR BUSINESS INVOLVES A SOLICITATION OF BUSINESS FROM THE GENERAL PUBLIC, INCREASES THE TRAFFIC FLOW WITHIN THE DEVELOPMENT, AND CONSISTENTLY INVOLVES CUSTOMERS FROM THE GENERAL PUBLIC PARKING ON THE LOT IN QUESTION OR ON ANY OTHER AREA WITHIN THE DEVELOPMENT, INCLUDING WITHOUT LIMITATION, THE STREETS WITHIN THE DEVELOPMENT.

20) VEHICLE STORAGE. NO RECREATIONAL VEHICLES, SNOWMOBILES, BOATS, MOTORCYCLES, TRAILERS, CAMPERS, LARGE TRUCKS DESIGNED WITH A CARGO WEIGHT IN EXCESS OF 1 GROSS TON, AND OTHER SIMILAR VEHICLES SHALL BE STORED ON ANY LOT UNLESS SUCH VEHICLES ARE STORED WITHIN THE GARAGE OR OUTBUILDING. NO SUCH VEHICLES SHALL BE PARKED ON THE STREETS OF THE DEVELOPMENT, EXCEPT FOR LARGE TRUCKS DESIGNED WITH A CARGO WEIGHT IN EXCESS OF 1 GROSS TON WHICH ARE IN THE PROCESS OF MOVING OR DELIVERING FURNITURE AND/OR APPLIANCES AT THE RESIDENCE WHERE SUCH TRUCKS ARE TEMPORARILY PARKED.

21) VEHICLES NOT IN USE. NO NON-FUNCTIONING AUTOMOBILE OR MOTOR VEHICLE SHALL BE PARKED MORE THAN 30 DAYS ON ANY STREET OR LOT, EXCEPT WHEN WITHIN THE GARAGE OR OUTBUILDING. AFTER SUCH A PERIOD, THE VEHICLE SHALL BE CONSIDERED A NUISANCE AND DETRIMENTAL TO THE WELFARE OF THE SUBDIVISION AND SHALL BE REMOVED THEREFROM.

22) SIGNS. NO LIGHTED OR PERMANENT TYPE SIGN SHALL BE ERRECTED ON ANY LOT IN THIS SUBDIVISION, EXCEPT: (1) SO LONG AS THE PROPRIETOR OWNS LOTS IN THE SUBDIVISION; SIGN PLACEMENT WILL BE AT THE DISCRETION OF THE PROPRIETOR AND CURRENT LOCAL ZONING ORDINANCES; (2) ONE SIGN OF NOT MORE THAN THREE FEET SQUARE MAY BE USED TO ADVERTISE A LOT FOR SALE; AND (3) SIGNS MAY BE USED BY A BUILDER DURING THE PERIOD OF CONSTRUCTION ON A LOT.

23) ANIMALS. NO ANIMALS, BIRDS, INSECTS, LIVESTOCK, OR POULTRY OF ANY KIND SHALL BE RAISED, BRED, OR KEPT ON ANY LOT EXCEPT DOGS, CATS OR OTHER HOUSEHOLD PETS WHICH ARE KEPT FOR DOMESTIC PURPOSES ONLY, AND ARE NOT KEPT, BRED OR MAINTAINED FOR ANY COMMERCIAL PURPOSE. NO MORE THAN TWO DOGS AND TWO CATS MAY BE KEPT ON ANY LOT EXCEPT SUCH DOGS OR CATS IN EXCESS OF SUCH NUMBERS THAT ARE LESS THAN THREE MONTHS OF AGE. ALL ANIMALS MUST BE RESTRAINED ON THE OWNER'S LOT AND OWNERS SHALL TAKE ALL STEPS NECESSARY TO INSURE THE SAME.

24) STORM DETENTION EASEMENT. STORM DETENTION EASEMENTS SHALL NOT BE ALTERED AND SHALL BE MAINTAINED BY THE LOT OWNER.

25) GOVERNMENTAL REGULATIONS. GRANTEES FURTHER AGREE THAT ANY USE OF IMPROVEMENTS MADE ON THIS LAND SHALL BE IN CONFORMITY WITH ALL EXISTING VALID ZONING, PLATTING, HEALTH, OR OTHER LAWFUL RULES AND REGULATIONS.

26) ANTENNAS. TELEVISION ANTENNAS WILL BE PERMITTED AS WILL SATELLITE DISHES NOT OVER 24 INCHES IN DIAMETER.

27) STORAGE TANKS. ALL PROPANE OR ANY OTHER TANKS STORING FUEL SHALL BE BURIED UNDERGROUND.

28) CLOTHES LINES. NO CLOTHING OR ANY OTHER HOUSEHOLD FABRICS SHALL BE HUNG IN THE OPEN ON ANY LOT, AND NO OUTSIDE CLOTHES DRYING OR AIRING FACILITIES SHALL BE PERMITTED ON ANY LOT.

29) WELLS. UNTIL SUCH TIME AS PUBLIC WATER SUPPLY IS AVAILABLE TO SERVE THIS SUBDIVISION, POTABLE WATER SHALL BE SUPPLIED FROM DUAL WELLS DRILLED FOR EACH DWELLING ERRECTED IN THE AREA IN ACCORDANCE WITH THE REQUIREMENTS OF THE COUNTY BOARD OF HEALTH.

30) SALE OF ALL LOTS. ONE YEAR AFTER THE SALE OF ALL OF THE LOTS IN MARELM MEADOWS BY THE PROPRIETOR, THE PHRASE "MAJORITY OF THE LOT OWNERS" WILL BE SUBSTITUTED FOR THE WORD "PROPRIETOR" IN THE ABOVE COVENANTS AND RESTRICTIONS. HOWEVER, ANY WRITTEN AGREEMENTS BY THE PROPRIETOR PRIOR TO THIS TIME WILL REMAIN IN EFFECT.

31) RESTRICTIONS TO RUN WITH LAND. THESE COVENANTS AND RESTRICTIONS ARE FOR THE BENEFIT OF ALL LOT OWNERS OF MARELM MEADOWS AND ARE TO RUN WITH THE LAND AND SHALL BE BINDING ON ALL PARTIES AND ALL PERSONS CLAIMING UNDER THEM UNLESS BY VOTE OF THE MAJORITY OF THE THEN OWNERS OF THE LOTS, IT IS AGREED TO CHANGE SAID COVENANTS IN WHOLE OR IN PART. ANY SUCH REVISION SHALL NOT TAKE EFFECT UNTIL PROPERLY FILED FOR RECORD WITH THE LOGAN COUNTY RECORDER.

32) ENFORCEMENT. THESE RESTRICTIONS SHALL BE FOR THE BENEFIT OF ALL OF THE LOT OWNERS OF MARELM MEADOWS AND THE PROPRIETOR HEREIN. ENFORCEMENT OF THESE RESTRICTIONS SHALL BE BY PROCEEDINGS AT LAW OR EQUITY AGAINST ANY PERSON OR PERSONS VIOLATING OR ATTEMPTING TO VIOLATE ANY RESTRICTION. EITHER TO RESTRAIN ANY VIOLATION OR TO RECOVER DAMAGES, INCLUDING ATTORNEY FEES AND COURT COSTS RESULTING FROM SAID VIOLATION, TOGETHER WITH ANY OTHER REMEDY PERMISSIBLE UNDER OHIO LAW.

33) SEVERABILITY. INVALIDATION OF ANY ONE OF THESE COVENANTS BY JUDGMENT OR COURT ORDER SHALL IN NO WAY AFFECT ANY OF THE OTHER PROVISIONS WHICH SHALL REMAIN IN FULL FORCE AND EFFECT.

34) DRAINAGE SYSTEM. THE DRAINAGE EASEMENTS, AND THE DRAINAGE INFRASTRUCTURE LOCATED WITHIN UTILITY EASEMENTS, AS INDICATED ON THE PLAT, SHALL BE FOR THE DETENTION AND TRANSPORT OF SURFACE AND STORM WATERS FROM THE DEVELOPMENT AND SHALL BE FOR THE BENEFIT OF ALL LOT OWNERS EXCEPT AS SET FORTH HEREINAFTER. THE DRAINAGE EASEMENTS, AND THE DRAINAGE INFRASTRUCTURE LOCATED WITHIN UTILITY EASEMENTS, AS INDICATED ON THE PLAT, INCLUDING SUBSURFACE TILE AND CURTAIN DRAIN OUTLETS, SHALL BE MAINTAINED BY THE OWNERS OF THE LOTS ON WHICH THEY ARE LOCATED. IN THE EVENT THAT LOGAN COUNTY, OHIO (THE "COUNTY"), AND/OR JEFFERSON TOWNSHIP, LOGAN COUNTY, OHIO (THE "TOWNSHIP"), AGREES TO ASSUME THE MAINTENANCE RESPONSIBILITIES FOR ALL OR A PORTION OF THE DRAINAGE EASEMENTS, AND THE DRAINAGE INFRASTRUCTURE LOCATED WITHIN UTILITY EASEMENTS, AS INDICATED ON THE PLAT (THE "ASSUMED PORTIONS"), THE OWNERS OF THE LOTS ON WHICH ANY OF THE ASSUMED PORTIONS ARE LOCATED SHALL NO LONGER BE RESPONSIBLE FOR MAINTAINING THE ASSUMED PORTIONS. THE MAINTENANCE OF ANY PORTIONS NOT ASSUMED SHALL REMAIN THE OBLIGATION AND RESPONSIBILITY OF THE OWNERS OF THE LOTS ON WHICH SUCH UNASSUMED PORTIONS ARE LOCATED. EACH OWNER HEREBY GRANTS EVERY OTHER OWNER IN THE DEVELOPMENT A RIGHT OF ENTRY UPON THE DRAINAGE EASEMENTS, AND UTILITY EASEMENTS (IF SUCH UTILITY EASEMENTS CONTAIN DRAINAGE INFRASTRUCTURE) LOCATED ON SUCH OWNER'S LOT TO INVESTIGATE AND IDENTIFY THE SOURCE OF ANY MALFUNCTION OF THE DRAINAGE SYSTEM IN THE DEVELOPMENT. FOR ANY ASSUMED PORTIONS OF THE DRAINAGE EASEMENTS, AND DRAINAGE INFRASTRUCTURE LOCATED WITHIN UTILITY EASEMENTS, THE RIGHT OF ENTRY GRANTED TO THE LOT OWNERS OF THE DEVELOPMENT IN THE PRECEDING SENTENCE SHALL NO LONGER APPLY. INSTEAD A RIGHT OF ENTRY SHALL BE GRANTED TO THE REPRESENTATIVES, EMPLOYEES AND AGENTS OF THE COUNTY AND/OR THE TOWNSHIP, FOR THE PURPOSE OF MAINTAINING THE DEVELOPMENT'S DRAINAGE SYSTEM.

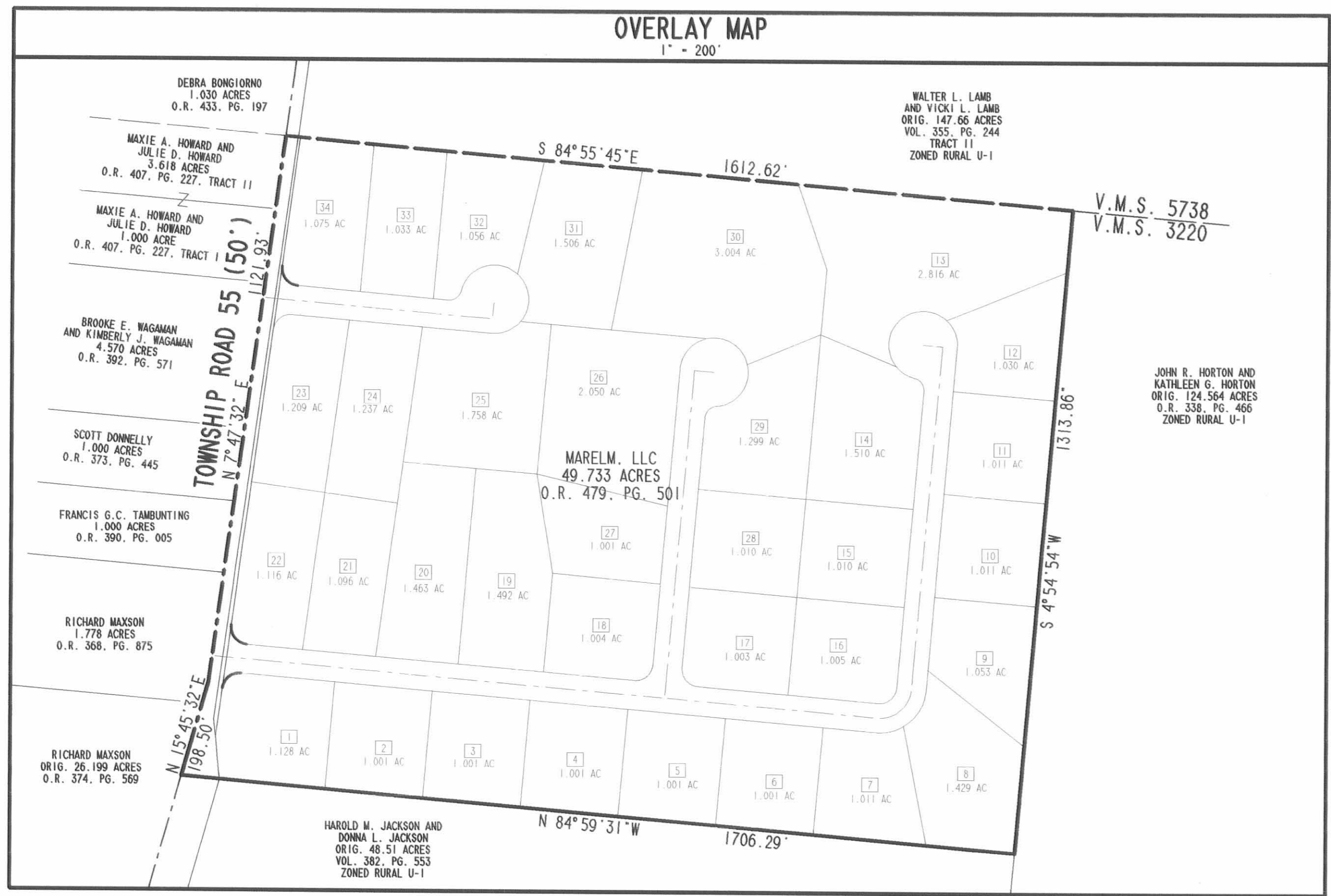

2 WORKING DAYS
BEFORE YOU DIG
CALL TOLL FREE 800-362-2764
OHIO UTILITIES PROTECTION SERVICE.

APRIL 28, 2000
COPYRIGHT 2000 BY:
LEE SURVEYING & MAPPING CO., INC.
117 North Madison Street
Bellefontaine, Ohio 43111
(937) 593-7336
D 360 BIBLPLTI
PRINT 1/17/2001
L-2830-1

J-303

J-303

Lee Surveying and Mapping Co., Inc.

Land Surveys • Topography • Subdivisions • Construction Layout

117 N. Madriver St.
Bellefontaine OH 43311



Phone: (937) 593-7335
Fax: (937) 593-7444

BIBLE 49.733 ACRES

LYING IN VIRGINIA MILITARY SURVEY 3220 , JEFFERSON TOWNSHIP, LOGAN COUNTY, OHIO

BEING ALL OF THE ELMER D. BIBLE AND MARGUERITE LOUISE KLEINOEDER ORIGINAL 50.0 ACRE TRACT AS DEEDED IN OFFICIAL RECORD 338, PAGE 469, TRACT II OF THE LOGAN COUNTY RECORDS OF DEEDS AND BEING MORE PARTICULARLY DESCRIBED AS FOLLOWS:

BEGINNING AT A STONE FOUND AT THE INTERSECTION OF THE CENTER-LINE OF TOWNSHIP ROAD 55 AND THE NORTH LINE OF VIRGINIA MILITARY SURVEY 3220.

THENCE, WITH THE NORTH LINE OF VIRGINIA MILITARY SURVEY 3220 AND THE SOUTH LINE OF THE WALTER L. LAMP ORIGINAL 147.66 ACRE TRACT (O.R. 355, PAGE 244, TRACT II), S 84°55'45" E, A DISTANCE OF 1612.62 FEET TO A 5/8 INCH IRON ROD FOUND, PASSING A 5/8 INCH IRON ROD SET AT 30.03 FEET.

THENCE, WITH THE WEST LINE OF THE JOHN R. HORTON ORIGINAL 124.564 ACRE TRACT (O.R. 338, PG. 466) S 4°-54'-54" W, A DISTANCE OF 1313.86 FEET TO A 6 INCH WOOD POST FOUND.

THENCE, WITH THE NORTH LINE OF THE HAROLD M. JACKSON ORIGINAL 48.51 ACRE TRACT (VOL. 382, PAGE 553), N 84°-59'-31" W, A DISTANCE OF 1706.29 FEET TO A MAG NAIL SET, PASSING A 5/8 INCH IRON ROD SET AT 1628.47 FEET.

THENCE, WITH THE CENTER-LINE OF TOWNSHIP ROAD 55 (50 FEET WIDE), N 15°-45'-32" E, A DISTANCE OF 198.50 FEET TO A STONE FOUND.

THENCE, CONTINUING WITH THE CENTER-LINE OF TOWNSHIP ROAD 55, N 7°-47'-32" E, A DISTANCE OF 1121.93 FEET TO THE POINT OF BEGINNING.

CONTAINING 49.733 ACRES, OF WHICH 0.989 ACRE IS WITHIN THE HIGHWAY RIGHT-OF-WAY.

THE BASIS FOR BEARINGS IS THE NORTH LINE OF VIRGINIA MILITARY SURVEY 3220, BEING S 84°-55'-45" E, AND ALL OTHER BEARINGS ARE FROM ANGLES AND DISTANCES MEASURED IN A FIELD SURVEY BY LEE SURVEYING AND MAPPING CO., INC. ON JANUARY 28, 2000.

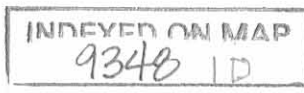

A handwritten signature in black ink, followed by the date '1-28-00' written in the same ink.

WALTER L. LAMB AND VICKI L. LAMB
ORIG. 147.66 AC.
VOL. 355, PG. 244, TRACT 11

VIRGINIA MILITARY SURVEY 5738
VIRGINIA MILITARY SURVEY 3220

JOHN R. HORTON AND KATHLEEN G. HORTON
ORIG. 124.564 ACRES
O.R. 338, PG. 466

ELMER D. BIBLE AND MARGUERITE LOUISE KLEINOEDER
ORIG. 50.0 ACRE TRACT
(49.733 AC. BY THIS SURVEY)
OF WHICH 0.989 ACRE IS WITHIN THE ROAD RIGHT-OF-WAY
O.R. 338, PG. 469, TRACT 11

HAROLD M. JACKSON AND DONNA L. JACKSON
ORIG. 48.51 ACRES
VOL. 382, PG. 553

RETRACEMENT SURVEY OF THE
ELMER D. BIBLE AND MARGUERITE LOUISE KLEINOEDER
ORIGINAL 50.0 ACRE TRACT (49.733 ACRES BY THIS SURVEY)
OFFICIAL RECORD 338, PAGE 469, TRACT 11
VIRGINIA MILITARY SURVEY 3220
JEFFERSON TOWNSHIP
LOGAN COUNTY, OHIO

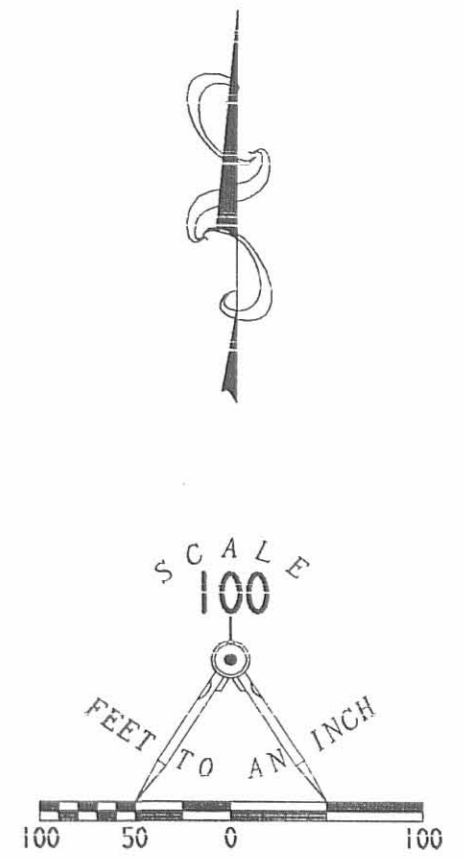

LEGEND

- 5/8" INCH IRON ROD SET W/ PLASTIC I.D. CAP STAMPED "LEE F56359"
- 5/8 INCH IRON ROD FOUND
- ⊕ MAG NAIL SET
- ⊠ STONE FOUND
- ⊙ 6" WOOD POST FOUND



Jeffrey I. Lee
JEFFREY I. LEE
PROFESSIONAL SURVEYOR 6359
JANUARY 28, 2000

COPYRIGHT 2000 BY:
LEE SURVEYING & MAPPING CO., INC.
117 North Madriver Street
BELLEFONTAINE, OHIO 43311
(937) 593-7335
D 360 BIBLND L-2830-2
G-680

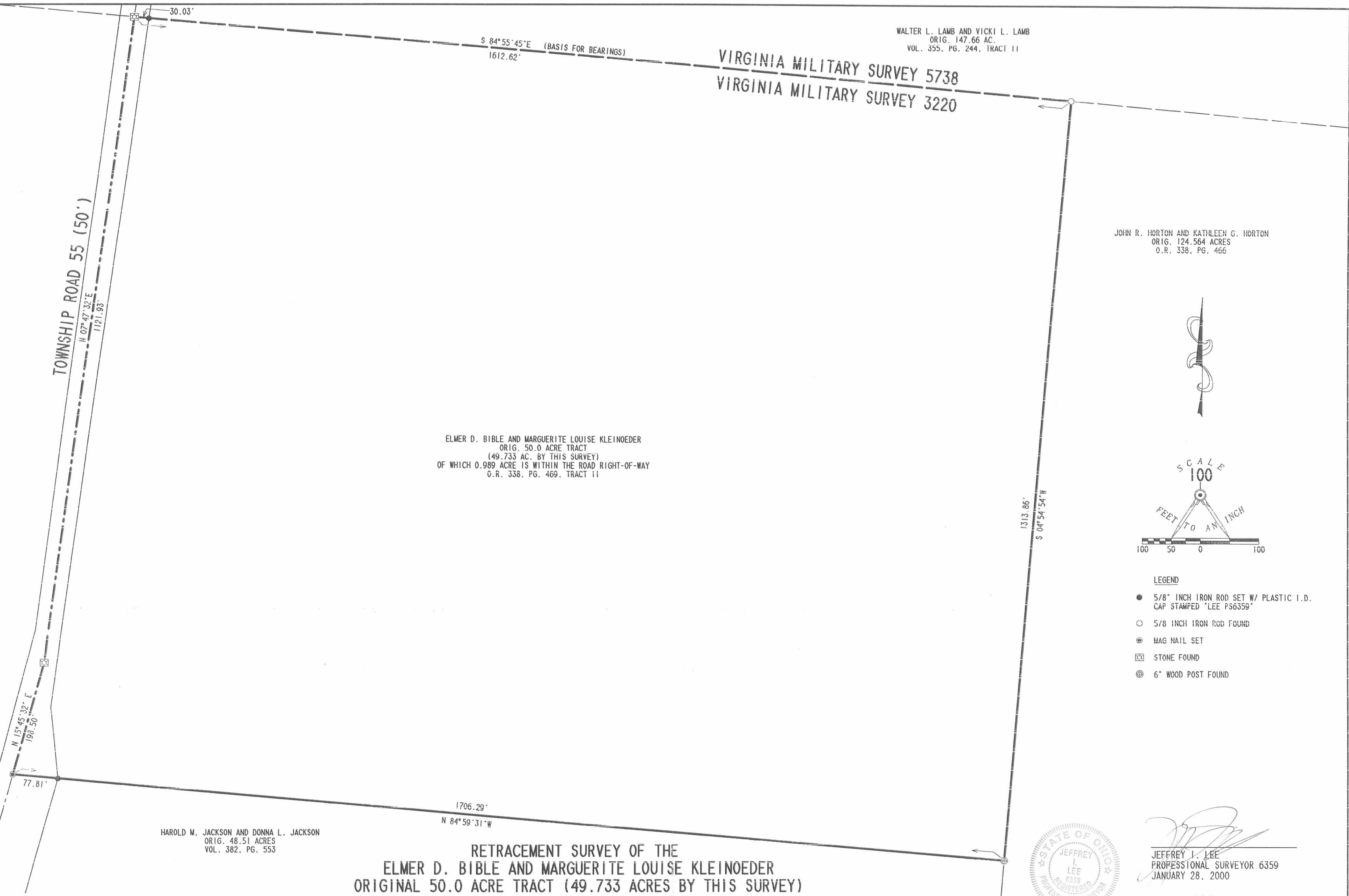

2 WORKING DAYS
BEFORE YOU DIG
CALL TOLL FREE 800-362-2764
OHIO UTILITIES PROTECTION SERVICE.

INDEXED ON MAP
9348 IP

2-12-2020



APPROVED

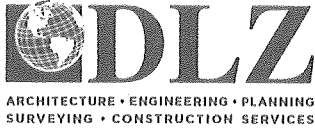

INNOVATIVE IDEAS
EXCEPTIONAL DESIGN
UNMATCHED CLIENT SERVICE

ROBINSON LAND DEVELOPMENT LLC

19.034 ACRES

Lying in Virginia Military Survey 3220, Jefferson Township, Logan County, Ohio (all records referenced herein refer to the Logan County Records of Deeds).

Being all of vacated Lots 23 through 34 as deeded and described in Official Record 1368, Page 617 and that part of vacated Bluegrass Street (60 feet wide) and all of vacated Marelm Lane (60 feet wide) of Marelm Meadows Subdivision (Plat Cabinet B, Slides 59B and 60A) as vacated by Logan County Resolution No. 336-19 and deeded and described in Official Record 1368, Page 614 and being more particularly described as follows:

BEGINNING at a 5/8 inch iron rod found at the northwest corner of Lot 22 of said Marelm Meadows Subdivision and southwest corner of said vacated Lot 23;

THENCE, with the westerly lines of said vacated Lot 23, vacated Marelm Lane and vacated Lot 34 and the easterly right-of-way line of Township Road 55 (55 feet wide), **N 07°-44'-31" E**, a distance of **709.11 feet** to a 5/8 inch iron rod found at the northwest corner of vacated Lot 34 and in the south line of the CMR Land, LLC, 437.147 acre tract as deeded and described in Official Record 927, Page 811, also being on the north line of Virginia Military Survey 3220 and the south line of Virginia Military 5738;

THENCE, with the northerly lines of said vacated Lots 34, 33, 32, 31 and 30 and Virginia Military Survey 3220 and the southerly lines of said 437.147 acre tract and Virginia Military Survey 5738, **S 84°-58'-36" E**, a distance of **1020.00 feet** to a point in an underground electric box, being at the northerly corner common to said vacated Lot 30 and Lot 13 of said Subdivision;

INDEXED ON MAP
9348

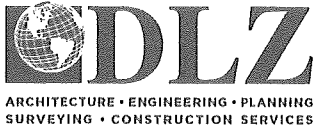

INNOVATIVE IDEAS
EXCEPTIONAL DESIGN
UNMATCHED CLIENT SERVICE

THENCE, with a common line to said vacated Lot 30 and said Lot 13, **S 19°-04'-38" E**, a distance of **180.25 feet** to a 5/8 inch iron rod found (I.D. cap stamped "LEE PS 6359");

THENCE, with the easterly lines of said vacated Lots 30, 29 and 28 and the westerly lines of said Lot 13 and Lots 14 and 15 of said Subdivision, **S 04°-55'-42" W**, a distance of **671.67 feet** to a 5/8 inch iron rod found (I.D. cap stamped "LEE PS 6359") at the common northerly corner to Lot 16 & 17 of said Subdivision;

THENCE, with the southerly lines of said vacated Lot 28 and 27 and vacated Bluegrass Street (60 feet wide) and the northerly lines of said Lot 17 and Lot 18 of said Subdivision, **N 85°-10'-19" W**, passing 5/8 inch iron rods found at distances of 219.99 feet and 279.97 feet, a total distance of **500.00 feet** to a point in an underground electric box, referenced by a 5/8 inch iron rod found bearing **S 17°-23'-59" W**, a distance of 6.17 feet, said point being a corner common to said vacated Lot 27 and said Lot 18 and Lot 19 of said Subdivision;

THENCE, with a line common to said vacated Lot 27 and said Lot 19, **N 09°-07'-58" W**, a distance of **207.23 feet** to a 5/8 inch iron rod found at a corner common to said Lot 19 and vacated Lots 26 and 25;

THENCE, with the southerly line of said vacated Lot 25 and the northerly lines of said Lot 19 and Lot 20 of said Subdivision, **N 85°-07'-37" W**, a distance of **274.26 feet** to a 5/8 inch iron rod found (I.D. cap stamped "LEE PS 6359"), being the southwest corner of said vacated Lot 25, northwest corner of said Lot 20 and on the easterly line of said vacated Lot 24;

THENCE, with a line common to said vacated Lot 24 and said Lot 20, **S 07°-40'-47" W**, a distance of **84.99 feet** to a 5/8 inch iron rod found (I.D. cap stamped "LEE PS 6359") at the northeast corner of Lot 21 of said Subdivision;

INDEXED ON MAP
9348



INNOVATIVE IDEAS
EXCEPTIONAL DESIGN
UNMATCHED CLIENT SERVICE

THENCE, with the southerly lines of said vacated Lots 24 and 23 and the northerly lines of said Lots 21 and 22, **N 82°-14'-40" W**, a distance of **299.81 feet** to the **POINT OF BEGINNING**.

Containing **19.034 acres**, more or less.

Property is subject to any and all previous easements and rights-of-way of record.

Bearings and distances, described herein, are derived from GPS observations based on Grid North, Ohio State Plane Coordinate System, North Zone, NAD83 (2011, Epoch 2010), with the north line of Virginia Military Survey 3220, having a bearing of S 84°-58'36" E. Distances are expressed in U.S. Survey Feet. All other measurements are from angles and distances measured in a field survey by DLZ on August 15, 2019.

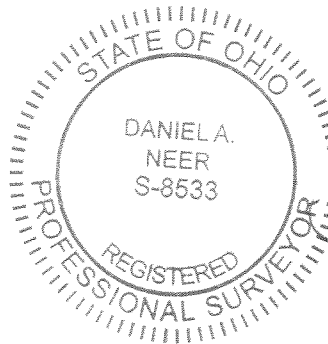

Description prepared by:

Daniel A. Neer
Daniel A. Neer

Professional Surveyor No. 8533

February 10, 2020

1921-2016.00



2-12-2020



DEED & SURVEY REFERENCES:

REFERENCE DEEDS ARE SHOWN HEREON

MARELM MEADOWS SUBDIVISION
PLAT CABINET B, SLIDES 59B AND 60A

LOGAN COUNTY ENGINEER'S MAP ROOM
FILE: 9348

OCCUPATION NOTE:

NO EVIDENCE OF OCCUPATION ALONG
BOUNDARY LINES UNLESS OTHERWISE SHOWN

BASIS FOR BEARINGS:

BEARINGS AND DISTANCES, SHOWN HEREON,
ARE DERIVED FROM GPS OBSERVATIONS
BASED ON GRID NORTH, OHIO STATE PLANE
COORDINATE SYSTEM, NORTH ZONE, NAD83
(2011, EPOCH 2010), WITH THE NORTH LINE
OF VIRGINIA MILITARY SURVEY 3220, HAVING
A BEARING OF S 84°58'36" E.

THIS SURVEY WAS PREPARED IN THE
ABSENCE OF A COMPLETE AND ACCURATE
TITLE SEARCH AND DOES NOT GUARANTEE
TITLE.

CMR LAND, LLC
437.147 ACRES
O.R. 927, PG. 811

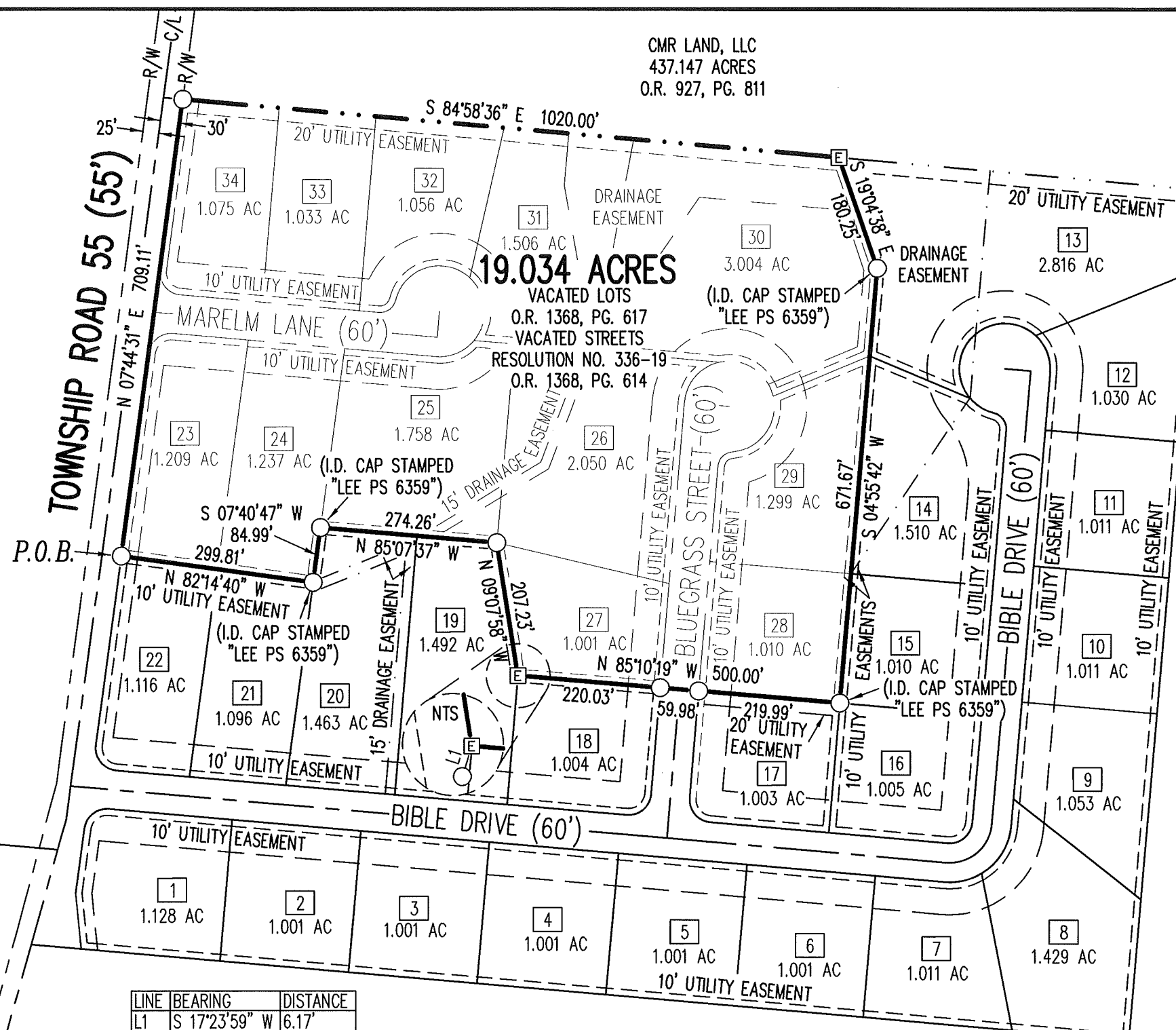

V.M.S. 5738
V.M.S. 3220

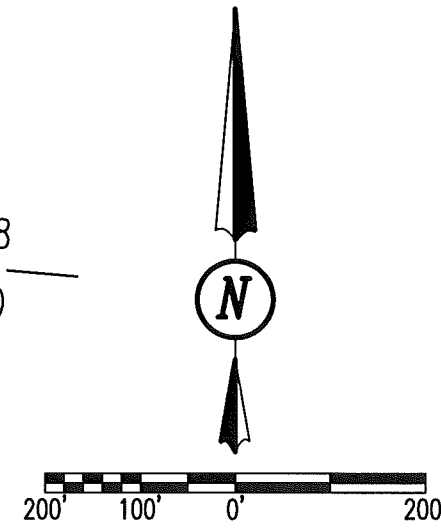

SCALE: 1" = 200'
DISTANCES SHOWN HEREON
ARE IN U.S. SURVEY FEET

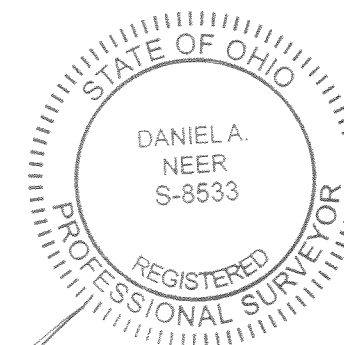

Daniel A. Neer
DANIEL A. NEER
PROFESSIONAL SURVEYOR NO. 8533
AUGUST 15, 2019

LINE	BEARING	DISTANCE
L1	S 17°23'59" W	6.17'

LEGEND

- 5/8 INCH IRON ROD FOUND
- ⊞ UNDERGROUND ELECTRIC BOX
- P.O.B. = POINT OF BEGINNING
- R/W = RIGHT-OF-WAY
- C/L = CENTER-LINE
- NTS = NOT TO SCALE
- V.M.S. = VIRGINIA MILITARY SURVEY

BOUNDARY SURVEY

FOR VACATED LOTS 23-34 AND VACATED MARELM
LANE AND PART OF BLUEGRASS STREET
MARELM MEADOWS SUBDIVISION
PLAT CABINET B, SLIDES 59b & 60A
VIRGINIA MILITARY SURVEY 3220
JEFFERSON TOWNSHIP
LOGAN COUNTY, OHIO

DRAWN BY:	DESCRIPTION	REV. NO.	DATE
KSS			2/10/2020

COPYRIGHT 2019 BY:

117 N. Madriver Street • Bellefontaine, OH 43311
(937) 593-7335 • www.dlz.com
Project #1921-2016.00

INDEXED ON MAP
9348

APPROVED

SURVEY FOR ROBINSON LAND DEVELOPMENT LLC
3.000 Acres
November 20, 2023

The following described 3.000 acre tract of land is situated in the State of Ohio, County of Logan, Township of Jefferson, and V.M.S. 3220, being all of Robinson Land Development LLC's Lot 17 in Marelm Meadows Subdivision (recorded in Plat Cabinet B, on Slide 59B) described in O.R. 1202, Pg. 239, part of Robinson Land Development LLC's 19.034 acre tract (all of vacated Lot 28 and part of vacated Lot 29 as described in O.R. 1368, Pg. 617, and part of vacated Bluegrass Street (60')(reference Resolution No. 336-19 and described in O.R. 1368, Pg. 614), said 19.034 acre tract described in O.R. 1408, Pg. 2725), and part of said vacated Bluegrass Street between said Lot 17 and Lot 18 in said Subdivision, and said 3.000 acre tract being more particularly described as follows:

Beginning at a 5/8 inch iron pin found at the southeast corner of said Lot 17, at the southwest corner of Lot 16 in said Subdivision, and in the north line of Bible Drive;

Thence **North 85°00'13" West 249.98 feet**, following the north line of Bible Drive and the south line of said Lot 17, passing at 185.04 feet a 5/8 inch iron pin found at the southwest corner of Lot 17 and at the southeast corner of said vacated Bluegrass Street, thereafter following the south end of said vacated Street, to an iron pin set;

Thence **North 4°53'46" East 522.51 feet**, departing from the north line of Bible Drive and following the centerline of said vacated Bluegrass Street, passing at 200.24 feet a point in the south line of said 19.034 acre tract, thereafter entering said 19.034 acre tract, to an iron pin set;

Thence **South 85°06'14" East 249.98 feet**, to an iron pin set in the west line of Valerie Elliott's Lot 14 in said Subdivision and recorded in O.R. 1199, Pg. 159;

Thence **South 4°53'46" West 522.95 feet**, following the east line of said 19.034 acre tract, the west line of said Lot 14, and the west line of Aaron and Sierra Myers Lot 15 in said Subdivision and recorded in O.R. 1406, Pg. 541, passing at 323.08 feet a 5/8 inch iron pin found with cap marked "LEE PS 6358" at the northwest corner of Mark W. and Tami L. Himmeger's Lot 16 in said Subdivision and recorded in O.R. 1329, Pg. 947, thereafter following the west line of said Lot 16 and the east line of said Lot 17, to the **place of beginning, containing 3.000 acres**, more or less, and being subject to all valid easements and restrictions of record.

Of the above described 3.000 acre tract, 1.003 acre is all said Lot 17, 1.854 acre is part of said 19.034 acre tract, and 0.143 acre is the east half of said vacated Bluegrass Street not included in said 19.034 acre tract and between Lot 17 and Lot 18.

The above description was prepared from an actual field survey made under the supervision of Paul R. Clapsaddle, Registered Surveyor 6140, during the month of November 2023. Bearings indicated herein are based on State Plane Coordinate North Zone, NAD 83 and GPS observations. Iron pins set are 5/8 inch by 30 inch reinforcing rods with caps marked "CLAPSADDLE RS 6140".

ATTEST: Paul R. Clapsaddle

Paul R. Clapsaddle, R.S. 6140
19019 West Darby Road
Marysville, Ohio 43040
(937) 248-1065

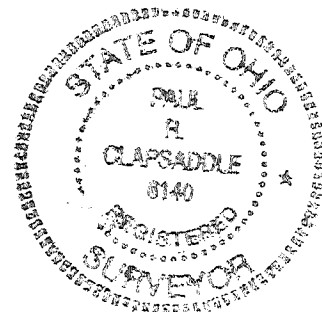

INDEXED ON MAP
9348

APPROVED

PLAT OF SURVEY FOR ROBINSON LAND DEVELOPMENT LLC

STATE OF OHIO
COUNTY OF LOGAN
TOWNSHIP OF JEFFERSON
V.M.S. 3220

NOTES:

Reference deeds are shown hereon.

Bearings indicated hereon are based on State Plane Coordinates North Zone, NAD 83, and GPS observations.

SURVEY REFERENCES:

DLZ survey, Log. Co. Survey 9348

Marelm Meadows Subdivision plat
Plat Cabinet B, Slide 59B

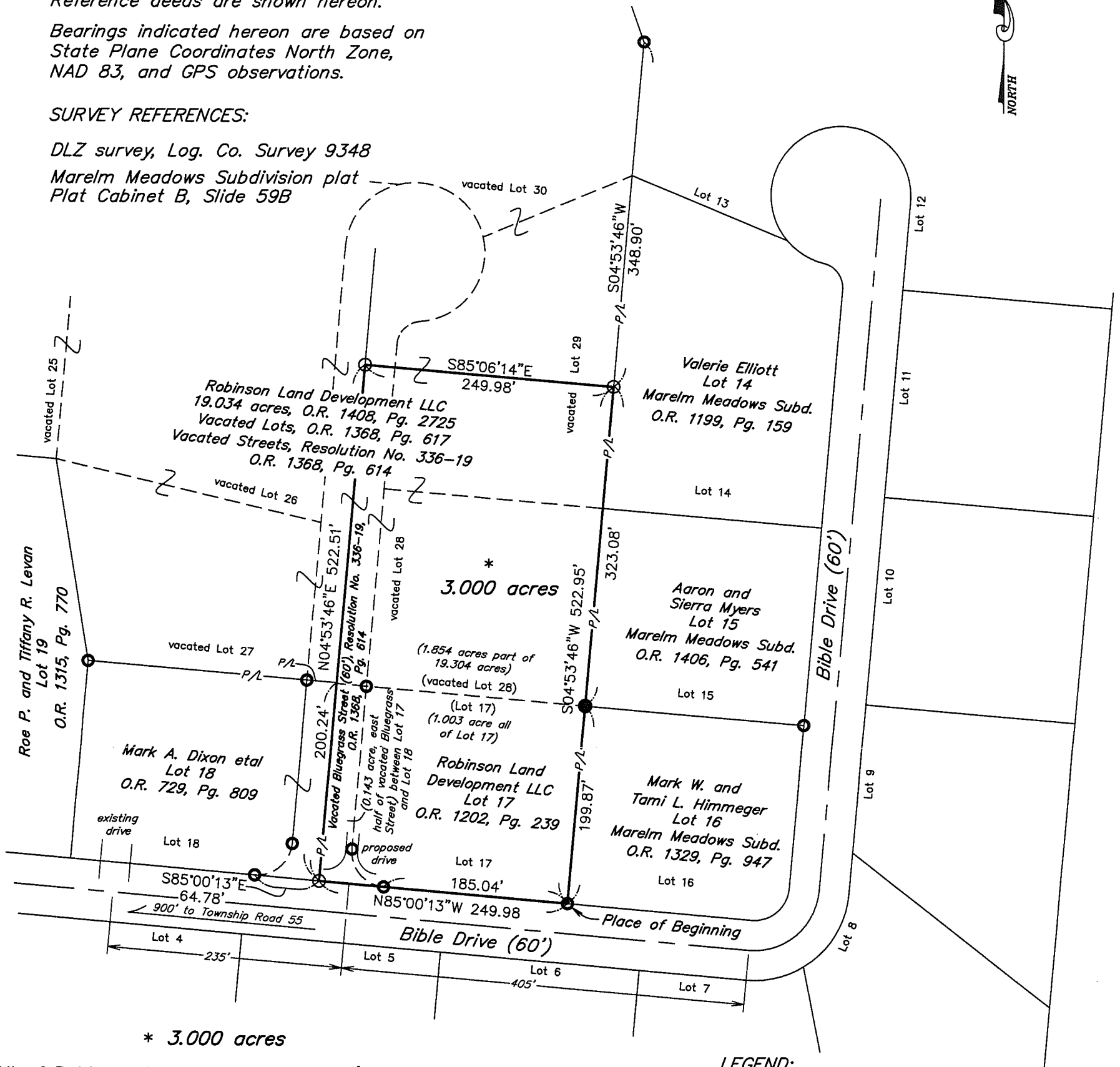

* 3.000 acres

All of Robinson Land Development LLC's Lot 17 in Marelm Meadows Subdivision (recorded in Plat Cabinet B, on Slide 59B) described in O.R. 1202, Pg. 239, part of Robinson Land Development LLC's 19.034 acre tract (all of vacated Lot 28 and part of vacated Lot 29 as described in O.R. 1368, Pg. 617, part of vacated Bluegrass Street (60')(reference No. 336-19 and recorded in O.R. 1368, Pg. 614), said 19.034 acre tract described in O.R. 1408, Pg. 2725), and part of said vacated Bluegrass Street between said Lot 17 and Lot 18 in said Subdivision

LEGEND:

- 5/8 inch iron pin found
- 5/8 inch iron pin found with cap marked "LEE PS 6358"
- 5/8 inch iron pin set with cap marked "CLAPSADDLE RS 6140"



Date: Nov. 20, 2023
Scale: 1"=120'

Project: RobinsonMMS_Aug23
Drawing: RobinsonMMS_Aug23

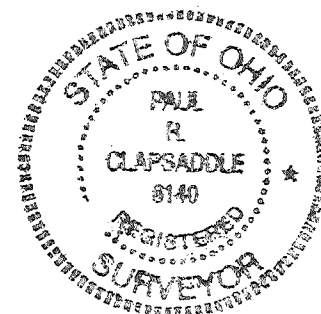

Paul R. Clapsaddle and Associates
REGISTERED ENGINEERS AND SURVEYORS
19019 WEST DARBY ROAD, MARYSVILLE OHIO 43040
(937) 248-1065
Paul R. Clapsaddle, P.E., P.S.

I hereby certify that this plat was prepared from a field survey made under my supervision and that monuments were placed as indicated hereon.

Paul R. Clapsaddle
Paul R. Clapsaddle, R.S. 6140

INDEXED ON MAP
9348