

REC'D 1-28-04 SUM

Lee Surveying and Mapping Co., Inc.

Land Surveys • Topography • Subdivisions • Construction Layout

117 N. Madriver St.
Bellefontaine OH 43311



Phone: (937) 593-7335
Fax: (937) 593-7444

TRACT A-1 5.631 ACRES

Lying in Virginia Military Survey 4493-4525, Monroe Township, Logan County, Ohio.

Being out of the Countrytyme Grove City Ltd. 53.602 acre tract as deeded and described on Official Record 691, Page 702 of the Logan County Records of Deeds and being more particularly described as follows:

Beginning at a 3/4 inch iron rod found in a monument box at the intersection of center-lines of County Highway 5 (60 feet wide) and Township Road 165 (60 feet wide).

THENCE, with the center-line of County Highway 5, N 18°-24'-41"E, a distance of 142.79 feet to a MAG nail found.

THENCE, with the north line of the Neil D. Yoder and Diane Sue Yoder 65.595 acre tract (O.R. 520, Pg. 465), N 40°-36'-09"W, a distance of 944.84 feet to a 5/8 inch iron rod set at the TRUE POINT OF BEGINNING, passing a 5/8 inch iron rod found at 34.78 feet.

THENCE, with the north line of the said 65.595 acre tract and the north line of the Jessalyn I. Strayer original 58.554 acre tract (O.R. 178, Pg. 463 Parcel Two), N 40°-36'-09"W, a distance of 1054.30 feet to a 5/8 inch iron rod set.

THENCE, S 71°-35'-19"E, a distance of 903.85 feet to a 5/8 inch iron rod set.

THENCE, S 18°-24'-41"W, a distance of 542.79 feet to the point of beginning, passing a 5/8 inch iron rod set at 270.00 feet.

Containing 5.631 acres.

The basis for bearings is the center-line of County Highway 5 being S 18°-24'-41"W, and all other bearings are from angles and distances measured in a field survey by Lee Surveying and Mapping Co., Inc. on December 19, 2003.

Description prepared by:



ORIGINAL STAMP IN GREEN

Jeffrey I. Lee
Jeffrey I. Lee
Professional Surveyor 6359
January 20, 2003

L-3441

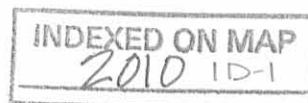

REC'D 1-28-04 SML/OK

Lee Surveying and Mapping Co., Inc.

Land Surveys • Topography • Subdivisions • Construction Layout

117 N. Madriver St.
Bellefontaine OH 43311



Phone: (937) 593-7335
Fax: (937) 593-7444

TRACT B-2 5.493 ACRES

Lying in Virginia Military Survey 4493-4525, Monroe Township, Logan County, Ohio.

Being out of the Countrytyme Grove City Ltd. 53.602 acre tract as deeded and described on Official Record 691, Page 702 of the Logan County Records of Deeds and being more particularly described as follows:

Beginning at a 3/4 inch iron rod found in a monument box at the intersection of center-lines of County Highway 5 (60 feet wide) and Township Road 165 (60 feet wide).

THENCE, with the center-line of County Highway 5, N 18°-24'-41"E, a distance of 142.79 feet to a MAG nail found.

THENCE, with the north line of the Neil D. Yoder and Diane Sue Yoder 65.595 acre tract (O.R. 520, Pg. 465), N 40°-36'-09"W, a distance of 944.84 feet to a 5/8 inch iron rod set, passing a 5/8 inch rod found at 34.78 feet.

THENCE, N 18°-24'-41"E, a distance of 542.79 feet to a 5/8 inch iron rod set at THE TRUE POINT OF BEGINNING.

THENCE, N 71°-35'-19"W, a distance of 903.85 feet to a 5/8 inch iron rod set.

THENCE, N 40°-36'-09"W, a distance of 104.25 feet to a railroad tie post found.

THENCE, with the south line of Virginia Military Survey 10583 and the Kevin J. Forrest and Peggy J. Forrest 35.28 acre tract (O.R. 153, Pg.612), N 66°-58'-21"E, a distance of 326.87 feet to a 5/8 inch iron rod set.

THENCE, S 71°-35'-19"E, a distance of 748.18 feet to a 5/8 inch iron rod set.

THENCE, S 18°-24'-41"W, a distance of 270.00 feet to the point of beginning.

Containing 5.493 acres.

The basis for bearings is the center-line of County Highway 5 being S 18°-24'-41"W, and all other bearings are from angles and distances measured in a field survey by Lee Surveying and Mapping Co., Inc. on December 19, 2003.

Description prepared by:



ORIGINAL STAMP IN GREEN

Jeffrey I. Lee
Jeffrey I. Lee
Professional Surveyor 6359
January 20, 2003

L-3441



REV'D 1-28-04 SML/OK
Lee Surveying and Mapping Co., Inc.

Land Surveys • Topography • Subdivisions • Construction Layout

117 N. Madriver St.
Bellefontaine OH 43311



Phone: (937) 593-7335
Fax: (937) 593-7444

**TRACT CD-12
5.484 ACRES**

Lying in Virginia Military Survey 4493-4525, Monroe Township, Logan County, Ohio.

Being out of the Countrytyme Grove City Ltd. 53.602 acre tract as deeded and described on Official Record 691, Page 702 of the Logan County Records of Deeds and being more particularly described as follows:

Beginning at a 3/4 inch iron rod found in a monument box at the intersection of center-lines of County Highway 5 (60 feet wide) and Township Road 165 (60 feet wide).

THENCE, with the center-line of County Highway 5, N 18°-24'-41"E, a distance of 142.79 feet to a MAG nail found.

THENCE, with the north line of the Neil D. Yoder and Diane Sue Yoder 65.595 acre tract (O.R. 520, Pg. 465), N 40°-36'-09"W, a distance of 944.84 feet to a 5/8 inch iron rod set, passing a 5/8 inch iron rod found at 34.78 feet.

THENCE, N 18°-24'-41"E, a distance of 812.79 feet to a 5/8 inch iron rod set at THE TRUE POINT OF BEGINNING.

THENCE, N 71°-35'-19"W, a distance 748.18 feet to a 5/8 inch iron rod set.

THENCE, with the south lines of Virginia Military Survey 10853, Virginia Military Survey 12099 and the Kevin J. Forrest and Peggy J. Forrest 35.28 acre tract (O.R. 153, Pg.612) and the Thomas W. Godwin and C. Joan Godwin original 189.963 acre tract (O.R. 92, Pg. 145), N 66°-58'-21"E, a distance of 815.92 feet to a point, passing a 5/8 inch iron rod set at 407.96 feet.

THENCE, S 71°-35'-19"E, a distance of 136.51 feet to a 5/8 inch iron rod set, passing a 5/8 inch iron rod set at a distance of 7.72 feet.

THENCE, S 18°-24'-41"W, a distance of 540.00 feet to the point of beginning.

Containing 5.484 acres.

The basis for bearings is the center-line of County Highway 5 being S 18°-24'-41"W, and all other bearings are from angles and distances measured in a field survey by Lee Surveying and Mapping Co., Inc. on December 19, 2003.



ORIGINAL STAMP IN GREEN

Description prepared by:

A handwritten signature in black ink, appearing to read 'J. Lee'.

Jeffrey I. Lee
Professional Surveyor 6359
January 20, 2003

L-3441

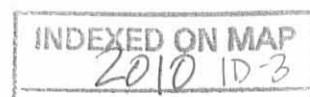

REC'D 1-28-04 SML/OK
Lee Surveying and Mapping Co., Inc.

Land Surveys • Topography • Subdivisions • Construction Layout

117 N. Madriver St.
Bellefontaine OH 43311



Phone: (937) 593-7335
Fax: (937) 593-7444

**TRACT E-5
1.946 ACRES**

Lying in Virginia Military Survey 4493-4525, Monroe Township, Logan County, Ohio.

Being out of the Countrytyme Grove City Ltd. 53.602 acre tract as deeded and described on Official Record 691, Page 702 of the Logan County Records of Deeds and being more particularly described as follows:

Beginning at a 3/4 inch iron rod found in a monument box at the intersection of center-lines of County Highway 5 (60 feet wide) and Township Road 165 (60 feet wide).

THENCE, with the center-line of County Highway 5, N 18°-24'-41"E, a distance of 2252.01 feet to a MAG nail found.

THENCE, with the south line of the John M. Kauffman 1.256 acre tract (O.R. 623, Pg. 526), N 65°-27'-21"W, a distance of 158.28 feet to a 5/8 inch iron rod found at THE TRUE POINT OF BEGINNING, passing a 5/8 inch iron rod found at 30.17 feet.

THENCE, N 65°-27'-21"W, a distance of 416.17 feet to a 5/8 inch iron rod set.

THENCE, with the south line of Virginia Military Survey 12099 and the Thomas W. Godwin and C. Joan Godwin original 189.963 acre tract (O.R. 92, Pg. 145), N 66°-58'-21"E, a distance of 551.84 feet to a 5/8 inch iron rod found.

THENCE, with the west line of the said 1.256 acre tract, S 18°-23'-55"W, a distance of 409.68 feet to the point of beginning.

Containing 1.946 acres.

The basis for bearings is the center-line of County Highway 5 being S 18°-24'-41"W, and all other bearings are from angles and distances measured in a field survey by Lee Surveying and Mapping Co., Inc. on December 19, 2003.

Description prepared by:



ORIGINAL STAMP IN GREEN

A handwritten signature in black ink, appearing to read 'Jeffrey I. Lee'.

Jeffrey I. Lee
Professional Surveyor 6359
January 20, 2003

L-3441



REVID 1-28-04 SMM OK
Lee Surveying and Mapping Co., Inc.

Land Surveys • Topography • Subdivisions • Construction Layout

117 N. Madriver St.
Bellefontaine OH 43311



Phone: (937) 593-7335
Fax: (937) 593-7444

**TRACT F-6
5.370 ACRES**

Lying in Virginia Military Survey 4493-4525, Monroe Township, Logan County, Ohio.

Being out of the Countrytyme Grove City Ltd. 53.602 acre tract as deeded and described on Official Record 691, Page 702 of the Logan County Records of Deeds and being more particularly described as follows:

Beginning at a 3/4 inch iron rod found in a monument box at the intersection center-lines of County Highway 5 (60 feet wide) and Township Road 165 (60 feet wide).

THENCE, with the center-line of County Highway 5, N 18°-24'-41"E, a distance of 1982.01 feet to a MAG nail set at THE TRUE POINT OF BEGINNING.

THENCE, N 71°-35'-19"W, a distance of 946.51 feet to a point, passing 5/8 inch iron rod set at 30.00 feet and 938.79 feet.

THENCE, with the south line of Virginia Military Survey 12099 and Thomas W. Godwin and C. Joan Godwin original 189.963 acre tract (O.R. 92, Pg. 145), N 66°-58'-21"E, a distance of 500.69 feet to a 5/8 inch iron rod set.

THENCE, with the south line extended of the John M. Kauffman 1.256 acre tract (O.R. 623, Pg. 526) and said south line, S 65°-27'-21"E, a distance of 574.45 feet to a MAG nail found, passing a 5/8 inch iron rod found at 416.17 feet and 544.28 feet.

THENCE, with the center-line of County Highway 5, S 18°-24'-41"W, a distance of 270.00 feet to the point of beginning.

Containing 5.370 acres of which 0.187 acre is within the highway right-of-way.

The basis for bearings is the center-line of County Highway 5 being S 18°-24'-41"W, and all other bearings are from angles and distances measured in a field survey by Lee Surveying and Mapping Co., Inc. on December 19, 2003.

Description prepared by:



ORIGINAL STAMP IN GREEN

A handwritten signature in black ink, appearing to read 'J. Lee', written over the typed name and title.
Jeffrey I. Lee
Professional Surveyor 6359
January 20, 2003

L-3441

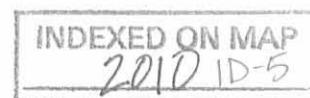

REC'D 1-28-04 SMJ/OK
Lee Surveying and Mapping Co., Inc.

Land Surveys • Topography • Subdivisions • Construction Layout

117 N. Madriver St.
Bellefontaine OH 43311



Phone: (937) 593-7335
Fax: (937) 593-7444

**TRACT G-7
5.021 ACRES**

Lying in Virginia Military Survey 4493-4525, Monroe Township, Logan County, Ohio.

Being out of the Countrytyme Grove City Ltd. 53.602 acre tract as deeded and described on Official Record 691, Page 702 of the Logan County Records of Deeds and being more particularly described as follows:

Beginning at a 3/4 inch iron rod found in a monument box at the intersection center-lines of County Highway 5 (60 feet wide) and Township Road 165 (60 feet wide).

THENCE, with the center-line of County Highway 5, N 18°-24'-41"E, a distance 1712.01 feet to a MAG nail set at THE TRUE POINT OF BEGINNING.

THENCE, N 71°-35'-19"W, a distance of 810.00 feet to a 5/8 inch iron rod set, passing a 5/8 inch iron rod set at 30.00 feet.

THENCE, N 18°-24'-41"E, a distance of 270.00 feet to a 5/8 inch iron rod set.

THENCE, S 71°-35'-19"E, a distance of 810.00 feet to a MAG nail set, passing a 5/8 inch iron rod set at 780.00 feet.

THENCE, with the center-line of County Highway 5, S 18°-24'-41"W, a distance of 270.00 feet to the point of beginning.

Containing 5.021 acres of which 0.186 acre is within the highway right-of-way.

The basis for bearings is the center-line of County Highway 5 being S 18°-24'-41"W, and all other bearings are from angles and distances measured in a field survey by Lee Surveying and Mapping Co., Inc. on December 19, 2003.

Description prepared by:



ORIGINAL STAMP IN GREEN

Jeffrey I. Lee
Professional Surveyor 6359
January 20, 2003

L-3441

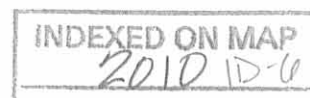

REC'D 1-28-04 SMM OK
Lee Surveying and Mapping Co., Inc.

Land Surveys • Topography • Subdivisions • Construction Layout

117 N. Madriver St.
Bellefontaine OH 43311



Phone: (937) 593-7335
Fax: (937) 593-7444

**TRACT H-8
5.021 ACRES**

Lying in Virginia Military Survey 4493-4525, Monroe Township, Logan County, Ohio.

Being out of the Countrytyme Grove City Ltd. 53.602 acre tract as deeded and described on Official Record 691, Page 702 of the Logan County Records of Deeds and being more particularly described as follows:

Beginning at a 3/4 inch iron rod found in a monument box at the intersection of center-lines of County Highway 5 (60 feet wide) and Township Road 165 (60 feet wide).

THENCE, with the center-line of County Highway 5, N 18°-24'-41"E, a distance 1442.01 feet to a MAG nail set at THE TRUE POINT OF BEGINNING.

THENCE, N 71°-35'-19"W, a distance of 810.00 feet to a 5/8 inch iron rod set, passing a 5/8 inch iron rod set at 30.00 feet.

THENCE, N 18°-24'-41"E, a distance of 270.00 feet to a 5/8 inch iron rod set.

THENCE, S 71°-35'-19"E, a distance of 810.00 feet to a MAG nail set, passing a 5/8 inch iron rod set at 780.00 feet.

THENCE, with the center-line of County Highway 5, S 18°-24'-41"W, a distance of 270.00 feet to the point of beginning.

Containing 5.021 acres of which 0.186 acre is within the highway right-of-way.

The basis for bearings is the center-line of County Highway 5 being S 18°-24'-41"W, and all other bearings are from angles and distances measured in a field survey by Lee Surveying and Mapping Co., Inc. on December 19, 2003.

Description prepared by:



ORIGINAL STAMP IN GREEN

A handwritten signature in black ink, appearing to read 'Jeffrey I. Lee'.

Jeffrey I. Lee
Professional Surveyor 6359
January 20, 2003

L-3441

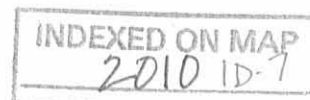

REC'D 1-28-04 SMJ dk
Lee Surveying and Mapping Co., Inc.

Land Surveys • Topography • Subdivisions • Construction Layout

117 N. Madriver St.
Bellefontaine OH 43311



Phone: (937) 593-7335
Fax: (937) 593-7444

**TRACT J-9
5.021 ACRES**

Lying in Virginia Military Survey 4493-4525, Monroe Township, Logan County, Ohio.

Being out of the Countrytyme Grove City Ltd. 53.602 acre tract as deeded and described on Official Record 691, Page 702 of the Logan County Records of Deeds and being more particularly described as follows:

Beginning at a 3/4 inch iron rod found in a monument box at the intersection of center-lines of County Highway 5 (60 feet wide) and Township Road 165 (60 feet wide).

THENCE, with the center-line of County Highway 5, N 18°-24'-41"E, a distance 1172.01 feet to a MAG nail set at THE TRUE POINT OF BEGINNING.

THENCE, N 71°-35'-19"W, a distance of 810.00 feet to a 5/8 inch iron rod set, passing a 5/8 inch iron rod set at 30.00 feet.

THENCE, N 18°-24'-41"E, a distance of 270.00 feet to a 5/8 inch iron rod set.

THENCE, S 71°-35'-19"E, a distance of 810.00 feet to a MAG nail set, passing a 5/8 inch iron rod set at 780.00 feet.

THENCE, with the center-line of County Highway 5, S 18°-24'-41"W, a distance of 270.00 feet to the point of beginning.

Containing 5.021 acres of which 0.186 acre is within the highway right-of-way.

The basis for bearings is the center-line of County Highway 5 being S 18°-24'-41"W, and all other bearings are from angles and distances measured in a field survey by Lee Surveying and Mapping Co., Inc. on December 19, 2003.

Description prepared by:



ORIGINAL STAMP IN GREEN

Jeffrey I. Lee
Professional Surveyor 6359
January 20, 2003

L-3441

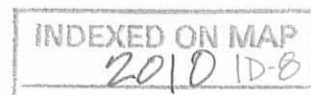

REC'D 1-28-04 SMM OK
Lee Surveying and Mapping Co., Inc.

Land Surveys • Topography • Subdivisions • Construction Layout

117 N. Madriver St.
Bellefontaine OH 43311



Phone: (937) 593-7335
Fax: (937) 593-7444

**TRACT K-10
5.021 ACRES**

Lying in Virginia Military Survey 4493-4525, Monroe Township, Logan County, Ohio.

Being out of the Countrytyme Grove City Ltd. 53.602 acre tract as deeded and described on Official Record 691, Page 702 of the Logan County Records of Deeds and being more particularly described as follows:

Beginning at a 3/4 inch iron rod found in a monument box at the intersection of center-lines of County Highway 5 (60 feet wide) and Township Road 165 (60 feet wide).

THENCE, with the center-line of County Highway 5, N 18°-24'-41"E, a distance 902.01 feet to a MAG nail set at THE TRUE POINT OF BEGINNING.

THENCE, N 71°-35'-19"W, a distance of 810.00 feet to a 5/8 inch iron rod set, passing a 5/8 inch iron rod set at 30.00 feet.

THENCE, N 18°-24'-41"E, a distance of 270.00 feet to a 5/8 inch iron rod set.

THENCE, S 71°-35'-19"E, a distance of 810.00 feet to a MAG nail set, passing a 5/8 inch iron rod set at 780.00 feet.

THENCE, with the center-line of County Highway 5, S 18°-24'-41"W, a distance of 270.00 feet to the point of beginning.

Containing 5.021 acres of which 0.186 acre is within the highway right-of-way.

The basis for bearings is the center-line of County Highway 5 being S 18°-24'-41"W, and all other bearings are from angles and distances measured in a field survey by Lee Surveying and Mapping Co., Inc. on December 19, 2003.

Description prepared by:



ORIGINAL STAMP IN GREEN

Jeffrey I. Lee
Professional Surveyor 6359
January 20, 2003

L-3441

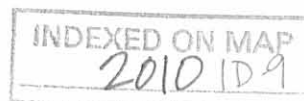

REV'D 1-28-04 COM OK
Lee Surveying and Mapping Co., Inc.

Land Surveys • Topography • Subdivisions • Construction Layout

117 N. Madriver St.
Bellefontaine OH 43311



Phone: (937) 593-7335
Fax: (937) 593-7444

TRACT L-11
9.595 ACRES

Lying in Virginia Military Survey 4493-4525, Monroe Township, Logan County, Ohio.

Being out of the Countrytyme Grove City Ltd. 53.602 acre tract as deeded and described on Official Record 691, Page 702 of the Logan County Records of Deeds and being more particularly described as follows:

Beginning at a 3/4 inch iron rod found in a monument box at the intersection center-lines of County Highway 5 (60 feet wide) and Township Road 165 (60 feet wide).

THENCE, with the center-line of County Highway 5, N 18°-24'-41"E, a distance 142.79 feet to a MAG nail found at THE TRUE POINT OF BEGINNING.

THENCE, with the northeasterly line of the Neil D. Yoder and Diane Sue Yoder, 65.595 acre tract (O.R. 520, Pg. 495), N 40°-36'-09"W, a distance of 944.84 feet to a 5/8 inch iron rod set, passing a 5/8 inch iron rod found at 34.78 feet.

THENCE, N 18°-24'-41"E, a distance of 272.79 feet to a 5/8 inch iron rod set.

THENCE, S 71°-35'-19"E, a distance of 810.00 feet to a MAG nail set, passing a 5/8 inch iron rod set at 780.00 feet.

THENCE, with the center-line of County Highway 5, S 18°-24'-41"W, a distance of 759.22 feet to the point of beginning.

Containing 9.595 acres of which 0.517 acre is within the highway right-of-way.

The basis for bearings is the center-line of County Highway 5 being S 18°-24'-41"W, and all other bearings are from angles and distances measured in a field survey by Lee Surveying and Mapping Co., Inc. on December 19, 2003.

Description prepared by:



ORIGINAL STAMP IN GREEN

A handwritten signature in black ink, appearing to read 'Jeffrey I. Lee'.

Jeffrey I. Lee
Professional Surveyor 6359
January 20, 2003

L-3441



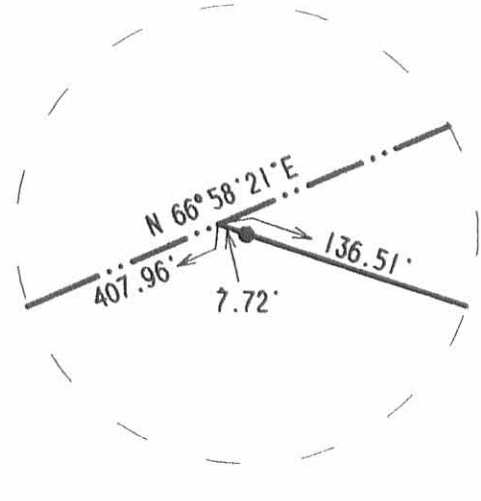

DETAIL A

KEVIN J. FORREST
AND PEGGY J. FORREST
35.28 ACRES
O.R. 153, PG. 612

THOMAS W. GODWIN
AND C. JOAN GODWIN
ORIG. 189.963 ACRES
O.R. 92, PG. 145

JOHN M. KAUFFMAN
1.256 ACRE TRACT
O.R. 623, PG. 526

JESSALYN I. STRAYER
ORIG. 58.554 ACRES
O.R. 178, PG. 463
PARCEL TWO

NEIL D. YODER AND
DIANE SUE YODER
65.595 ACRES
O.R. 520, PG. 465

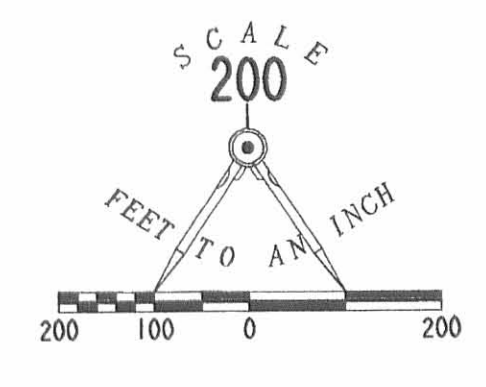

VIRGINIA MILITARY SURVEY 10853
VIRGINIA MILITARY SURVEY 4493-4525

VIRGINIA MILITARY SURVEY 10853
VIRGINIA MILITARY SURVEY 12099

VIRGINIA MILITARY SURVEY 12099
VIRGINIA MILITARY SURVEY 4493-4525

MAD RIVER

COUNTY HIGHWAY 5 (60')

TOWNSHIP ROAD 165 (60')

TRACT CD-12
5.484 ACRES

TRACT B-2
5.493 ACRES

TRACT A-1
5.631 ACRES

TRACT L-11
9.595 ACRES
0.517 ACRE
WITHIN RIGHT OF WAY

TRACT K-10
5.021 ACRES
0.186 ACRE
WITHIN RIGHT OF WAY

TRACT J-9
5.021 ACRES
0.186 ACRE
WITHIN RIGHT OF WAY

TRACT H-8
5.021 ACRES
0.186 ACRE
WITHIN RIGHT OF WAY

TRACT G-7
5.021 ACRES
0.186 ACRE
WITHIN RIGHT OF WAY

TRACT F-6
5.370 ACRES
0.187 ACRE
WITHIN RIGHT OF WAY

TRACT E-5
1.946 ACRES

- LEGEND
- 5/8 INCH IRON ROD FOUND
 - ⊗ MAG NAIL FOUND
 - ⊗ 3/4 INCH IRON ROD FOUND IN A MONUMENT BOX
 - RAILROAD TIE POST FOUND
 - ⊗ 1 INCH IRON ROD FOUND IN A MONUMENT BOX
 - 5/8 INCH IRON ROD SET
 - ⊗ MAG NAIL SET

SURVEY OF 10 TRACTS
OUT OF THE COUNTRYME GROVE CITY LTD.
ORIGINAL 53.602 ACRE TRACT
OFFICIAL RECORD 691, PAGE 702
VIRGINIA MILITARY SURVEY 4493-4525
MONROE TOWNSHIP
LOGAN COUNTY, OHIO

2 WORKING DAYS
BEFORE YOU DIG
CALL TOLL FREE **800-362-2764**
OHIO UTILITIES PROTECTION SERVICE.

INDEXED ON MAP
2010



SURVEYED BY:
Jeffrey I. Lee
JEFFREY I. LEE
PROFESSIONAL SURVEYOR 6359
DECEMBER 19, 2003

COPYRIGHT 2004 BY:
LEE SURVEYING & MAPPING CO., INC.
117 North Madriver Street
BELLEFONTAINE, OHIO 43311
(937) 593-7335

REC'D 2-18-04 SMY OK

Lee Surveying and Mapping Co., Inc.

Land Surveys • Topography • Subdivisions • Construction Layout

117 N. Madriver St.
Bellefontaine OH 43311



Phone: (937) 593-7335
Fax: (937) 593-7444

TRACT EF-13 7.316 ACRES

Lying in Virginia Military Survey 4493-4525, Monroe Township, Logan County, Ohio.

Being out of the Countrytyme Grove City Ltd. 53.602 acre tract as deeded and described on Official Record 691, Page 702 of the Logan County Records of Deeds and being more particularly described as follows:

Beginning at a 3/4 inch iron rod found in a monument box at the intersection center-lines of County Highway 5 (60 feet wide) and Township Road 165 (60 feet wide).

THENCE, with the center-line of County Highway 5, N 18°-24'-41"E, a distance of 1982.01 feet to a MAG nail set at THE TRUE POINT OF BEGINNING.

THENCE, N 71°-35'-19"W, a distance of 946.51 feet to a point, passing 5/8 inch iron rod set at 30.00 feet and 938.79 feet.

THENCE, with the south lines of Virginia Military Survey 12099 and Thomas W. Godwin and C. Joan Godwin original 189.963 acre tract (O.R. 92, Pg. 145), N 66°-58'-21"E, a distance of 1052.53 feet to a 5/8 inch iron rod found.

THENCE, with the west line of the John M. Kauffman 1.256 acre tract (O.R. 623, Pg. 526) , S 18°-23'-55"W, a distance of 409.68 feet to a 5/8 inch iron rod found.

THENCE, with the south line line of said 1.256 acre tract, S 65°-27'-21"E, a distance of 158.28 feet to a MAG nail found on the centerline of County Highway 5, passing a 5/8 inch iron rod found at 128.11 feet.

THENCE, with the center-line of County Highway 5, S 18°-24'-41"W, a distance of 270.00 feet to the point of beginning.

Containing 7.316 acres of which 0.187 acre is within the highway right-of-way.

The basis for bearings is the center-line of County Highway 5 being S 18°-24'-41"W, and all other bearings are from angles and distances measured in a field survey by Lee Surveying and Mapping Co., Inc. on December 19, 2003.

Description prepared by:



ORIGINAL STAMP IN GREEN

Jeffrey I. Lee
Professional Surveyor 6359
January 20, 2003

L-3441

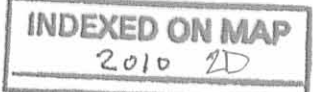

REV'D 2-18-04 SMY AK

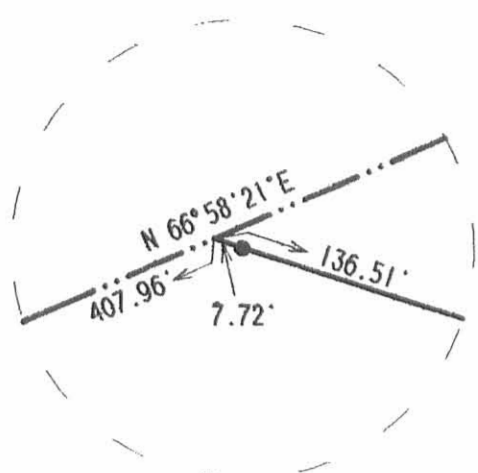

DETAIL A

KEVIN J. FORREST
AND PEGGY J. FORREST
35.28 ACRES
O.R. 153. PG. 612

THOMAS W. GODWIN
AND C. JOAN GODWIN
ORIG. 189.963 ACRES
O.R. 92. PG. 145

JOHN M. KAUFFMAN
1.256 ACRE TRACT
O.R. 623. PG. 526
STA. 214+39
F.B. 497. PG. 69

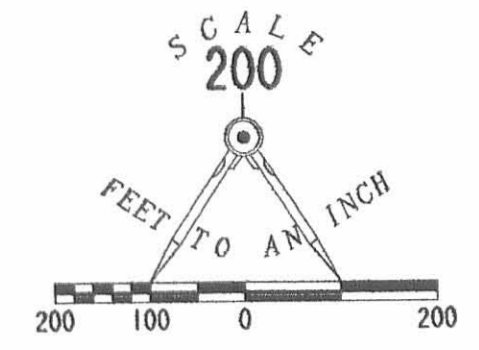

VIRGINIA MILITARY SURVEY 10853
VIRGINIA MILITARY SURVEY 4493-4525

JESSALYN I. STRAYER
ORIG. 58.554 ACRES
O.R. 178. PG. 463
PARCEL TWO

NEIL D. YODER AND
DIANE SUE YODER
65.595 ACRES
O.R. 520. PG. 465

SURVEY OF 9 TRACTS
OUT OF THE COUNTRYME GROVE CITY LTD.
ORIGINAL 53.602 ACRE TRACT
OFFICIAL RECORD 691, PAGE 702
VIRGINIA MILITARY SURVEY 4493-4525
MONROE TOWNSHIP
LOGAN COUNTY, OHIO

VIRGINIA MILITARY SURVEY 10853
VIRGINIA MILITARY SURVEY 12099

VIRGINIA MILITARY SURVEY 12099
VIRGINIA MILITARY SURVEY 4493-4525

MAD RIVER

COUNTY HIGHWAY 5 (60')
BASIS FOR BEARINGS

TOWNSHIP ROAD 165 (60')

TRACT CD-12
5.484 ACRES

TRACT EF-13
7.316 ACRES
0.187 ACRE
WITHIN RIGHT OF WAY

TRACT G-7
5.021 ACRES
0.186 ACRE
WITHIN RIGHT OF WAY

TRACT H-8
5.021 ACRES
0.186 ACRE
WITHIN RIGHT OF WAY

TRACT J-9
5.021 ACRES
0.186 ACRE
WITHIN RIGHT OF WAY

TRACT K-10
5.021 ACRES
0.186 ACRE
WITHIN RIGHT OF WAY

TRACT L-11
9.595 ACRES
0.517 ACRE
WITHIN RIGHT OF WAY

TRACT B-2
5.493 ACRES

TRACT A-1
5.631 ACRES

LEGEND

- 5/8 INCH IRON ROD FOUND
- ⊗ MAG NAIL FOUND
- ⊙ 3/4 INCH IRON ROD FOUND IN A MONUMENT BOX
- RAILROAD TIE POST FOUND
- ⊠ 1 INCH IRON ROD FOUND IN A MONUMENT BOX
- 5/8 INCH IRON ROD SET
- ⊙ MAG NAIL SET

2 WORKING DAYS
BEFORE YOU DIG
CALL TOLL FREE 800-362-2764
OHIO UTILITIES PROTECTION SERVICE.

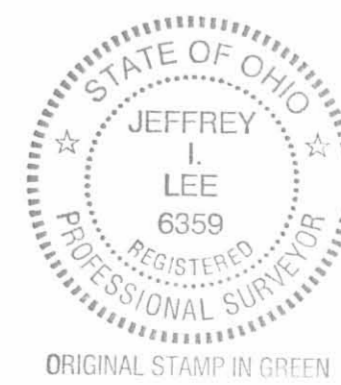

SURVEYED BY:
Jeffrey I. Lee
JEFFREY I. LEE
PROFESSIONAL SURVEYOR 6359
DECEMBER 19, 2003
REVISED FEBRUARY 12, 2004

COPYRIGHT 2004 BY:
LEE SURVEYING & MAPPING CO., INC.
117 North Madriver Street
BELLEFONTAINE, OHIO 43311
(937) 593-7335
DAN/ADW/KSR D412 GRBB6A L-3441-B-2-2

INDEXED ON MAP
2010 2P

2E'D 12-1-03 SMY OK

Lee Surveying and Mapping Co., Inc.

Land Surveys • Topography • Subdivisions • Construction Layout

117 N. Madriver St.
Bellefontaine OH 43311



Phone: (937) 593-7335
Fax: (937) 593-7444

GRUBBS 84.972 ACRES

Lying in Virginia Military Surveys 4493, 4525, and 12099, Monroe Township, Logan County, Ohio.

Being all of the Eleanor A, Grubbs 4.57 acre and 2.73 acre tracts (Tracts 1 and 6) and part of the 58.8 acre, 73.89 acre and 3.0 acre tracts (Tracts 2, 3 and 4) as deeded and described in Official Record 97, Page 796 of the Logan County Records of Deeds and being more particularly described as follows:

Beginning at a 3/4 inch iron rod found in monument box at the intersection of the center-lines of County Highway 5 and Township Road 165, also being County Highway 5 Station 190+38.7 (Logan County Engineer's Field Book 497, Page 68).

THENCE, with the center-line of County Highway 5 (60 feet wide), N 18°-24'-41"E, a distance of 2399.99 feet to a 5/8 inch iron rod found at Station 214+39 (Logan County Engineer's Field Book 497, Page 69).

THENCE, continuing with the said center-line, N 00°-23'-05"E, a distance of 341.17 feet to a 1 inch iron rod found in monument box at Station 217+80 (Field Book 497, Page 69).

THENCE, with the south line of the Premier Properties 0.61 acre and original 69.49 acre tracts (O.R. 116, Pg. 978, Tract X, Parcels X and IX), S 67°-50'-28"E, a distance of 995.54 feet to a point, passing a 6 inch wood corner post found at 32.30 feet and a 5/8 inch iron rod set at 962.54 feet.

THENCE, with the center-line of the Mad River and the west line of the James Edwin Gantz original 265.47 acre tract (Vol. 280, Pg. 345, first parcel), S 24°-21'-26"W, a distance of 205.62 feet to a point, referenced by a 5/8 inch iron rod set N 69°-15'-53"W, a distance of 20.00 feet.

THENCE, continuing with the center-line of Mad River and the west line of the said 265.47 acre tract, S 02°-39'-31"W, a distance of 878.55 feet to a point.

THENCE, with a westerly line of Virginia Military Survey 12099, S 18°-28'-18"E, a distance of 48.00 feet to a 5/8 inch iron rod set.

THENCE, with the west line of the Don E. Maples, Trustee original 28.83 acre tract (O.R. 374, Pg. 674 Tract 4), S 05°-23'-38"W, a distance of 2122.70 feet to a railroad spike found, passing a 5/8 inch iron rod set at 2087.56 feet.

THENCE, with the center-line of Township Road 165 (60 feet wide), the following three courses:

- 1.) N 53°-13'-48"W, a distance of 95.85 feet to a 3/4 inch iron rod found.
- 2.) S 87°-43'-42"W, a distance of 340.77 feet to a 1 inch iron pipe found.
- 3.) N 45°-32'-48"W, a distance of 1338.06 feet to the point of beginning.

Containing 84.972 acres, of which 3.089 acres are within the highway rights-of-way.

The basis for bearings is the center-line of County Highway 5, being N 18°-24'-41"E, and all other bearings are from angles and distances measured in a field survey by Lee Surveying and Mapping Co., Inc. on November 12, 2003.

Description prepared by:

Jeffrey I. Lee
Professional Surveyor 6359
November 19, 2003



L-3441



ORIGINAL STAMP IN GREEN

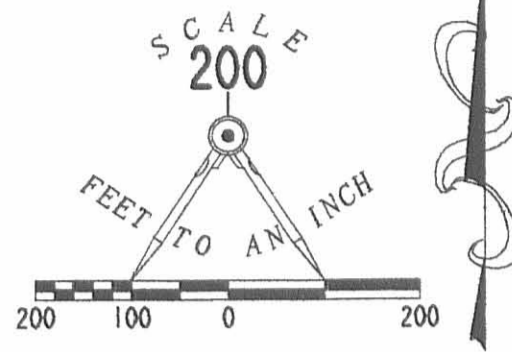
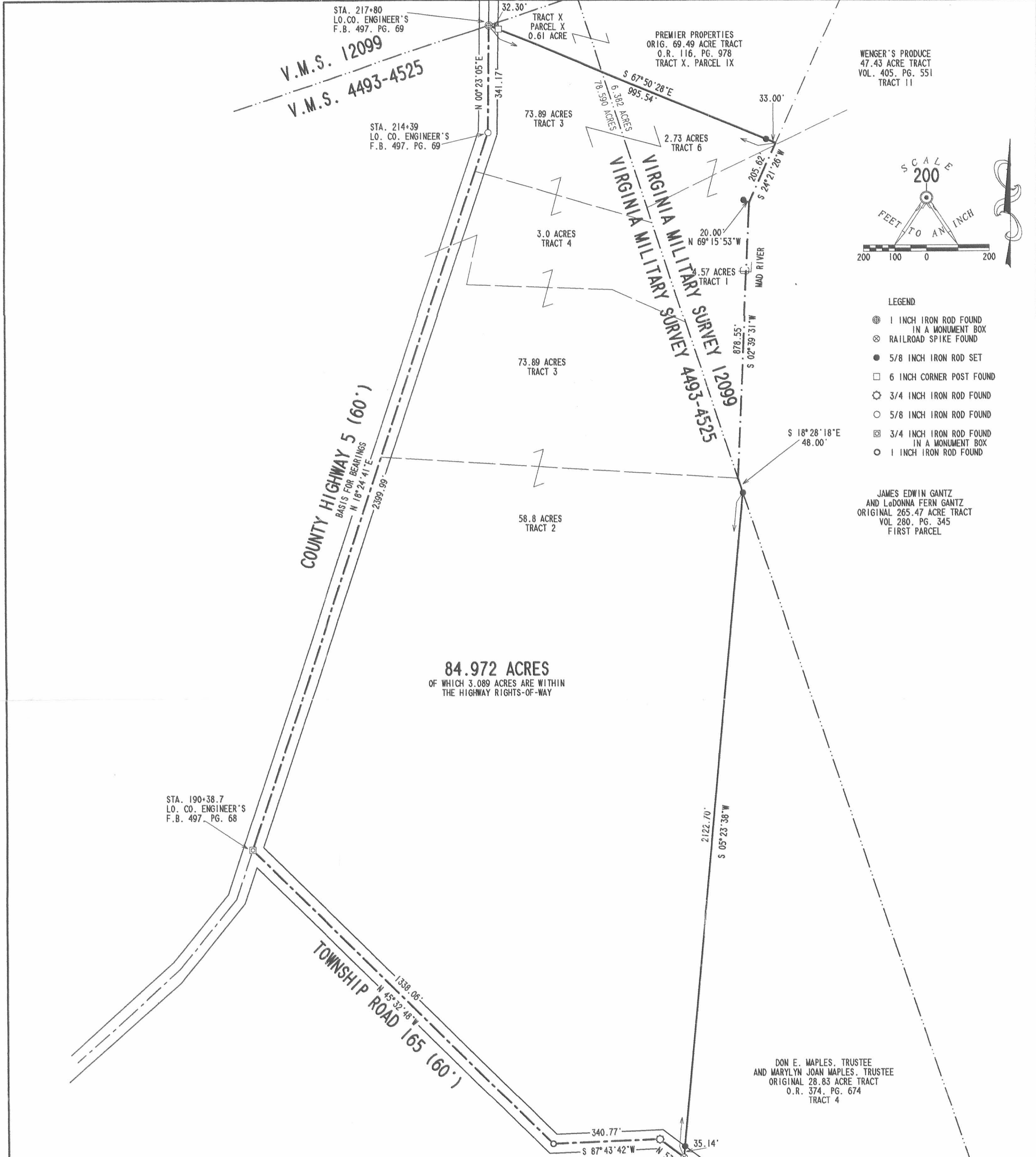

- LEGEND**
- ⊙ 1 INCH IRON ROD FOUND IN A MONUMENT BOX
 - ⊗ RAILROAD SPIKE FOUND
 - 5/8 INCH IRON ROD SET
 - 6 INCH CORNER POST FOUND
 - ⊙ 3/4 INCH IRON ROD FOUND
 - 5/8 INCH IRON ROD FOUND
 - ⊠ 3/4 INCH IRON ROD FOUND IN A MONUMENT BOX
 - 1 INCH IRON ROD FOUND

JAMES EDWIN GANTZ AND LADONNA FERN GANTZ ORIGINAL 265.47 ACRE TRACT VOL. 280, PG. 345 FIRST PARCEL

DON E. MAPLES, TRUSTEE AND MARYLYN JOAN MAPLES, TRUSTEE ORIGINAL 28.83 ACRE TRACT O.R. 374, PG. 674 TRACT 4

I HEREBY STATE TO THE TITLE COMPANY, LTD. THAT I HAVE SURVEYED THE PROPERTY IN THE FORGOING TITLE CAPTION AND THAT SAID SURVEY IS TRUE AND ACCURATE TO THE BEST OF MY KNOWLEDGE AND BELIEF.

SURVEY OF ALL OF THE ELEANOR A. GRUBBS 4.57 ACRE TRACT, 2.73 ACRE TRACT (TRACTS 1 AND 6) AND PART OF THE 58.8 ACRE AND 3.0 ACRE TRACT (TRACTS 2, 3, AND 4) OFFICIAL RECORD 97, PAGE 796 VIRGINIA MILITARY SURVEYS 4493, 4525, AND 12099 MONROE TOWNSHIP LOGAN COUNTY, OHIO



JEFFREY I. LEE PROFESSIONAL SURVEYOR 6359 NOVEMBER 12, 2003

COPYRIGHT 2003 BY: LEE SURVEYING & MAPPING CO., INC. 117 North Medriver Street BELLEFONTAINE, OHIO 43111 (937) 593-7335

2 WORKING DAYS BEFORE YOU DIG CALL TOLL FREE 800-362-2764 OHIO UTILITIES PROTECTION SERVICE.

INDEXED ON MAP 2010 3P