

1 REC'D 9-29-95 SMY OK ✓



Lee Surveying and Mapping Co.



Farm Surveys • Lot Surveys • Topography • Subdivisions • Construction Layout

143 EAST COLUMBUS AVENUE
BELLEFONTAINE, OHIO 43311

(513) 593-7335

JEFFREY I. LEE, P.S.

KNIGHT & KELLY TRACT A 1.475 ACRES

Lying in Section 31, Town 3, Range 14, Pleasant Township, Logan County, Ohio.

Being out of the Lawrence Knight, Charles Richard Knight, and Mary Jane Kelly original 86.0 acre tract as deeded and described in Official Record 181, Page 700 of the Logan County Records of Deeds and being more particularly described as follows:

Beginning at a railroad spike found at the intersection of center-lines of Township Road 43 and County Highway 11.

THENCE, with the center-line of County Highway 11 (60 feet wide), S 0°-24'-50" E, a distance of 154.57 feet to a railroad spike set.

THENCE, N 84°-39'-42" W, a distance of 431.06 feet to a 5/8 inch iron rod set.

THENCE, N 5°-37'-00" E, a distance of 150.02 feet to a railroad spike set.

THENCE, with the center-line of Township Road 43 (60 feet wide), S 85°-11'-00" E, a distance of 414.85 feet to the point of beginning.

Containing 1.475 acres of which 0.372 acre is within the highway right-of-way.

The basis for bearings is the center-line of Township Road 43 being S 85°-11'-00" E, and all other bearings are from angles and distances measured in a field survey by Lee Surveying and Mapping Company on September 22, 1995.

Description prepared by:



[Handwritten Signature]
Jeffrey I. Lee
Professional Surveyor 6359
September 27, 1995

L 2248

ORIGINAL STAMP IN GREEN

INDEXED ON MAP
9100 1D-1

REC'D 9-28-95 SWM OK ✓



Lee Surveying and Mapping Co.



Farm Surveys • Lot Surveys • Topography • Subdivisions • Construction Layout

143 EAST COLUMBUS AVENUE
BELLEFONTAINE, OHIO 43311

(513) 593-7335

JEFFREY I. LEE, P.S.

KNIGHT & KELLY TRACT B 1.516 ACRES

Lying in Section 31, Town 3, Range 14, Pleasant Township, Logan County, Ohio.

Being out of the Lawrence Knight, Charles Richard Knight, and Mary Jane Kelly original 86.0 acre tract as deeded and described in Official Record 181, Page 700 of the Logan County Records of Deeds and being more particularly described as follows:

Beginning at a railroad spike found at the intersection of center-lines of Township Road 43 and County Highway 11.

THENCE, with the center-line of County Highway 11 (60 feet wide), S 0°-24'-50" E, a distance of 154.57 feet to a railroad spike set at the TRUE POINT OF BEGINNING.

THENCE, with the center-line of County Highway 11, S 0°-24'-50" E, a distance of 151.22 feet to a railroad spike set

THENCE, N 84°-39'-42" W, a distance of 446.94 feet to a 5/8 inch iron rod set.

THENCE, N 5°-37'-00" E, a distance of 150.46 feet to a 5/8 inch iron rod set.

THENCE, S 84°-39'-42" E, a distance of 431.06 feet to the point of beginning.

Containing 1.516 acres of which 0.104 acre is within the highway right-of-way.

The basis for bearings is the center-line of Township Road 43 being S 85°-11'-00" E, and all other bearings are from angles and distances measured in a field survey by Lee Surveying and Mapping Company on September 22, 1995.

Description prepared by:

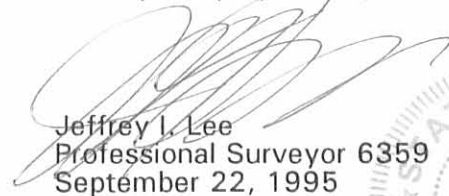
Jeffrey I. Lee
Professional Surveyor 6359
September 22, 1995



L 2248

ORIGINAL STAMP IN GREEN

INDEXED ON MAP
9.100 1D-2

REC'D 9-28-95 SMY OK ✓



Lee Surveying and Mapping Co.



Farm Surveys • Lot Surveys • Topography • Subdivisions • Construction Layout

143 EAST COLUMBUS AVENUE
BELLEFONTAINE, OHIO 43311

(513) 593-7335

JEFFREY I. LEE, P.S.

KNIGHT & KELLY TRACT C 1.509 ACRES

Lying in Section 31, Town 3, Range 14, Pleasant Township, Logan County, Ohio.

Being out of the Lawrence Knight, Charles Richard Knight, and Mary Jane Kelly original 86.0 acre tract as deeded and described in Official Record 181, Page 700 of the Logan County Records of Deeds and being more particularly described as follows:

Beginning at a railroad spike found at the intersection of center-lines of Township Road 43 and County Highway 11.

THENCE, with the center-line of County Highway 11 (60 feet wide), S 0°-24'-50" E, a distance of 305.79 feet to a railroad spike set at the TRUE POINT OF BEGINNING.

THENCE, with the center-line of County Highway 11, S 0°-24'-50" E, a distance of 64.64 feet to a 1/2 inch iron rod found, passing a 1 inch metal pipe found at the intersection of center-lines of County Highway 11 and County Highway 43 at 42.30 feet.

THENCE, with the center-line of County Highway 11, S 35°-21'-36" W, a distance of 98.96 feet to a railroad spike set.

THENCE, N 84°-39'-42" W, a distance of 404.64 feet to a 5/8 inch iron rod set.

THENCE, N 5°-37'-00" E, a distance of 150.00 feet to a 5/8 inch iron rod set.

THENCE, S 84°-39'-42" E, a distance of 446.94 feet to the point of beginning.

Containing 1.509 acres of which 0.113 acre is within the highway right-of-way.

The basis for bearings is the center-line of Township Road 43 being S 85°-11'-00" E, and all other bearings are from angles and distances measured in a field survey by Lee Surveying and Mapping Company on September 22, 1995.

Description prepared by:

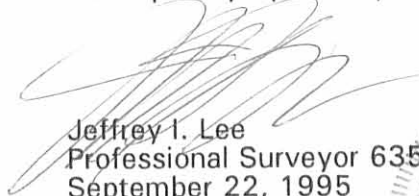
Jeffrey I. Lee
Professional Surveyor 6359
September 22, 1995



L 2248

ORIGINAL STAMP IN GREEN

INDEXED ON MAP
9100 ID-3

1 REC'D 9-29-95 SWY OK ✓



Lee Surveying and Mapping Co.



Farm Surveys • Lot Surveys • Topography • Subdivisions • Construction Layout

143 EAST COLUMBUS AVENUE
BELLEFONTAINE, OHIO 43311

(513) 593-7335

JEFFREY I. LEE, P.S.

KNIGHT & KELLY TRACT D 1.245 ACRES

Lying in Section 31, Town 3, Range 14, Pleasant Township, Logan County, Ohio.

Being out of the Lawrence Knight, Charles Richard Knight, and Mary Jane Kelly original 86.0 acre tract as deeded and described in Official Record 181, Page 700 of the Logan County Records of Deeds and being more particularly described as follows:

Beginning at a 1 inch metal pipe found at the intersection of center-lines of County Highway 43 and County Highway 11.

THENCE, with the center-line of County Highway 11, S 0°24'50"E, a distance of 22.34 feet to a 1/2 inch iron rod found

THENCE, with the center-line of County Highway 11, S 35°-21'-36" W, a distance of 98.96 feet to a railroad spike set at the TRUE POINT OF BEGINNING.

THENCE, with the center-line of County Highway 11, S 35°-21'-36" W, a distance of 173.24 feet to a railroad spike set

THENCE, N 84°-39'-42" W, a distance of 318.69 feet to a 5/8 inch iron rod set.

THENCE, N 5°-37'-00" E, a distance of 150.00 feet to a 5/8 inch iron rod set.

THENCE, S 84°-39'-42" E, a distance of 404.64 feet to the point of beginning.

Containing 1.245 acres of which 0.119 acre is within the highway right-of-way.

The basis for bearings is the center-line of Township Road 43 being S 85°-11'-00" E, and all other bearings are from angles and distances measured in a field survey by Lee Surveying and Mapping Company on September 22, 1995.

Description prepared by:



Jeffrey I. Lee
Professional Surveyor 6359
September 22, 1995

L 2248

ORIGINAL STAMP IN GREEN

INDEXED ON MAP
9100 1D-4

REC'D 9-28-95 SJM ou ✓



Lee Surveying and Mapping Co.



Farm Surveys • Lot Surveys • Topography • Subdivisions • Construction Layout

143 EAST COLUMBUS AVENUE
BELLEFONTAINE, OHIO 43311

(513) 593-7335

JEFFREY I. LEE, P.S.

KNIGHT & KELLY TRACT E 7.391 ACRES

Lying in Section 31, Town 3, Range 14, Pleasant Township, Logan County, Ohio.

Being out of the Lawrence Knight, Charles Richard Knight, and Mary Jane Kelly original 86.0 acre tract as deeded and described in Official Record 181, Page 700 of the Logan County Records of Deeds and being more particularly described as follows:

Beginning at a 1 inch metal pipe found at the intersection of center-lines of County Highway 43 and County Highway 11.

THENCE, with the center-line of County Highway 11, S 0°24'50"E, a distance of 22.34 feet to a 1/2 inch iron rod found

THENCE, with the center-line of County Highway 11, S 35°-21'-36" W, a distance of 272.20 feet to a railroad spike set at the TRUE POINT OF BEGINNING.

THENCE, with the center-line of County Highway 11, S 35°-21'-36" W, a distance of 189.19 feet to a railroad spike set

THENCE, with the north line of the Gene E. Bluemenshein, Trustee, 25.00 acre tract (O.R. 221, Pg. 933), N 83°-07'-26" W, a distance of 594.97 feet to a 5/8 inch iron rod set.

THENCE, N 5°-37'-00" E, a distance of 744.96 feet to a railroad spike set.

THENCE, with the center-line of Township Road 43 (60 feet wide), S 85°-11'-00" E, a distance of 370.04 feet to a railroad spike set.

THENCE, S 5°-37'-00" E, a distance of 600.48 feet to a 5/8 inch iron rod set.

THENCE, S 84°-39'-42" E, a distance of 318.69 feet to the point of beginning.

Containing 7.391 acres of which 0.385 acre is within the highway right-of-way.

The basis for bearings is the center-line of Township Road 43 being S 85°-11'-00" E, and all other bearings are from angles and distances measured in a field survey by Lee Surveying and Mapping Company on September 22, 1995.

Description prepared by:

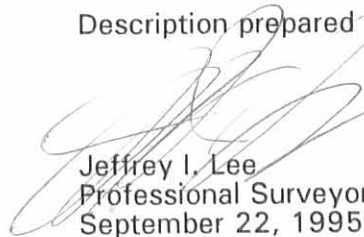
Jeffrey I. Lee
Professional Surveyor 6359
September 22, 1995



L 2248

ORIGINAL STAMP IN GREEN

INDEXED ON MAP
9100 1D-5

REC'D 10-4-95 SWY OK ✓



Lee Surveying and Mapping Co.



Farm Surveys • Lot Surveys • Topography • Subdivisions • Construction Layout

143 EAST COLUMBUS AVENUE
BELLEFONTAINE, OHIO 43311

(513) 593-7335

JEFFREY I. LEE, P.S.

KNIGHT & KELLY TRACT F 6.103 ACRES

Lying in Section 31, Town 3, Range 14, Pleasant Township, Logan County, Ohio.

Being out of the Lawrence Knight, Charles Richard Knight, and Mary Jane Kelly original 86.0 acre tract as deeded and described in Official Record 181, Page 700 of the Logan County Records of Deeds and being more particularly described as follows:

Beginning at a railroad spike found at the intersection of center-lines of Township Road 43 and County Highway 11.

THENCE, with the center-line of Township Road 43 (60 feet wide), N 85°-11'-00" W, a distance of 784.89 feet to a railroad spike set at the TRUE POINT OF BEGINNING.

THENCE, S 5°-37'-00" W, a distance of 744.96 feet to a 5/8 inch iron rod set.

THENCE, with the north line of the Gene E. Bluemenshein, Trustee, 25.00 acre tract (O.R. 221, Pg. 933), N 83°-07'-26" W, a distance of 360.09 feet to a 5/8 inch iron rod set.

THENCE, with the east line of the Mark A. McClintick 5.952 acre tract (O.R. 234, Pg. 297), N 5°-37'-00" E, a distance of 732.02 feet to a chiseled mark found, passing a chiseled 'X' set on a concrete culvert at 702.02 feet.

THENCE, with the center-line of Township Road 43, S 85°-11'-00" E, a distance of 360.04 feet to the point of beginning.

Containing 6.103 acres of which 0.248 acre is within the highway right-of-way.

The basis for bearings is the center-line of Township Road 43 being S 85°-11'-00" E, and all other bearings are from angles and distances measured in a field survey by Lee Surveying and Mapping Company on September 22, 1995.

Description prepared by:

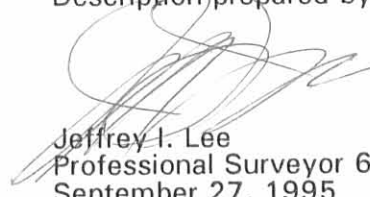

Jeffrey I. Lee
Professional Surveyor 6359
September 27, 1995
Revised October 3, 1995

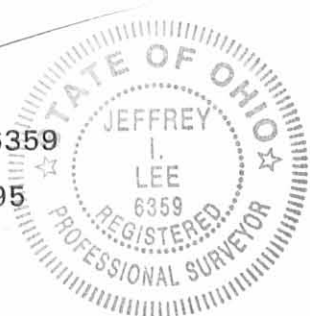

L 2248

ORIGINAL STAMP IN GREEN

INDEXED ON MAP
9100 1D-6



2 WORKING DAYS
BEFORE YOU DIG
CALL TOLL FREE 800-362-2764
OHIO UTILITIES PROTECTION SERVICE.

D 264 CDKELLY4 I-2248-1

REC'D 4-4-96 July OK ✓



Lee Surveying and Mapping Co., Inc.



Farm Surveys • Lot Surveys • Topography • Subdivisions • Construction Layout

143 EAST COLUMBUS AVENUE
BELLEFONTAINE, OHIO 43311

(513) 593-7335
FAX (513) 593-7444

CLIFFORD KELLY TRACT G 1.360 ACRES

Lying in Section 31, Town 3, Range 14, Pleasant Township, Logan County, Ohio.

Being out of the Clifford E. Kelly 6.103 acre tract as deeded and described in Official Record 276, Page 36 of the Logan County Records of Deeds and being more particularly described as follows:

Beginning at a railroad spike found at the intersection of center-lines of Township Road 43 and County Highway 11.

THENCE, with the center-line of Township Road 43 (60 feet wide), N 85°-11'-00" W, a distance of 784.89 feet to a 5/8 inch iron rod found at the TRUE POINT OF BEGINNING.

THENCE, with the west line of the Clifford E. Kelly 7.391 acre tract (O.R. 276, Pg. 34), S 5°-37'-00" W, a distance of 394.96 feet to a 5/8 inch iron rod set.

THENCE, N 85°-11'-00" W, a distance of 150.00 feet to a 5/8 inch iron rod set.

THENCE, N 5°-37'-00" E, a distance of 394.96 feet to a 5/8 inch iron rod set.

THENCE, with the center-line of Township Road 43, S 85°-11'-00" E, a distance of 150.00 feet to the point of beginning.

Containing 1.360 acres of which 0.103 acre is within the highway right-of-way.

The basis for bearings is the center-line of Township Road 43 being S 85°-11'-00" E, and all other bearings are from angles and distances measured in a field survey by Lee Surveying and Mapping Co., Inc. on April 1, 1996.

Description prepared by:

Jeffrey I. Lee
Professional Surveyor 6359
April 4, 1996



L 2248

ORIGINAL STAMP IN GREEN

INDEXED ON MAP
9100 2D-1

1 REC'D 4-4-96 SURV OK ✓



Lee Surveying and Mapping Co., Inc.



Farm Surveys • Lot Surveys • Topography • Subdivisions • Construction Layout

143 EAST COLUMBUS AVENUE
BELLEFONTAINE, OHIO 43311

(513) 593-7335
FAX (513) 593-7444

CLIFFORD KELLY TRACT H 1.360 ACRES

Lying in Section 31, Town 3, Range 14, Pleasant Township, Logan County, Ohio.

Being out of the Clifford E. Kelly 6.103 acre tract as deeded and described in Official Record 276, Page 36 of the Logan County Records of Deeds and being more particularly described as follows:

Beginning at a railroad spike found at the intersection of center-lines of Township Road 43 and County Highway 11.

THENCE, with the center-line of Township Road 43 (60 feet wide), N 85°-11'-00" W, a distance of 934.89 feet to a 5/8 inch iron rod set at the TRUE POINT OF BEGINNING.

THENCE, S 5°-37'-00" W, a distance of 394.96 feet to a 5/8 inch iron rod set.

THENCE, N 85°-11'-00" W, a distance of 150.04 feet to a 5/8 inch iron rod set.

THENCE, N 5°-37'-00" E, a distance of 394.96 feet to a 5/8 inch iron rod set.

THENCE, with the center-line of Township Road 43, S 85°-11'-00" E, a distance of 150.04 feet to the point of beginning.

Containing 1.360 acres of which 0.103 acre is within the highway right-of-way.

The basis for bearings is the center-line of Township Road 43 being S 85°-11'-00" E, and all other bearings are from angles and distances measured in a field survey by Lee Surveying and Mapping Co., Inc. on April 1, 1996.

Description prepared by:

Jeffrey I. Lee
Professional Surveyor 6359
April 1, 1996



L 2248

ORIGINAL STAMP IN GREEN

INDEXED ON MAP
9100 2D-2

REC'D 4-17-96 SMJ OK ✓



Lee Surveying and Mapping Co., Inc.



Farm Surveys • Lot Surveys • Topography • Subdivisions • Construction Layout

143 EAST COLUMBUS AVENUE
BELLEFONTAINE, OHIO 43311

(513) 593-7335
FAX (513) 593-7444

CLIFFORD KELLY TRACT J 3.383 ACRES

Lying in Section 31, Town 3, Range 14, Pleasant Township, Logan County, Ohio.

Being out of the Clifford E. Kelly 6.103 acre tract as deeded and described in Official Record 276, Page 36 of the Logan County Records of Deeds and being more particularly described as follows:

Beginning at a railroad spike found at the intersection of center-lines of Township Road 43 and County Highway 11.

THENCE, with the center-line of Township Road 43 (60 feet wide), N 85°-11'-00" W, a distance of 1084.93 feet to a 5/8 inch iron rod set at the TRUE POINT OF BEGINNING.

THENCE, S 5°-37'-00" W, a distance of 394.96 feet to a 5/8 inch iron rod set.

THENCE, S 85°-11'-00" E, a distance of 300.04 feet to a 5/8 inch iron rod set.

THENCE, with the west line of the Clifford E. Kelly 7.391 acre tract (O.R. 276, Pg. 34), S 5°-37'-00" W, a distance of 350.00 feet to a 5/8 inch iron rod set.

THENCE, with the north line of the Gene E. Blumenshein, Trustee, 25.00 acre tract (O.R. 221, Pg. 933), N 83°-07'-26" W, a distance of 360.09 feet to a 5/8 inch iron rod set.

THENCE, with the east line of the Mark A. McClintick 5.952 acre tract (O.R. 234, Pg. 297), N 5°-37'-00" E, a distance of 732.02 feet to a drill hole found in concrete, passing a chiseled 'X' found on a concrete culvert at 702.02 feet.

THENCE, with the center-line of Township Road 43, S 85°-11'-00" E, a distance of 60.00 feet to the point of beginning.

Containing 3.383 acres of which 0.042 acre is within the highway right-of-way.

The basis for bearings is the center-line of Township Road 43 being S 85°-11'-00" E, and all other bearings are from angles and distances measured in a field survey by Lee Surveying and Mapping Co., Inc. on April 1, 1996.

Description prepared by:



Jeffrey I. Lee
Professional Surveyor 6359
April 4, 1996
Rev. April 10, 1996

ORIGINAL STAMP IN GREEN

L 2248

INDEXED ON MAP
9100 2D-3

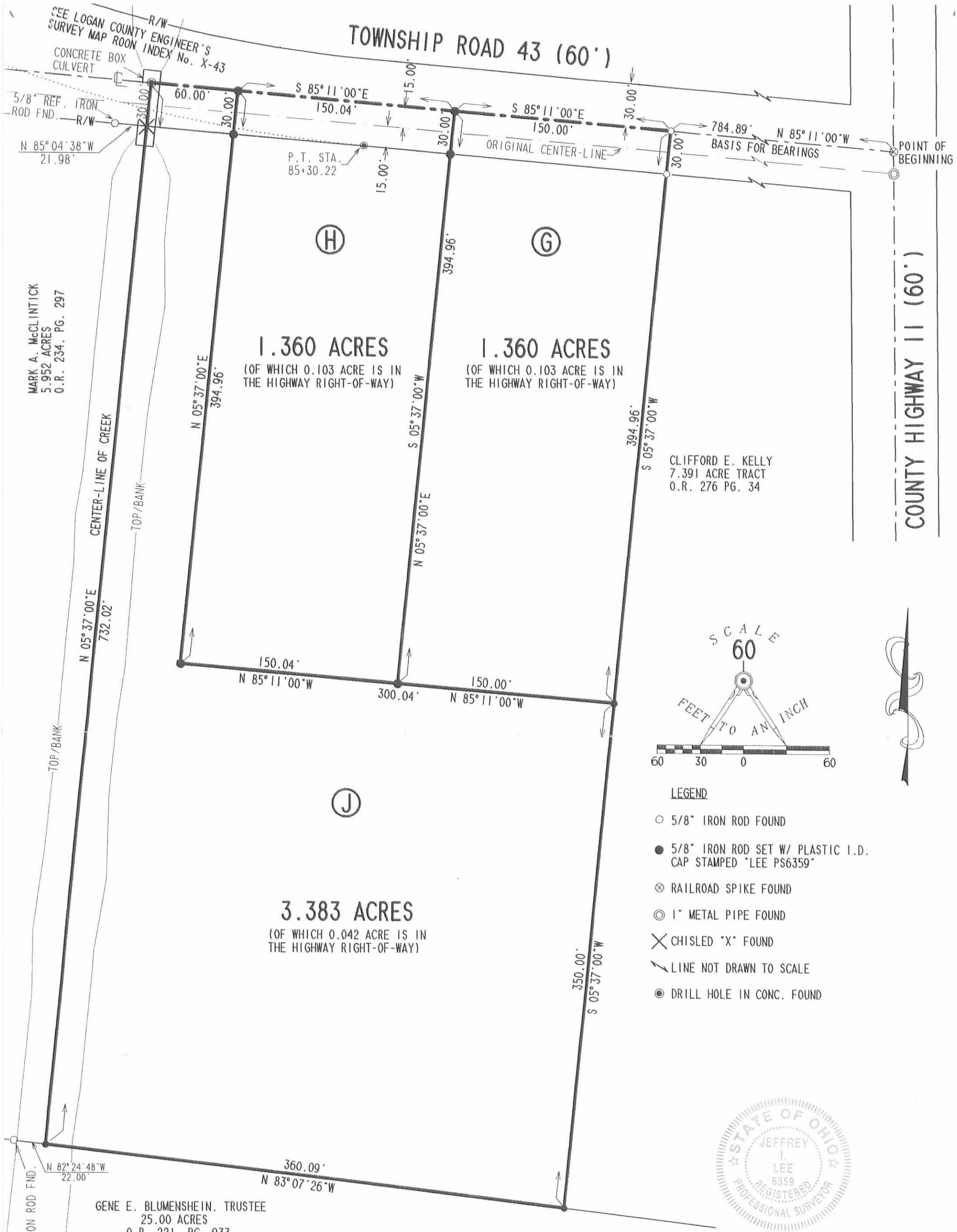

MARK A. McCLINTICK
5.952 ACRES
O.R. 234. PG. 297

1.360 ACRES
(OF WHICH 0.103 ACRE IS IN
THE HIGHWAY RIGHT-OF-WAY)

1.360 ACRES
(OF WHICH 0.103 ACRE IS IN
THE HIGHWAY RIGHT-OF-WAY)

3.383 ACRES
(OF WHICH 0.042 ACRE IS IN
THE HIGHWAY RIGHT-OF-WAY)

CLIFFORD E. KELLY
7.391 ACRE TRACT
O.R. 276 PG. 34

GENE E. BLUMENSHEIN, TRUSTEE
25.00 ACRES
O.R. 221. PG. 933

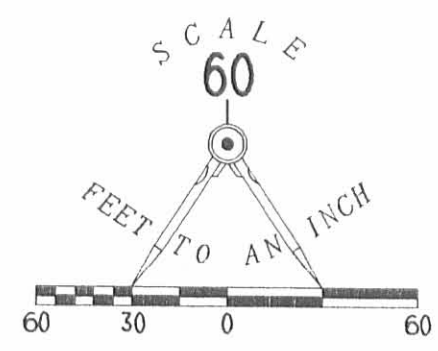

LEGEND

- 5/8" IRON ROD FOUND
- 5/8" IRON ROD SET W/ PLASTIC I.D. CAP STAMPED "LEE PS6359"
- ⊗ RAILROAD SPIKE FOUND
- ⊙ 1" METAL PIPE FOUND
- ✕ CHISELED "X" FOUND
- ↗ LINE NOT DRAWN TO SCALE
- DRILL HOLE IN CONC. FOUND



ORIGINAL STAMP IN GREEN

**SURVEY OF THREE TRACTS
OUT OF THE
CLIFFORD E. KELLY 6.103 ACRE TRACT
OFFICIAL RECORD 276. PAGE 36
SECTION 31. TOWN 3. RANGE 14
PLEASANT TOWNSHIP
LOGAN COUNTY, OHIO**

SURVEYED BY

Jeffrey I. Lee
JEFFREY I. LEE
PROFESSIONAL SURVEYOR 6359
APRIL 1, 1996

COPYRIGHT 1996 BY:

LEE SURVEYING & MAPPING CO., INC.
143 East Columbus Avenue
BELLEFONTAINE, OHIO 43311
(513) 593-7335

2 WORKING DAYS
BEFORE YOU DIG
CALL TOLL FREE **800-362-2764**
OHIO UTILITIES PROTECTION SERVICE.

INDEXED ON MAP
9100 2P D-281

CDKELLY5 L-2248-2

REC'D 10-2-96 [Signature] OK ✓



Lee Surveying and Mapping Co., Inc.



Farm Surveys • Lot Surveys • Topography • Subdivisions • Construction Layout

117 North Madriver Street
Bellefontaine, Ohio 43311

Phone (937) 593-7335
Fax (937) 593-7444

CLIFFORD E. KELLY TRACT K 1.405 ACRES

Lying in Section 31, Town 3, Range 14, Pleasant Township, Logan County, Ohio.

Being out of the Clifford E. Kelly and Mary Jane Kelly original 7.391 acre tract as deeded and described in Official Record 276, Page 34 of the Logan County Records of Deeds and being more particularly described as follows:

Beginning at a railroad spike found at the intersection of center-lines of Township Road 43 and County Highway 11.

THENCE, with the center-line of Township Road 43, N 85°-11'-00" W, a distance of 569.87 feet to a 3/4 inch iron rod set at the TRUE POINT OF BEGINNING.

THENCE, S 5°-37'-00" W, a distance of 394.96 feet to a 3/4 inch iron rod set.

THENCE, N 85°-11'-00" W, a distance of 155.02 feet to a 3/4 inch iron rod set.

THENCE, N 5°-37'-00" E, a distance of 394.96 feet to a 3/4 inch iron rod set.

THENCE, with the center-line of Township Road 43 (60 feet wide), S 85°-11'-00" E, a distance of 155.02 feet to the point of beginning.

Containing 1.405 acres of which 0.107 acre is within the highway right-of-way.

The basis for bearings is the center-line of Township Road 43 being S 85°-11'-00" E, and all other bearings are from angles and distances measured in a field survey by Lee Surveying and Mapping Company on September 26, 1996.

Description prepared by:

Jeffrey I. Lee
Professional Surveyor 6359
October 1, 1996

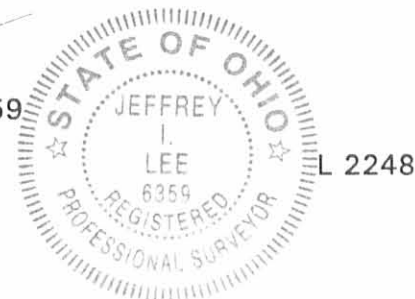

ORIGINAL STAMP IN GREEN

INDEXED ON MAP
9100 3D-1

REC ID 10-2-916 5/16/96 OK ✓



Lee Surveying and Mapping Co., Inc.



Farm Surveys • Lot Surveys • Topography • Subdivisions • Construction Layout

117 North Madriver Street
Bellefontaine, Ohio 43311

Phone (937) 593-7335
Fax (937) 593-7444

CLIFFORD E. KELLY TRACT L 1.405 ACRES

Lying in Section 31, Town 3, Range 14, Pleasant Township, Logan County, Ohio.

Being out of the Clifford E. Kelly and Mary Jane Kelly original 7.391 acre tract as deeded and described in Official Record 276, Page 34 of the Logan County Records of Deeds and being more particularly described as follows:

Beginning at a railroad spike found at the intersection of center-lines of Township Road 43 and County Highway 11.

THENCE, with the center-line of Township Road 43, N 85°-11'-00" W, a distance of 414.85 feet to a 3/4 inch iron rod set at the TRUE POINT OF BEGINNING.

THENCE, with the west lines of the Clifford E. Kelly 1.475 acre tract (O.R. 276, Pg. 26), the James A. Schienda 1.516 acre tract (O.R. 295, Pg. 753), and the Clifford E. Kelly 1.509 acre tract (O.R. 276, Pg. 30), S 5°-37'-00" W, a distance of 394.96 feet to a 3/4 inch iron rod set.

THENCE, N 85°-11'-00" W, a distance of 155.02 feet to a 3/4 inch iron rod set.

THENCE, N 5°-37'-00" E, a distance of 394.96 feet to a 3/4 inch iron rod set.

THENCE, with the center-line of Township Road 43 (60 feet wide), S 85°-11'-00" E, a distance of 155.02 feet to the point of beginning.

Containing 1.405 acres of which 0.107 acre is within the highway right-of-way.

The basis for bearings is the center-line of Township Road 43 being S 85°-11'-00" E, and all other bearings are from angles and distances measured in a field survey by Lee Surveying and Mapping Company on September 26, 1996.

Description prepared by:

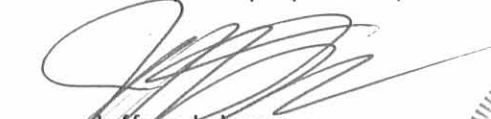
Jeffrey I. Lee
Professional Surveyor 6359
October 1, 1996

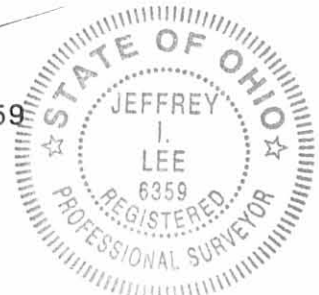

L 2248

ORIGINAL STAMP IN GREEN

INDEXED ON MAP
9100 3D-2

REC'D 10-8-96 SKY OK ✓



Lee Surveying and Mapping Co., Inc.



Farm Surveys • Lot Surveys • Topography • Subdivisions • Construction Layout

117 North Madriver Street
Bellefontaine, Ohio 43311

(513) 593-7335
FAX (513) 593-7444

CLIFFORD E. KELLY TRACT M 1.049 ACRES

Lying in Section 31, Town 3, Range 14, Pleasant Township, Logan County, Ohio.

Being out of the Clifford E. Kelly and Mary Jane Kelly original 7.391 acre tract as deeded and described in Official Record 276, Page 34 of the Logan County Records of Deeds and being more particularly described as follows:

Beginning at a 1 inch metal pipe found at the intersection of center-lines of County Highway 43 and County Highway 11.

THENCE, with the center-line of County Highway 11, S 0°24'50"E, a distance of 22.34 feet to a 1/2 inch iron rod found.

THENCE, with the center-line of County Highway 11 (60 feet wide), S 35°-21'-36" W, a distance of 272.20 feet to a railroad spike found at the TRUE POINT OF BEGINNING.

THENCE, with the center-line of County Highway 11, S 35°-21'-36" W, a distance of 189.19 feet to a railroad spike found.

THENCE, with the north line of the Lois M. Blumenshein, Trustee, 25.00 acre tract (O.R. 221, Pg. 933), N 83°-07'-26" W, a distance of 248.25 feet to a 3/4 inch iron rod set.

THENCE, N 14°-04'-00" E, a distance of 158.99 feet to a 5/8 inch iron rod found.

THENCE, with the south line of the Clifford E. Kelly 1.245 acre tract (O.R. 276, Pg. 32), S 84°-39'-42" E, a distance of 318.69 feet to the point of beginning.

Containing 1.049 acres of which 0.130 acre is within the highway right-of-way.

The basis for bearings is the center-line of Township Road 43 being S 85°-11'-00" E, and all other bearings are from angles and distances measured in a field survey by Lee Surveying and Mapping Company on September 26, 1996.

Description prepared by:

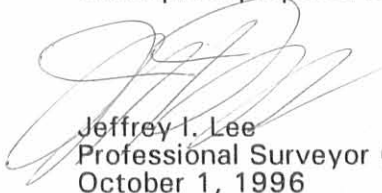
Jeffrey I. Lee
Professional Surveyor 6359
October 1, 1996



L 2248

ORIGINAL STAMP IN GREEN

INDEXED ON MAP
9100 3D-3



Lee Surveying and Mapping Co., Inc.



Farm Surveys • Lot Surveys • Topography • Subdivisions • Construction Layout

117 North Madriver Street
Bellefontaine, Ohio 43311

(513) 593-7335
FAX (513) 593-7444

CLIFFORD E. KELLY TRACT N 3.531 ACRES

Lying in Section 31, Town 3, Range 14, Pleasant Township, Logan County, Ohio.

Being out of the Clifford E. Kelly and Mary Jane Kelly original 7.391 acre tract as deeded and described in Official Record 276, Page 34 of the Logan County Records of Deeds and being more particularly described as follows:

Beginning at a 1 inch metal pipe found at the intersection of center-lines of County Highway 43 and County Highway 11.

THENCE, with the center-line of County Highway 11, S 0°24'50"E, a distance of 22.34 feet to a 1/2 inch iron rod found.

THENCE, with the center-line of County Highway 11, S 35°-21'-36" W, a distance of 461.39 feet to a railroad spike found.

THENCE, with the north line of the Lois M. Blumenshein, Trustee, 25.00 acre tract (O.R. 221, Pg. 933), N 83°-07'-26" W, a distance of 248.25 feet to a 3/4 inch iron rod set at the TRUE POINT OF BEGINNING.

THENCE, with the north line of the said 25.00 acre tract, N 83°-07'-26" W, a distance of 346.72 feet to a 5/8 inch iron rod found.

THENCE, with the east lines of the Clifford E. Kelly 3.383 acre tract (O.R. 300, Pg. 648) and 1.360 acre tract (O.R. 300, Pg. 646), N 5°-37'-00" E, a distance of 744.96 feet to a 5/8 inch iron rod found.

THENCE, with the center-line of Township Road 43 (60 feet wide), S 85°-11'-00" E, a distance of 60.00 feet to a 3/4 inch iron rod set.

THENCE, S 5°-37'-00" W, a distance of 394.96 feet to a 3/4 inch iron rod set.

THENCE, S 85°-11'-00" E, a distance of 310.04 feet to a 3/4 inch iron rod set.

THENCE, with the west lines of the Clifford E. Kelly 1.509 acre tract (O.R. 276, Pg. 30) and 1.245 acre tract (O.R. 276, Pg. 32), S 5°-37'-00" W, a distance of 205.52 feet to a 5/8 inch iron rod found.

THENCE, S 14°-04'-00" W, a distance of 158.99 feet to the point of beginning.

Containing 3.531 acres of which 0.041 acre is within the highway right-of-way.

The basis for bearings is the center-line of Township Road 43 being S 85°-11'-00" E, and all other bearings are from angles and distances measured in a field survey by Lee Surveying and Mapping Company on September 26, 1996.

Description prepared by:

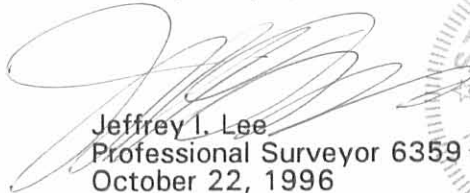
Jeffrey I. Lee
Professional Surveyor 6359
October 22, 1996



INDEXED ON MAP
9100 3D-4

L 2248

ORIGINAL STAMP IN GREEN

SEE LOGAN COUNTY ENGINEER'S MAP ROOM SURVEY INDEX NUMBER X-43
CONCRETE BOX CULVERT

TOWNSHIP ROAD 43 (60')

MARK A. McCLINTICK
5.952 ACRES
O.R. 234, PG. 297

CENTER-LINE OF CREEK
TOP BANK

TRACT H

TRACT G
CLIFFORD E. KELLY
1.360 ACRES
O.R. 300, PG. 646

TRACT K
1.405 ACRES
OF WHICH 0.107 ACRE IS WITHIN
THE HIGHWAY RIGHT-OF-WAY

TRACT L
1.405 ACRES
OF WHICH 0.107 ACRE IS WITHIN
THE HIGHWAY RIGHT-OF-WAY

TRACT A
CLIFFORD E. KELLY
1.475 ACRES
O.R. 276, PG. 26

TRACT B
JAMES A. SCHIENDA
1.516 ACRES
O.R. 295, PG. 753

TRACT C
CLIFFORD E. KELLY
1.509 ACRES
O.R. 276, PG. 30

TRACT J
CLIFFORD E. KELLY
3.383 ACRES
O.R. 300, PG. 648

TRACT N
3.531 ACRES
OF WHICH 0.041 ACRE IS WITHIN
THE HIGHWAY RIGHT-OF-WAY

TRACT D
CLIFFORD E. KELLY
1.245 ACRES
O.R. 276, PG. 32

TRACT M
1.049 ACRES
OF WHICH 0.130 ACRE IS WITHIN
THE HIGHWAY RIGHT-OF-WAY

LAWRENCE KNIGHT
86 ACRES
O.R. 181, PG. 700

LOIS M. BLUMENSHEIN, TRUSTEE
25.00 ACRES
O.R. 221, PG. 933

REFERENCES

LOGAN COUNTY ENGINEER'S FIELD BOOK 619, PAGE 15, AND BOOK 615, PAGES 77 AND 78.
LOGAN COUNTY ENGINEER'S MAP ROOM SURVEY INDEX NUMBER X-43.
PREVIOUS SURVEY OF SIX TRACTS BY LEE SURVEYING AND MAPPING COMPANY DATED 12/08/94.
FILE NO. L-2248-1.

INDEXED ON MAP
9100 3P

STA. 86+00
11.67' BELOW SURFACE,
SET P.K. STRADDLERS

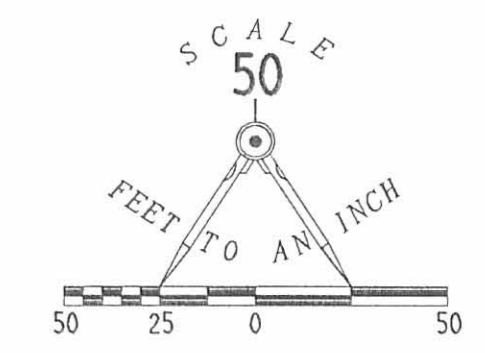
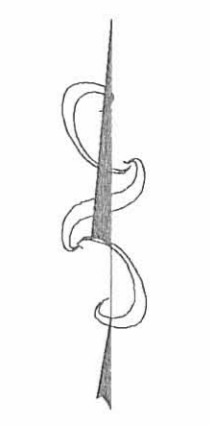

LEGEND

- 3/4" IRON ROD SET W/ PLASTIC I.D. CAP STAMPED "LEE P56359"
- 1" METAL PIPE FOUND
- 5/8" IRON ROD FOUND
- ⊗ RAILROAD SPIKE FOUND
- ⊙ CONCRETE R/W MONUMENT FOUND
- 1/2" IRON ROD FOUND

COUNTY HIGHWAY 43

SURVEY OF FOUR TRACTS OUT OF THE
CLIFFORD E. KELLY
ORIGINAL 7.391 ACRE TRACT
OFFICIAL RECORD 276, PAGE 34
SECTION 31, TOWN 3, RANGE 14
PLEASANT TOWNSHIP
LOGAN COUNTY, OHIO

SURVEYED BY:

Jeffrey L. Lee
JEFFREY L. LEE
PROFESSIONAL SURVEYOR 6359
SEPTEMBER 26, 1996



COPYRIGHT 1995 BY:
LEE SURVEYING & MAPPING CO.
143 East Columbus Avenue
BELLEFONTAINE, OHIO 43311
(613) 593-7335
D 290 CDKELLY6 L-2248-1

ORIGINAL STAMP IN GREEN

2 WORKING DAYS
BEFORE YOU DIG
CALL TOLL FREE 800-362-2764
OHIO UTILITIES PROTECTION SERVICE.

RECEIVED 6/11/93 ✓ MAP ROOM

**Lawrence Knight et al Survey
5.952 Acre Tract**

The following described real estate situated in the Township of Pleasant, County of Logan, State of Ohio and being a part of Section No. 31, Town 3, Range 14, Between the Miami Rivers Survey and being out of an original 86.00 Acre tract in the name of Lawrence Knight et al as recorded in Official Record No. 181 Page 700 (2-11-1993) and being more particularly described as follows:

Beginning for reference at a ReSurvey Monument in a Monument Box found at the Section Corner marking the northeast corner to Section No. 1, Town 2, Range 14 and the southeast corner to Section No. 2, Town 2, Range 14 and the southwest corner to Section No. 32, Town 3, Range 14 and the northwest corner to Section No. 31, Town 3, Range 14 and being Station No. 79+81.00 of the centerline survey of T. R. No. 43 as recorded in Logan County Engineers Field Book No. 615 Page 77 and being in the west line of Knight's tract;

Thence with the line between Section No. 1 and Section No. 31, S. 5°14'00" W. 247.78 feet to a 5/8" x 30" Rebar set at an extension of the east-west centerline of T. R. No. 43 and being the true place of beginning for this survey;

Thence with the extension of said east-west centerline and the centerline of T. R. No. 43 as shown on the 1937 Dedication Plan No. X-43 Page 2 (11-19-1937), S. 85°11'00" E. 360.02 feet to a Chisel Point in the center of a Concrete Box Culvert set, passing through a 5/8" x 30" Rebar set at 20.16 feet and a 5/8" x 30" Rebar set at 337.96 feet, (Note: The centerline of T. R. No. 43 is the Basis of Bearing for this survey - S. 85°11'00" E.);

Thence with the apparent centerline of a creek, S. 5°39'00" W. 731.76 feet to a point in the north line of Gene E. Blumenschein's present 25.00 Acre tract as recorded in Official Record No. 221 Page 933 (2-1-1994), (Note: A monumented base line is parallel with and 22.00 feet west of the center of said creek);

Thence with the line between Blumenschein and Knight, N. 83°12'44" W. 354.76 feet to a 5/8" x 30" Rebar set on the west side of a Large Concrete Post that is badly leaning on the line between Sections No. 31 and 1, which is the east line of Gene E. Blumenschein's present 35.85 Acre tract as recorded in Official Record No. 221 Page 933 (2-1-1994), passing through a 5/8" x 30" Rebar set at 22.00 feet;

INDEXED ON MAP
9100 4D-1

(2)

Thence with said Section Line, N. 5°14'00" E. 719.50 feet to the true place of beginning, passing the west side of a Large Concrete Post at 689.50 feet, containing 259,289.825 square feet or 5.952 Acres, more or less.

The above described tract is out of a 59.260 Acre tract as shown on the Logan County Auditors Tax Duplicate

Of the above described tract, there is 10,797.30 square feet or 0.246 Acres in the right of way of T. R. No. 43.

I hereby certify that this description is the result of a field survey made by me on June 15, 1994.



Daniel E. Gilbert
DANIEL E. GILBERT, P.S.
REG. SUR. NO. 5402
400 N. PARK ST.
BELLEFONTAINE, OHIO 43311
TELEPHONE: 1 (513) 593-1428

INDEXED ON MAP
9/100 4D-2

N. 5°-44'-00" E. 247.78'
to a ReSurvey Monument in
Monument Box found at
Section Corner.

Large Concrete
Corner Post Fd.

Chisel Point in center of
Concrete Box Culvert Set.

T.R. No. 43
Basis of Bearing

New Centerline - 1937 Dedication (See Plan X-43 Page 2, 11-19-1937).
Old Centerline
F.B. 615 P. 77-78.

259,289.825^{sq}
or
5.952 Acres

Lawrence Knight et al
O.R. No. 181 P. 700 (2-11-1993)
34-103-00-00-029.000

59.260 Acres
- 5.952 Acres
53.308 Acres

Gene E. Blumenschein, Trustee et al
O.R. No. 221 P. 933 (2-1-1994)
34-103-00-00-030.000
35,850 Acres
(35.00 Acres)

Sec. 1 T.2 R.14
Sec. 31 T.3 R.14

N. 5°-14'-00" E.

689.50'

719.50'

S. 5°-39'-00" W.
Traverse

S. 5°-39'-00" W.

731.00'

731.76'

731.00'

360.02'

N. 83°-12'-44" W.

332.76'

354.76'

Large Concrete Post Fd.
Leaning badly, set
5/8" x 30" Rebar
on west side of post.

Gene E. Blumenschein, Trustee et al
O.R. No. 221 P. 933 (2-1-1994)
34-103-00-00-031.000

25.000 Acres



INDEXED ON MAP
9100 4P



Scale: 1"=100'

- SYMBOLS:
- - 5/8" x 30" Rebar Fd.
 - - 5/8" x 30" Rebars Set.
 - - Tacked Wooden Hubs Fd.

Lawrence Knight et al Survey Section No. 31, Town 3, Range 14, B.M.R.S. Pleasant Township, Logan County, Ohio.		
SCALE: 1"=100'	APPROVED BY:	DRAWN BY DEG
DATE: 6-15-1994		REVISED
 Daniel E. Gilbert, P.S. Reg. Sur. No. 5402		DRAWING NUMBER 094-033