



Lee Surveying and Mapping Co., Inc.



Farm Surveys • Lot Surveys • Topography • Subdivisions • Construction Layout

117 NORTH MADRIVER STREET
BELLEFONTAINE, OHIO 43311

(937) 593-7335
FAX (937) 593-7444

LININGER 92.257 ACRES

Lying in Virginia Military Surveys 3163 and 12256, Allen Township, Union County, and Zane Township, Logan County.

Being out of the H. Cleon Lininger, Geraldine L. Lininger, Douglas A. Lininger, and Paul H. Lininger original 65.42 acre and original 120.57 acre tracts as deeded and described in Parcel 1, Tracts I and II of Volume 373, Page 614 of the Logan County Records of Deeds and Volume 274, Page 648 of the Union County Records of Deeds and being more particularly described as follows:

Beginning at a 1 inch iron pipe found on the center-line of Logan County Highway 153 at the southeast corner of Virginia Military Survey 12256.

THENCE, with the center-line of County Highway 153 (60 feet wide), S 81°-06'-55" W, a distance of 189.42 feet to a MAG nail set at the TRUE POINT OF BEGINNING.

THENCE, with the west lines of the Ohio Ready Mix 3.290 acre tract (Logan County O.R. 139, Pg. 888), the Charlotte A McCreary, Trustee original 145.0 acre tract (Union County Vol. 333, Pg. 674, Tr. I), and the James E. Nye and Mary K. Nye original 30.20 acre tract (Union County Vol. 223, Pg. 137), S 32°-33'-41" E, a distance of 3719.63 feet to a 5/8 inch iron rod set, passing a 5/8 inch iron rod set on the right-of-way of County Highway 153 at 32.75 feet, a 5/8 inch iron rod set on the northeast corner of Virginia Military Survey 3163 at 76.70 feet, and passing into Union County at 702.61 feet.

THENCE, with the northerly line of the R. Michael Funderburgh and Sandra E. Funderburgh original 150.0 acre tract (Union County Vol. 303, Pg. 19), S 56°-09'-39" W, a distance of 1003.41 feet to a point in the center of Big Darby Creek referenced by a 5/8 inch iron rod set S 56°-09'-39" W, a distance of 35.00 feet.

THENCE, with the center-line of the Big Darby Creek the following seventeen courses:

N 13°-50'-24" W, a distance of 116.05 feet to a point referenced by a 5/8 inch iron rod set S 77°-26'-58" W, a distance of 30.00 feet.

N 27°-17'-14" W, a distance of 215.62 feet to a point referenced by a 5/8 inch iron rod set S 63°-16'-01" W, a distance of 27.00 feet.

N 14°-25'-55" W, a distance of 49.94 feet to a point referenced by a 5/8 inch iron rod set S 71°-46'-54" W, a distance of 30.00 feet.

N 4°-29'-53" E, a distance of 129.62 feet to a point referenced by a 5/8 inch iron rod set N 88°-30'-30" W, a distance of 35.00 feet.

N 16°-55'-11" E, a distance of 304.01 feet to a point referenced by a 5/8 inch iron rod set N 70°-39'-51" W, a distance of 20.50 feet.

N 4°-50'-37" W, a distance of 203.78 feet to a point referenced by a 5/8 inch iron rod set S 76°-46'-09" W, a distance of 47.00 feet.

N 49°-42'-52" W, a distance of 151.90 feet to a point referenced by a 5/8 inch iron rod set S 39°-15'-39" W, a distance of 40.00 feet.

N 88°-38'-51" W, a distance of 194.99 feet to a point referenced by a 5/8 inch iron rod set S 2°-52'-56" W, a distance of 27.00 feet.

INDEXED ON MAP
74B 1D-1

N 60°-54'-59" W, a distance of 103.42 feet to a point reference by a 5/8 inch iron rod set
S 22°-38'-55" W, a distance of 37.00 feet.

N 47°-05'-47" W, a distance of 186.05 feet to a point reference by a 5/8 inch iron rod set
S 43°-41'-03" W, a distance of 32.00 feet.

N 56°-07'-27" W, a distance of 132.73 feet to a point reference by a 5/8 inch iron rod set
S 27°-43'-10" W, a distance of 45.00 feet.

N 78°-42'-22" W, a distance of 167.22 feet to a point reference by a 5/8 inch iron rod set
S 25°-34'-25" W, a distance of 32.00 feet.

N 54°-44'-54" W, a distance of 191.02 feet to a point reference by a 5/8 inch iron rod set
S 34°-49'-36" W, a distance of 33.00 feet.

N 34°-30'-25" W, a distance of 117.92 feet to a point reference by a 5/8 inch iron rod set
S 53°-12'-58" W, a distance of 36.00 feet.

N 23°-45'-50" W, a distance of 228.23 feet to a point reference by a 5/8 inch iron rod set
S 63°-49'-17" W, a distance of 45.00 feet.

N 44°-21'-57" W, a distance of 245.69 feet to a point reference by a 5/8 inch iron rod set
S 34°-25'-40" W, a distance of 38.00 feet.

N 51°-12'-33" W, a distance of 43.00 feet to a point.

THENCE, S 64°-06'-03" W, a distance of 315.80 feet to a 2 inch iron pipe found, passing
a 5/8 inch iron rod set at 47.50 feet.

THENCE, with the easterly lines of the Ronnie J. Wells and Judith A. Wells original 143.12
acre tract (Vol. 391, Pg. 386) and the Byron L. McBrayer 8.74 acre tract (O.R. 243, Pg. 275),
N 18°-31'-18" W, a distance of 1717.00 feet to a PK nail found, passing a 5/8 inch iron rod set
at 1686.96 feet.

THENCE, with the center-line of County Highway 153 the following two courses:

N 68°-37'-45" E, a distance of 266.21 feet to a 1 inch iron pipe found.

N 81°-06'-55" E, a distance of 812.21 feet to the point of beginning.

Containing 92.257 acres of which 0.628 acre is within the highway right-of-way; 46.190
acres are in Virginia Military Survey 3163 in Union County; 7.311 acres are in Virginia Military
Survey 12256 and 38.756 acres are in Virginia Military Survey 3163 in Logan County.

The basis for bearings is the center-line of County Highway 153 at the northeast corner of
the subject property is N 81°-06'-55" E, and all other bearings are from angles and distances
measured in a field survey by Lee Surveying and Mapping Co., Inc. on April 29, 1997.

Description prepared by:

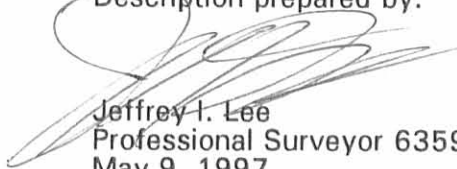

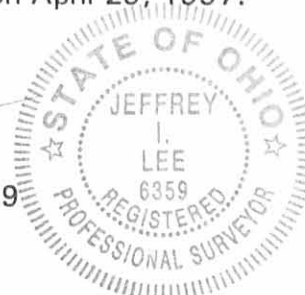
Jeffrey I. Lee
Professional Surveyor 6359
May 9, 1997

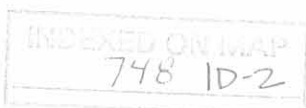

L 2522

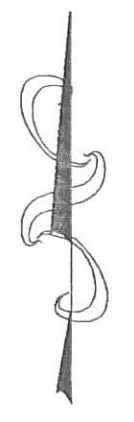
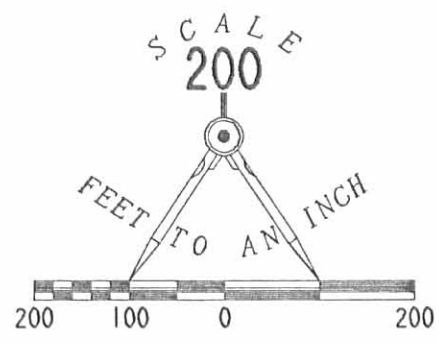

ORIGINAL STAMP IN GREEN



VIRGINIA MILITARY SURVEY 4606
VIRGINIA MILITARY SURVEY 12256

VIRGINIA MILITARY SURVEY 4606
COUNTY HIGHWAY 168 (60') STOKES ROAD
VIRGINIA MILITARY SURVEY 4880

SURVEY OF 92.257 ACRES OUT OF THE
H. CLEON LININGER,
GERALDINE L. LININGER,
DOUGLAS A. LININGER
AND
PAUL H. LININGER
PARCEL I, TRACTS I AND II OF
VOLUME 373, PAGE 614 (LOGAN COUNTY)
AND
VOLUME 274, PAGE 648 (UNION COUNTY)
VIRGINIA MILITARY SURVEYS 3163 AND 12256
ZANE TOWNSHIP, LOGAN COUNTY
AND
ALLEN TOWNSHIP, UNION COUNTY

92.257 ACRES
OF WHICH 0.628 ACRE
IS WITHIN THE HIGHWAY
RIGHT-OF-WAY

BYRON L. McBRAYER & SUSAN D. McBRAYER
8.74 AC.
O. R. 243, PG. 275

VIRGINIA MILITARY SURVEY 12256
VIRGINIA MILITARY SURVEY 3163

RONNIE J. WELLS & JUDITH A. WELLS
ORIG. 143.12 AC.
VOL. 391, PG. 386

H. CLEON LININGER, ETAL
ORIG. 65.42 AC.

H. CLEON LININGER, ETAL
ORIG. 120.57 AC.

CHARLOTTE A. McCREARY, TRUSTEE
ORIG. 145 AC.
VOL. 333, PG. 674, TR. I
(UNION CO. REF.)

JAMES E. NYE & MARY K. NYE
ORIG. 30.20 AC.
VOL. 223, PG. 137
(UNION CO. REF.)

JAMES R. CRAIG & PATRICIA E. CRAIG
1.01 AC.
VOL. 386, PG. 489

GREGORY A. CRINER &
CHRISTIANE M. CRINER
1.540 AC.
O. R. 193, PG. 29

CHARLES P. MALLY
1.625 AC.
O. R. 227, PG. 547

COLUMBUS NEWELL
2.00 AC.
O. R. 169, PG. 249

JOHANNES J. von LOTTUM & DIRKJE von LOTTUM
3.00 AC.
O. R. 206, PG. 79

R. MICHAEL FUNDERBURGH & SANDRA E. FUNDERBURGH
ORIG. 150 AC.
VOL. 303, PG. 19
(UNION CO. REF.)

LEGEND

- 5/8 IRON ROD SET
- ⊙ MAG NAIL SET
- ⊗ RAILROAD SPIKE FOUND
- 5/8 IRON ROD FOUND
- 1" IRON PIPE FOUND
- ⊙ 2" IRON PIPE FOUND
- ⊗ PK NAIL FOUND
- ⊕ 3/4" SQ. IRON BAR FOUND
- ⊞ WOOD POST FOUND

2 WORKING DAYS
BEFORE YOU DIG
CALL TOLL FREE 800-362-2764
OHIO UTILITIES PROTECTION SERVICE.



SURVEYED BY:
Jeffrey T. Lee
JEFFREY T. LEE
PROFESSIONAL SURVEYOR 6359
APRIL 29, 1997

COPYRIGHT 1997 BY:
LEE SURVEYING & MAPPING CO., INC.
117 North Madriver Street
BELLEFONTAINE, OHIO 43311
(937) 593-7335

D312 LLLFARMS L-2522-1

INDEXED ON MAP
746 1P

REC'D 8-28-98 SMJ OKV



Lee Surveying and Mapping Co., Inc.



Land Surveys • Topography • Subdivisions • Construction Layout

117 N. Madriver Street
Bellefontaine OH 43311

Phone: (937) 593-7335
Fax: (937) 593-7444

LININGER TRACT A 9.205 ACRES

Lying in Virginia Military Surveys 3163 and 12256, Zane Township, Logan County, Ohio

Being out of the H. Cleon Lininger, Geraldine L. Lininger, Douglas A. Lininger, and Paul H. Lininger original 65.42 acre tract deeded and described in Parcel 1, Tract I of Volume 373, Page 614 of the Logan County Records of Deeds and Volume 274, Page 648 of the Union County Records of Deeds and being more particularly described as follows:

Beginning at a 1 inch iron pipe found on the center-line of Logan County Highway 153 at the southeast corner of Virginia Military Survey 12256.

THENCE, with the center-line of County Highway 153 (60 feet wide), S 81°-06'-55" W, a distance of 800.87 feet to a MAG nail set at the TRUE POINT OF BEGINNING.

THENCE, S 32°-33'-41" E, a distance of 650.00 feet to a 5/8 inch iron rod set, passing a 5/8 inch iron rod set at 32.75 feet.

THENCE, S 57°-26'-19" W, a distance of 640.61 feet to a 5/8 inch iron rod set on the east line of the Ronnie J. Wells original 143.12 acre tract, (Vol. 391, Pg. 386).

THENCE, with the east line of the said 143.12 acre tract, N 18°31'-18" W, a distance of 806.36 feet to a P.K. nail found on the center-line of County Highway 153, passing a 5/8 inch iron rod set at 776.32 feet.

THENCE, with the center-line of County Highway 153, N 68°-37'-45" E, a distance of 266.21 feet to a 1 inch iron pipe found.

THENCE, continuing with the center-line of County Highway 153, N 81°-06'-55" E, a distance of 200.76 feet to the point of beginning.

Containing 9.205 acres of which 0.324 acre is within the highway right-of-way, 4.733 acres are in Virginia Military Survey 12256 and 4.472 acre are in Virginia Military Survey 3163.

The basis for bearings is the center-line of County Highway 153 west of the south line of Virginia Military Survey 12256, being N 81°-06'-55" E, and all other bearings are from angles and distance measured in a field survey by Lee Surveying and Mapping Co., Inc. on July 22, 1998.

Description prepared by:

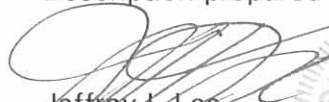
Jeffrey I. Lee
Professional Surveyor 6359
July 23, 1998



L-2522

ORIGINAL STAMP IN GREEN

INDEXED ON MAP
748 2D-1

REC'D 8-28-98 SMJ OK ✓



Lee Surveying and Mapping Co., Inc.



Land Surveys • Topography • Subdivisions • Construction Layout

117 N. Madriver Street
Bellefontaine OH 43311

Phone: (937) 593-7335
Fax: (937) 593-7444

LININGER TRACT B 6.384 ACRES

Lying in Virginia Military Surveys 3163 and 12256, Zane Township, Logan County, Ohio

Being out of the H. Cleon Lininger, Geraldine L. Lininger, Douglas A. Lininger, and Paul H. Lininger original 65.42 acre tract as deeded and described in Parcel 1, Tract I of Volume 373, Page 614 of the Logan County Records of Deeds and Volume 274, Page 648 of the Union County Records of Deeds and being more particularly described as follows:

Beginning at a 1 inch iron pipe found on the center-line of Logan County Highway 153 at the southeast corner of Virginia Military Survey 12256.

THENCE, with the center-line of County Highway 153 (60 feet wide), S 81°-06'-55" W, a distance of 713.52 feet to a MAG nail set at the TRUE POINT OF BEGINNING.

THENCE, S 32°-33'-41" E, a distance of 915.00 feet to a 5/8 inch iron rod set, passing a 5/8 inch iron rod set at 32.75 feet.

THENCE, S 57°-26'-19" W, a distance of 795.65 feet to a 5/8 inch iron rod set on the east line of the Ronnie J. Wells original 143.12 acre tract, (Vol. 391, Pg. 386).

THENCE, with the east line of the said 143.12 acre tract, N 18°-31'-18" W, a distance of 309.32 feet to a 5/8 inch iron rod set.

THENCE N 57°-26'-19" E, a distance of 640.61 feet to a 5/8 inch iron rod set.

THENCE, N 32°-33'-41" W, a distance of 650.00 feet to a MAG nail set on the center-line of County Highway 153, passing a 5/8 inch iron rod set at 617.25 feet.

THENCE, with the center-line of County Highway 153, N 81°-06'-55" E, a distance of 87.35 feet to the point of beginning.

Containing 6.384 acres of which 0.060 acre is within the highway right-of-way, 0.563 acre is in Virginia Military Survey 12256 and 5.821 acres are in Virginia Military Survey 3163.

The basis for bearings is the center-line of County Highway 153 west of the south line of Virginia Military Survey 12256, being N 81°-06'-55" E, and all other bearings are from angles and distance measured in a field survey by Lee Surveying and Mapping Co., Inc. on July 22, 1998.

Description prepared by:

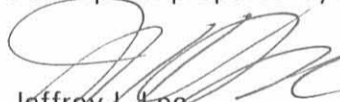
Jeffrey I. Lee
Professional Surveyor 6359
July 23, 1998

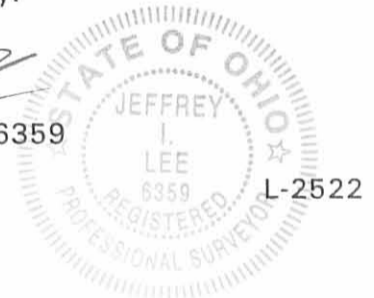

ORIGINAL STAMP IN GREEN

INDEXED ON MAP
748 2D-2

REC'D 6-28-98 SMY OK ✓



Lee Surveying and Mapping Co., Inc.



Land Surveys • Topography • Subdivisions • Construction Layout

117 N. Madriver Street
Bellefontaine OH 43311

Phone: (937) 593-7335
Fax: (937) 593-7444

LININGER TRACT C 8.816 ACRES

Lying in Virginia Military Surveys 3163 and 12256, Zane Township, Logan County, Ohio

Being out of the H. Cleon Lininger, Geraldine L. Lininger, Douglas A. Lininger, and Paul H. Lininger original 65.42 acre tract as deeded and described in Parcel 1, Tract I of Volume 373, Page 614 of the Logan County Records of Deeds and Volume 274, Page 648 of the Union County Records of Deeds and being more particularly described as follows:

Beginning at a 1 inch iron pipe found on the center-line of Logan County Highway 153 at the southeast corner of Virginia Military Survey 12256.

THENCE, with the center-line of County Highway 153 (60 feet wide), S 81°-06'-55" W, a distance of 626.17 feet to a MAG nail set at the TRUE POINT OF BEGINNING.

THENCE, S 32°-33'-41" E, a distance of 1220.00 feet to a 5/8 inch iron rod set, passing a 5/8 inch iron rod set at 32.75 feet.

THENCE, S 57°-26'-19" W, a distance of 960.69 feet to a 5/8 inch iron rod set on the east line of the Ronnie J. Wells original 143.12 acre tract, (Vol. 391, Pg. 386).

THENCE, with the east line of the said 143.12 acre tract, N 18°-31'-18" W, a distance of 350.55 feet to a 5/8 inch iron rod set.

THENCE N 57°-26'-19" E, a distance of 795.65 feet to a 5/8 inch iron rod set.

THENCE, N 32°-33'-41" W, a distance of 915.00 feet to a MAG nail set on the center-line of County Highway 153, passing a 5/8 inch iron rod set at 882.25 feet.

THENCE, with the center-line of County Highway 153, N 81°-06'-55" E, a distance of 87.35 feet to the point of beginning.

Containing 8.816 acres of which 0.060 acre is within the highway right-of-way, 0.498 acre is in Virginia Military Survey 12256 and 8.318 acres are in Virginia Military Survey 3163.

The basis for bearings is the center-line of County Highway 153 west of the south line of Virginia Military Survey 12256, being N 81°-06'-55" E, and all other bearings are from angles and distance measured in a field survey by Lee Surveying and Mapping Co., Inc. on July 22, 1998.

Description prepared by:

Jeffrey I. Lee
Professional Surveyor 6359
July 23, 1998

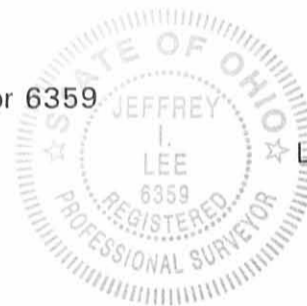

E-2522

ORIGINAL STAMP IN GREEN

INDEXED ON MAP
748 20-3

REC'D 8-28-98 SMY CLK ✓



Lee Surveying and Mapping Co., Inc.



Land Surveys • Topography • Subdivisions • Construction Layout

117 N. Madriver Street
Bellefontaine OH 43311

Phone: (937) 593-7335
Fax: (937) 593-7444

LININGER TRACT D 9.529 ACRES

Lying in Virginia Military Surveys 3163 and 12256, Allen Township, Union County, and Zane Township, Logan County, Ohio

Being out of the H. Cleon Lininger, Geraldine L. Lininger, Douglas A. Lininger, and Paul H. Lininger original 65.42 acre and original 120.57 acre tracts as deeded and described in Parcel 1, Tracts I and II of Volume 373, Page 614 of the Logan County Records of Deeds and Volume 274, Page 648 of the Union County Records of Deeds and being more particularly described as follows:

Beginning at a 1 inch iron pipe found on the center-line of Logan County Highway 153 at the southeast corner of Virginia Military Survey 12256.

THENCE, with the center-line of County Highway 153 (60 feet wide), S 81°-06'-55" W, a distance of 538.82 feet to a MAG nail set at the TRUE POINT OF BEGINNING.

THENCE, S 32°-33'-41" E, a distance of 1525.00 feet to a 5/8 inch iron rod set, passing a 5/8 inch iron rod set at 32.75 feet.

THENCE, S 61°-48'-20" W, a distance of 790.15 feet to a point on the center-line of the Big Darby Creek, passing a 5/8 inch iron rod set at 745.15 feet.

THENCE, S 64°-06'-03" W, a distance of 315.80 feet to a 2 inch iron pipe found on the southeasterly corner of the Ronnie J. Wells original 143.12 acre tract, (Vol. 391, Pg. 386), passing a 5/8 inch iron rod set at 47.50 feet.

THENCE, with the east line of the said 143.12 acre tract, N 18°-31'-18" W, a distance of 250.77 feet to a 5/8 inch iron rod set.

THENCE N 57°-26'-19" E, a distance of 960.69 feet to a 5/8 inch iron rod set.

THENCE, N 32°-33'-41" W, a distance of 1220.00 feet to a MAG nail set on the center-line of County Highway 153, passing a 5/8 inch iron rod set at 1187.25 feet.

THENCE, with the center-line of County Highway 153, N 81°-06'-55" E, a distance of 87.35 feet to the point of beginning.

Containing 9.529 acres of which 0.060 acre is within the highway right-of-way, 9.036 acres are in Logan County with 0.433 acre in Virginia Military Survey 12256 and 8.603 acre is in Virginia Military Survey 3163, and 0.493 acre is in Virginia Military Survey 3163 in Union County.

The basis for bearings is the center-line of County Highway 153 west of the south line of Virginia Military Survey 12256, being N 81°-06'-55" E, and all other bearings are from angles and distance measured in a field survey by Lee Surveying and Mapping Co., Inc. on July 22, 1998.

Description prepared by:

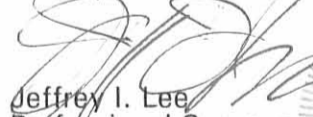

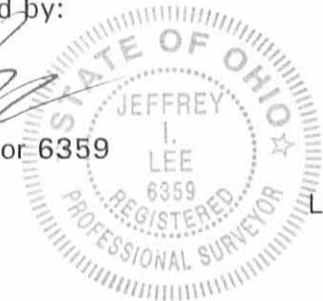
Jeffrey I. Lee
Professional Surveyor 6359
July 23, 1998



L-2522

ORIGINAL STAMP IN GREEN

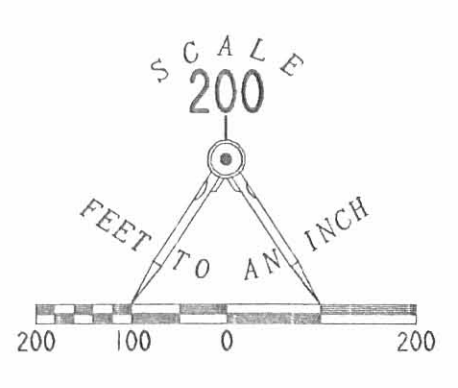
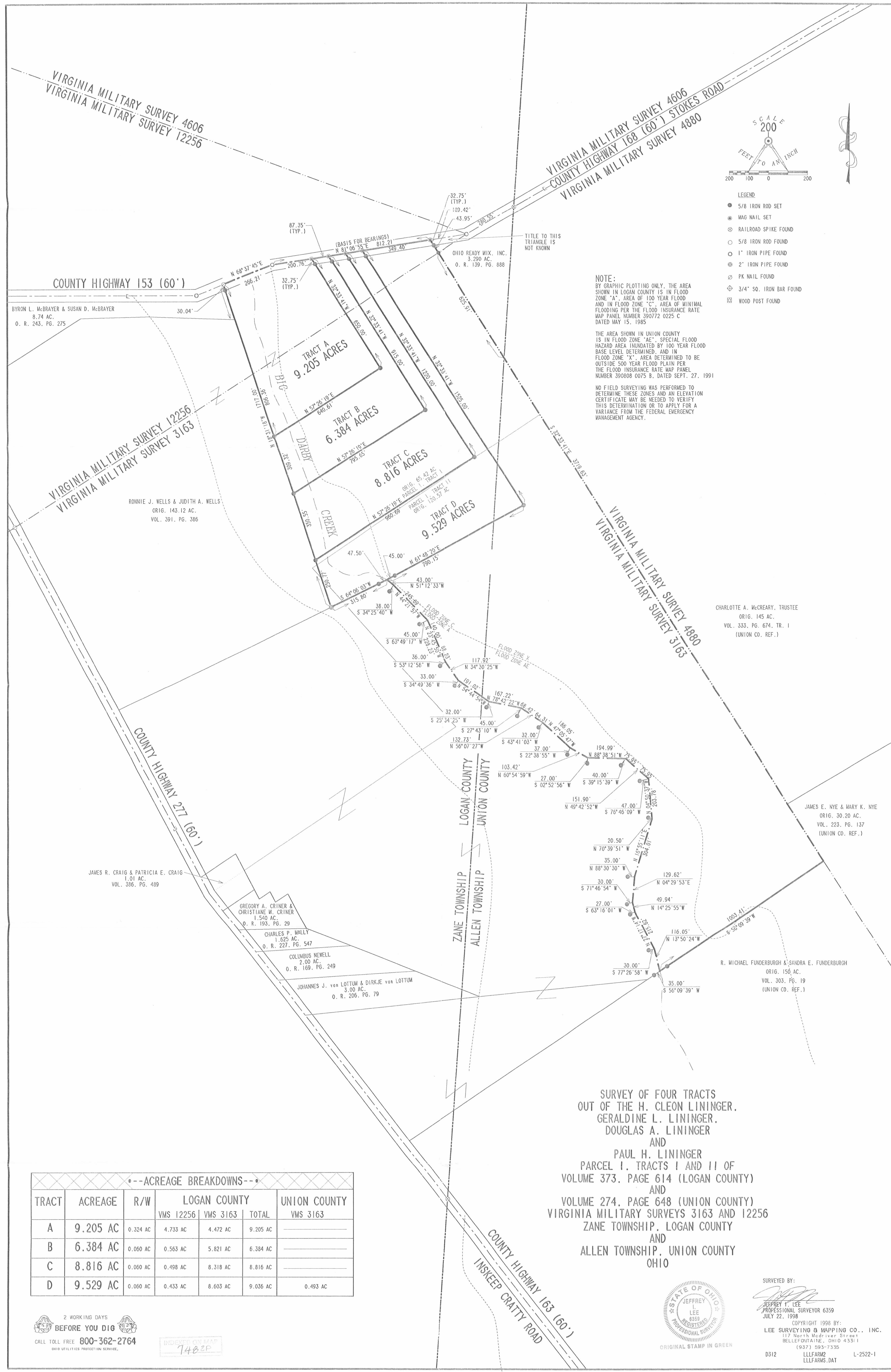
INDEXED ON MAP
748 2D-4



- LEGEND**
- 5/8 IRON ROD SET
 - ⊙ MAG NAIL SET
 - ⊗ RAILROAD SPIKE FOUND
 - 5/8 IRON ROD FOUND
 - 1" IRON PIPE FOUND
 - ⊗ 2" IRON PIPE FOUND
 - ⊙ PK NAIL FOUND
 - ⊕ 3/4" SQ. IRON BAR FOUND
 - ⊠ WOOD POST FOUND

NOTE:
 BY GRAPHIC PLOTTING ONLY, THE AREA SHOWN IN LOGAN COUNTY IS IN FLOOD ZONE "A", AREA OF 100 YEAR FLOOD AND IN FLOOD ZONE "C", AREA OF MINIMAL FLOODING PER THE FLOOD INSURANCE RATE MAP PANEL NUMBER 390772 0225 C DATED MAY 15, 1985
 THE AREA SHOWN IN UNION COUNTY IS IN FLOOD ZONE "AE", SPECIAL FLOOD HAZARD AREA INUNDATED BY 100 YEAR FLOOD BASE LEVEL DETERMINED, AND IN FLOOD ZONE "X", AREA DETERMINED TO BE OUTSIDE 500 YEAR FLOOD PLAIN PER THE FLOOD INSURANCE RATE MAP PANEL NUMBER 390808 0075 B, DATED SEPT. 27, 1991
 NO FIELD SURVEYING WAS PERFORMED TO DETERMINE THESE ZONES AND AN ELEVATION CERTIFICATE MAY BE NEEDED TO VERIFY THIS DETERMINATION OR TO APPLY FOR A VARIANCE FROM THE FEDERAL EMERGENCY MANAGEMENT AGENCY.

CHARLOTTE A. MCCREARY, TRUSTEE
 ORIG. 145 AC.
 VOL. 333, PG. 674, TR. 1
 (UNION CO. REF.)

JAMES E. NYE & MARY K. NYE
 ORIG. 30.20 AC.
 VOL. 223, PG. 137
 (UNION CO. REF.)

R. MICHAEL FUNDERBURGH & SANDRA E. FUNDERBURGH
 ORIG. 150 AC.
 VOL. 303, PG. 19
 (UNION CO. REF.)

**SURVEY OF FOUR TRACTS
 OUT OF THE H. CLEON LININGER,
 GERALDINE L. LININGER,
 DOUGLAS A. LININGER
 AND
 PAUL H. LININGER
 PARCEL I, TRACTS I AND II OF
 VOLUME 373, PAGE 614 (LOGAN COUNTY)
 AND
 VOLUME 274, PAGE 648 (UNION COUNTY)
 VIRGINIA MILITARY SURVEYS 3163 AND 12256
 ZANE TOWNSHIP, LOGAN COUNTY
 AND
 ALLEN TOWNSHIP, UNION COUNTY
 OHIO**

--ACREAGE BREAKDOWNS--

TRACT	ACREAGE	R/W	LOGAN COUNTY			UNION COUNTY
			VMS 12256	VMS 3163	TOTAL	
A	9.205 AC	0.324 AC	4.733 AC	4.472 AC	9.205 AC	
B	6.384 AC	0.060 AC	0.563 AC	5.821 AC	6.384 AC	
C	8.816 AC	0.060 AC	0.498 AC	8.318 AC	8.816 AC	
D	9.529 AC	0.060 AC	0.433 AC	8.603 AC	9.036 AC	0.493 AC

2 WORKING DAYS
BEFORE YOU DIG
 CALL TOLL FREE 800-362-2764
 OHIO UTILITIES PROTECTION SERVICE.

INDEXED ON MAP
 7482P

STATE OF OHIO
 JEFFREY L. LEE
 REGISTERED PROFESSIONAL SURVEYOR
 ORIGINAL STAMP IN GREEN

SURVEYED BY:
 JEFFREY L. LEE
 PROFESSIONAL SURVEYOR 6359
 JULY 22, 1998
 COPYRIGHT 1998 BY:
 LEE SURVEYING & MAPPING CO., INC.
 117 North Madriver Street
 BELLEFONTAINE, OHIO 43311
 (937) 593-7335
 D312 LLLFARM2 L-2522-1



Lee Surveying and Mapping Co., Inc.



Land Surveys • Topography • Subdivisions • Construction Layout

117 N. Madriver Street
Bellefontaine OH 43311

Phone: (937) 593-7335
Fax: (937) 593-7444

LININGER TRACT E 9.616 ACRES

Lying in Virginia Military Surveys 3163 and 12256, Allen Township, Union County, and Zane Township, Logan County, Ohio

Being out of the H. Cleon Lininger, Geraldine L. Lininger, Douglas A. Lininger, and Paul H. Lininger original 65.42 acre and original 120.57 acre tracts as deeded and described in Parcel 1, Tracts I and II of Volume 373, Page 614 of the Logan County Records of Deeds and Volume 274, Page 648 of the Union County Records of Deeds and being more particularly described as follows:

Beginning at a 1 inch iron pipe found on the center-line of Logan County Highway 153 at the southeast corner of Virginia Military Survey 12256.

THENCE, with the center-line of County Highway 153 (60 feet wide), S 81°-06'-55" W, a distance of 451.47 feet to a MAG nail set at the TRUE POINT OF BEGINNING.

THENCE, S 32°-33'-41" E, a distance of 1800.00 feet to a 5/8 inch iron rod set, passing a 5/8 inch iron rod set at 32.75 feet.

THENCE, S 54°-01'-02" W, a distance of 826.73 feet to a point on the center-line of the Big Darby Creek, passing a 5/8 inch iron rod set at 781.73 feet.

THENCE, with the center-line of the said creek, the following three courses:

N 23°-45'-50" W, a distance of 140.00 feet to a point referenced by a 5/8 inch iron rod set S 63°-49'-17" W, a distance of 45.00 feet.

N 44°-21'-57" W, a distance of 245.69 feet to a point referenced by a 5/8 inch iron rod set S 34°-25'-40" W, a distance of 38.00 feet.

N 51°-12'-33" W, a distance of 43.00 feet to a point.

THENCE, N 61°-48'-20" E, a distance of 790.15 feet to a 5/8 inch iron rod set, passing a 5/8 inch iron rod set at 45.00 feet.

THENCE, N 32°-33'-41" W, a distance of 1525.00 feet to a MAG nail set on the center-line of County Highway 153, passing a 5/8 inch iron rod set at 1492.25 feet.

THENCE, with the center-line of County Highway 153, N 81°-06'-55" E, a distance of 87.35 feet to the point of beginning.

Containing 9.616 acres of which 0.060 acre is within the highway right-of-way, 6.174 acres are in Logan County with 0.368 acre in Virginia Military Survey 12256 and 5.806 acres are in Virginia Military Survey 3163, and 3.442 acre is in Virginia Military Survey 3163 in Union County.

The basis for bearings is the center-line of County Highway 153 west of the south line of Virginia Military Survey 12256, being N 81°-06'-55" E, and all other bearings are from angles and distance measured in a field survey by Lee Surveying and Mapping Co., Inc. on July 22, 1998.

Description prepared by:

Jeffrey I. Lee
Professional Surveyor 6359
July 23, 1998



ORIGINAL STAMP IN GREEN

L-2522

INDEXED ON MAP
748 3D-1

REC'D 9-1-98 SWM OK ✓



Lee Surveying and Mapping Co., Inc.



Land Surveys • Topography • Subdivisions • Construction Layout

117 N. Madriver Street
Bellefontaine OH 43311

Phone: (937) 593-7335
Fax: (937) 593-7444

LININGER TRACT F 13.612 ACRES

Lying in Virginia Military Surveys 3163 and 12256, Allen Township, Union County, and Zane Township, Logan County, Ohio

Being out of the H. Cleon Lininger, Geraldine L. Lininger, Douglas A. Lininger, and Paul H. Lininger original 65.42 acre and original 120.57 acre tracts as deeded and described in Parcel 1, Tracts I and II of Volume 373, Page 614 of the Logan County Records of Deeds and Volume 274, Page 648 of the Union County Records of Deeds and being more particularly described as follows:

Beginning at a 1 inch iron pipe found on the center-line of Logan County Highway 153 at the southeast corner of Virginia Military Survey 12256.

THENCE, with the center-line of County Highway 153 (60 feet wide), S 81°-06'-55" W, a distance of 364.12 feet to a MAG nail set at the TRUE POINT OF BEGINNING.

THENCE, S 32°-33'-41" E, a distance of 2225.00 feet to a 5/8 inch iron rod set, passing a 5/8 inch iron rod set at 32.75 feet.

THENCE, S 45°-16'-26" W, a distance of 710.64 feet to a point on the center-line of the Big Darby Creek, passing a 5/8 inch iron rod set at 612.40 feet.

THENCE, with the center-line of said creek, the following five (5) courses:

N 56°-07'-27" W, a distance of 68.42 feet to a point referenced by a 5/8 inch iron set at S 27°-43'-10" W, a distance of 45.00 feet.

N 78°-42'-22" W, a distance of 167.22 feet to a point referenced by a 5/8 inch iron rod set S 25°-34'-25" W, a distance of 32.00 feet.

N 54°-44'-54" W, a distance of 191.02 feet to a point referenced by a 5/8 inch iron rod set S 34°-49'-36" W, a distance of 33.00 feet.

N 34°-30'-25" W, a distance of 117.92 feet to a point, referenced by a 5/8 inch iron rod set S 53°-12'-58" W, a distance of 36.00 feet.

N 23°-45'-50" W, a distance of 88.23 feet to a point.

THENCE, N 54°-01'-02" E, a distance of 826.73 feet to a 5/8 inch iron rod set, passing a 5/8 inch iron rod set at 45.00 feet.

THENCE, N 32°-33'-41" W, a distance of 1800.00 feet to a MAG nail set on the center-line of County Highway 153, passing a 5/8 inch iron rod set at 1767.25 feet.

THENCE, with the center-line of County Highway 153, N 81°-06'-55" E, a distance of 87.35 feet to the point of beginning.

Containing 13.612 acres of which 0.060 acre is within the highway right-of-way, 3.344 acres are in Logan County with 0.303 acre in Virginia Military Survey 12256 and 3.041 acres are in Virginia Military Survey 3163, and 10.268 acres are in Virginia Military Survey 3163 in Union County.

The basis for bearings is the center-line of County Highway 153 west of the south line of Virginia Military Survey 12256, being N 81°-06'-55" E, and all other bearings are from angles and distance measured in a field survey by Lee Surveying and Mapping Co., Inc. on July 22, 1998.

Description prepared by:

Jeffrey I. Lee
Professional Surveyor 6359

July 23, 1998
Rev. September 1, 1998

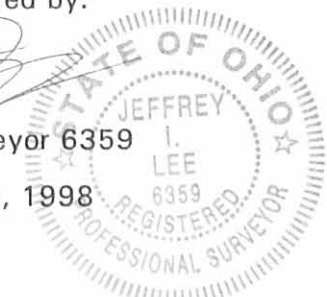

L-2522

ORIGINAL STAMP IN GREEN

INDEXED ON MAP
748 3D-2

REC'D 9-1-98 SMY OK



Lee Surveying and Mapping Co., Inc.



Land Surveys • Topography • Subdivisions • Construction Layout

117 N. Madriver Street
Bellefontaine OH 43311

Phone: (937) 593-7335
Fax: (937) 593-7444

LININGER TRACT G 12.655 ACRES

Lying in Virginia Military Surveys 3163 and 12256, Allen Township, Union County, and Zane Township, Logan County, Ohio

Being out of the H. Cleon Lininger, Geraldine L. Lininger, Douglas A. Lininger, and Paul H. Lininger original 65.42 acre and original 120.57 acre tracts as deeded and described in Parcel 1, Tracts I and II of Volume 373, Page 614 of the Logan County Records of Deeds and Volume 274, Page 648 of the Union County Records of Deeds and being more particularly described as follows:

Beginning at a 1 inch iron pipe found on the center-line of Logan County Highway 153 at the southeast corner of Virginia Military Survey 12256.

THENCE, with the center-line of County Highway 153 (60 feet wide), S 81°-06'-55" W, a distance of 276.77 feet to a MAG nail set at the TRUE POINT OF BEGINNING.

THENCE, S 32°-33'-41" E, a distance of 2750.00 feet to a 5/8 inch iron rod set, passing a 5/8 inch iron rod set at 32.75 feet.

THENCE, S 45°-16'-26" W, a distance of 479.72 feet to a point on the center-line of the Big Darby Creek, passing a 5/8 inch iron rod set at 434.72 feet.

THENCE, with the center-line of Big Darby Creek, the following five (5) courses:

N 49°-42'-52" W, a distance of 75.95 feet to a point referenced by a 5/8 inch iron rod set S 39°-15'-39" W, a distance of 40.00 feet.

N 88°-38'-51" W, a distance of 194.99 feet to a point referenced by a 5/8 inch iron rod set S 2°-52'-56" W, a distance of 27.00 feet.

N 60°-54'-59" W, a distance of 103.42 feet to a point referenced by a 5/8 inch iron rod set S 22°-38'-55" W, a distance of 37.00 feet.

N 47°-05'-47" W, a distance of 186.05 feet to a point referenced by a 5/8 inch iron rod set S 43°-41'-03" W, a distance of 32.00 feet.

N 56°-07'-27" W, a distance of 64.31 feet to a point.

THENCE, N 45°-16'-26" E, a distance of 710.64 feet to a 5/8 inch iron rod set, passing a 5/8 inch iron rod set at 98.24 feet.

THENCE, N 32°-33'-41" W, a distance of 2225.00 feet to a MAG nail set on the center-line of County Highway 153, passing a 5/8 inch iron rod set at 2192.25 feet.

THENCE, with the center-line of County Highway 153, N 81°-06'-55" E, a distance of 87.35 feet to the point of beginning.

Containing 12.655 acres of which 0.060 acre is within the highway right-of-way, 1.686 acres are in Logan County with 0.238 acre in Virginia Military Survey 12256 and 1.448 acres are Virginia Military Survey 3163, and 10.969 acres are in Virginia Military Survey 3163 in Union County.

The basis for bearings is the center-line of County Highway 153 west of the south line of Virginia Military Survey 12256, being N 81°-06'-55" E, and all other bearings are from angles and distance measured in a field survey by Lee Surveying and Mapping Co., Inc. on July 22, 1998.

Description prepared by:

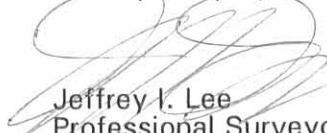
Jeffrey I. Lee

Professional Surveyor 6359
July 23, 1998
Rev. September 1, 1998

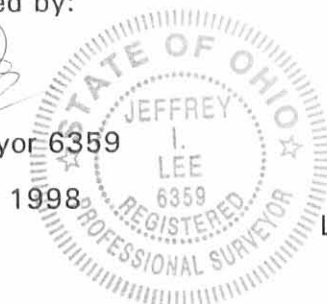

L-2522

ORIGINAL STAMP IN GREEN

INDEXED ON MAP
740 3D-3

REC'D 8-28-98 SWY ALL ✓



Lee Surveying and Mapping Co., Inc.



Land Surveys • Topography • Subdivisions • Construction Layout

117 N. Madriver Street
Bellefontaine OH 43311

Phone: (937) 593-7335
Fax: (937) 593-7444

LININGER TRACT H 22.440 ACRES

Lying in Virginia Military Surveys 3163 and 12256, Allen Township, Union County, and Zane Township, Logan County, Ohio

Being out of the H. Cleon Lininger, Geraldine L. Lininger, Douglas A. Lininger, and Paul H. Lininger original 65.42 acre and original 120.57 acre tracts as deeded and described in Parcel 1, Tracts I and II of Volume 373, Page 614 of the Logan County Records of Deeds and Volume 274, Page 648 of the Union County Records of Deeds and being more particularly described as follows:

Beginning at a 1 inch iron pipe found on the center-line of Logan County Highway 153 at the southeast corner of Virginia Military Survey 12256.

THENCE, with the center-line of County Highway 153 (60 feet wide), S 81°-06'-55" W, a distance of 189.42 feet to a MAG nail set at the TRUE POINT OF BEGINNING.

THENCE, with the west line of Virginia Military Survey 4880, the west lines of the Ohio Ready Mix 3.290 acre tract (Logan County O.R. 139, Pg. 888), the Charlotte A McCreary, Trustee original 145.0 acre tract (Union County Vol. 333, Pg. 674, Tr. I), and the James E. Nye and Mary K. Nye original 30.20 acre tract (Union County Vol. 223, Pg. 137), S 32°-33'-41" E, a distance of 3719.63 feet to a 5/8 inch iron rod set, passing a 5/8 inch iron rod set on the right-of-way of County Highway 153 at 32.75 feet, a 5/8 inch iron rod set on the northeast corner of Virginia Military Survey 3163 at 76.70 feet, and passing into Union County at 702.61 feet.

THENCE, with the northerly line of the R. Michael Funderburgh and Sandra E. Funderburgh original 150.0 acre tract (Union County Vol. 303, Pg. 19), S 56°-09'-39" W, a distance of 1003.41 feet to a point in the center of Big Darby Creek referenced by a 5/8 inch iron rod set S 56°-09'-39" W, a distance of 35.00 feet, passing a 5/8 inch iron rod set at 958.41 feet.

THENCE, with the center-line of the Big Darby Creek the following seven courses:

N 13°-50'-24" W, a distance of 116.05 feet to a point referenced by a 5/8 inch iron rod set S 77°-26'-58" W, a distance of 30.00 feet.

N 27°-17'-14" W, a distance of 215.62 feet to a point referenced by a 5/8 inch iron rod set S 63°-16'-01" W, a distance of 27.00 feet.

N 14°-25'-55" W, a distance of 49.94 feet to a point referenced by a 5/8 inch iron rod set S 71°-46'-54" W, a distance of 30.00 feet.

N 4°-29'-53" E, a distance of 129.62 feet to a point referenced by a 5/8 inch iron rod set N 88°-30'-30" W, a distance of 35.00 feet.

N 16°-55'-11" E, a distance of 304.01 feet to a point referenced by a 5/8 inch iron rod set N 70°-39'-51" W, a distance of 20.50 feet.

N 4°-50'-37" W, a distance of 203.78 feet to a point referenced by a 5/8 inch iron rod set S 76°-46'-09" W, a distance of 47.00 feet.

N 49°-42'-52" W, a distance of 75.950 feet to a point.

THENCE, N 45°-16'-26" E, a distance of 479.72 feet to a 5/8 inch iron rod set, passing a 5/8 inch iron rod set at 45.00 feet.

THENCE, N 32°-33'-41" W, a distance of 2750.00 feet to a MAG nail set on the center-line of County Highway 153, passing a 5/8 inch iron rod set at 2717.25 feet.

THENCE, with the center-line of County Highway 153, N 81°-06'-55" E, a distance of 87.35 feet to the point of beginning.

Containing 22.440 acres of which 0.060 acre is within the highway right-of-way, 1.422 acres are in Logan County with 0.173 acre in Virginia Military Survey 12256 and 1.249 acres are in Virginia Military Survey 3163, and 21.018 acres are in Virginia Military Survey 3163 in Union County.

The basis for bearings is the center-line of County Highway 153 west of the south line of Virginia Military Survey 12256, being N 81°-06'-55" E, and all other bearings are from angles and distance measured in a field survey by Lee Surveying and Mapping Co., Inc. on July 22, 1998.



ORIGINAL STAMP IN GREEN

Description prepared by:

Jeffrey I. Lee
Professional Surveyor 6359
July 23, 1998

INDEXED ON MAP
748 3D-4

L-2522

VIRGINIA MILITARY SURVEY 4606
VIRGINIA MILITARY SURVEY 12256

VIRGINIA MILITARY SURVEY 4606
COUNTY HIGHWAY 168 (60') STOKES ROAD
VIRGINIA MILITARY SURVEY 4880

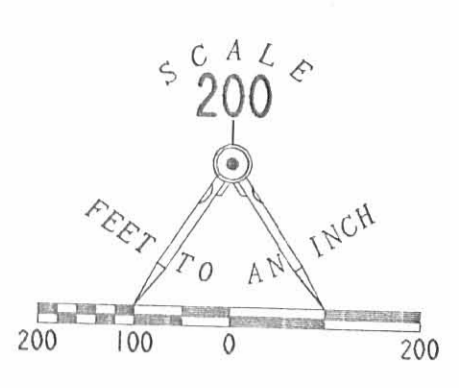

- LEGEND
- 5/8 IRON ROD SET
 - ⊙ MAG NAIL SET
 - ⊕ RAILROAD SPIKE FOUND
 - 5/8 IRON ROD FOUND
 - 1" IRON PIPE FOUND
 - ⊕ 2" IRON PIPE FOUND
 - ⊕ PK NAIL FOUND
 - ⊕ 3/4" SQ. IRON BAR FOUND
 - ⊕ WOOD POST FOUND

NOTE:
BY GRAPHIC PLOTTING ONLY, THE AREA SHOWN IN LOGAN COUNTY IS IN FLOOD ZONE "A", AREA OF 100 YEAR FLOOD AND IN FLOOD ZONE "C", AREA OF MINIMAL FLOODING PER THE FLOOD INSURANCE RATE MAP PANEL NUMBER 390772 0225 C DATED MAY 15, 1985

THE AREA SHOWN IN UNION COUNTY IS IN FLOOD ZONE "AE", SPECIAL FLOOD HAZARD AREA INUNDATED BY 100 YEAR FLOOD BASE LEVEL DETERMINED, AND IN FLOOD ZONE "X", AREA DETERMINED TO BE OUTSIDE 500 YEAR FLOOD PLAIN PER THE FLOOD INSURANCE RATE MAP PANEL NUMBER 390808 0075 B, DATED SEPT. 27, 1991

NO FIELD SURVEYING WAS PERFORMED TO DETERMINE THESE ZONES AND AN ELEVATION CERTIFICATE MAY BE NEEDED TO VERIFY THIS DETERMINATION OR TO APPLY FOR A VARIANCE FROM THE FEDERAL EMERGENCY MANAGEMENT AGENCY.

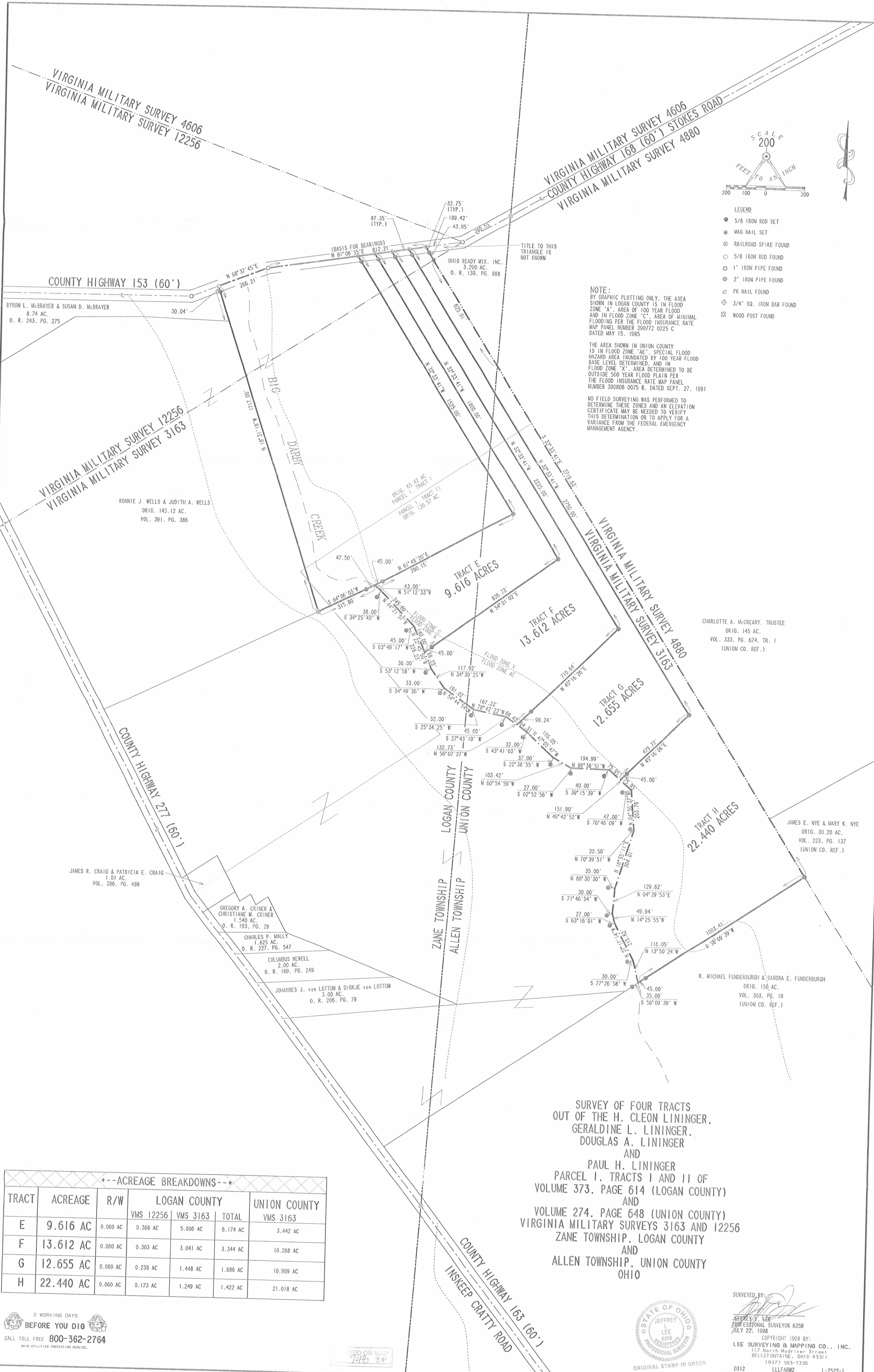

JAMES R. CRAIG & PATRICIA E. CRAIG
1.01 AC.
VOL. 386, PG. 489

GREGORY A. CRINER & CHRISTIANE M. CRINER
1.540 AC.
O. R. 193, PG. 29

CHARLES P. MALLY
1.625 AC.
O. R. 227, PG. 547

COLUMBUS NEWELL
2.00 AC.
O. R. 169, PG. 249

JOHANNES J. von LOTTUM & DIRKJE von LOTTUM
3.00 AC.
O. R. 206, PG. 79

CHARLOTTE A. McCREARY, TRUSTEE
0.145 AC.
VOL. 333, PG. 674, TR. 1
(UNION CO. REF.)

JAMES E. NYE & MARY K. NYE
0.16 AC.
VOL. 223, PG. 137
(UNION CO. REF.)

R. MICHAEL FUNDERBURGH & SANDRA E. FUNDERBURGH
0.150 AC.
VOL. 303, PG. 19
(UNION CO. REF.)

SURVEY OF FOUR TRACTS
OUT OF THE H. CLEON LININGER,
GERALDINE L. LININGER,
DOUGLAS A. LININGER
AND
PAUL H. LININGER
PARCEL I, TRACTS I AND II OF
VOLUME 373, PAGE 614 (LOGAN COUNTY)
AND
VOLUME 274, PAGE 648 (UNION COUNTY)
VIRGINIA MILITARY SURVEYS 3163 AND 12256
ZANE TOWNSHIP, LOGAN COUNTY
AND
ALLEN TOWNSHIP, UNION COUNTY
OHIO

---ACREAGE BREAKDOWNS---

TRACT	ACREAGE	R/W	LOGAN COUNTY			UNION COUNTY
			VMS 12256	VMS 3163	TOTAL	VMS 3163
E	9.616 AC	0.060 AC	0.368 AC	5.806 AC	6.174 AC	3.442 AC
F	13.612 AC	0.060 AC	0.303 AC	3.041 AC	3.344 AC	10.268 AC
G	12.655 AC	0.060 AC	0.238 AC	1.448 AC	1.686 AC	10.969 AC
H	22.440 AC	0.060 AC	0.173 AC	1.249 AC	1.422 AC	21.018 AC

2 WORKING DAYS
BEFORE YOU DIG
CALL TOLL FREE 800-362-2764
OHIO UTILITIES PROTECTION SERVICE

SEED ON MAP
7446 3P



SURVEYED BY:
JEFFREY V. LEE
PROFESSIONAL SURVEYOR 6359
JULY 22, 1998
COPYRIGHT 1998 BY:
LEE SURVEYING & MAPPING CO., INC.
117 North Madison Street
BELLEFONTAINE, OHIO 43311
(937) 593-7335
D312 LLLFARM2 LLLFARMS.DAT L-2522-1

Lee Surveying and Mapping Co., Inc.

Land Surveys • Topography • Subdivisions • Construction Layout

117 N. Madriver St.
Bellefontaine OH 43311



Phone: (937) 593-7335
Fax: (937) 593-7444

COUNTRYTME TRACT A 2.819 ACRES

Lying in Virginia Military Surveys 3163 and 12256, Zane Township, Logan County, Ohio.

Being out of the COUNTRYTME GROVE CITY, LTD. 92.257 acre tract as deeded and described in Official Record 382, Page 134 of the Logan County Records of Deeds and being more particularly described as follows:

Beginning at a 1 inch iron pipe found on the center-line of Logan County Highway 153 at the southeast corner of Virginia Military Survey 12256.

THENCE, with the center-line of County Highway 153 (60 feet wide), S 81°-06'-55" W, a distance of 189.42 feet to a MAG nail set at the TRUE POINT OF BEGINNING, passing a railroad spike found at 36.20 feet.

THENCE, with the west line of the Ohio Ready Mix, Inc. 3.290 acre tract (O.R. 139, Pg. 888), S 32°-33'-41" E, a distance of 500.00 feet to a 5/8 inch iron rod set, passing 5/8 inch iron rods set at 32.42 feet and 76.37 feet.

THENCE, S 71°-51'-16" W, a distance of 250.00 feet to a 5/8 inch iron rod set.

THENCE, N 31°-09'-34" W, a distance of 538.32 feet to a MAG nail set, passing a 5/8 inch iron rod set at 505.90 feet

THENCE, with the center-line of County Highway 153, N 81°-06'-55" E, a distance of 250.00 feet to the point of beginning.

Containing 2.819 acres of which 0.172 acre is within the highway right-of-way, 0.678 acres is in Virginia Military Survey 12256 and 2.141 acres are in Virginia Military Survey 3163.

The basis for bearings is the center-line of County Highway 153 west of the southeast corner of Virginia Military Survey 12256, being N 81°-06'-55" E, and all other bearings are from angles and distance measured in a field survey by Lee Surveying and Mapping Co., Inc. on September 10, 1999.

Description prepared by:

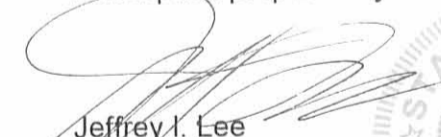
Jeffrey I. Lee
Professional Surveyor 6359
September 10, 1999

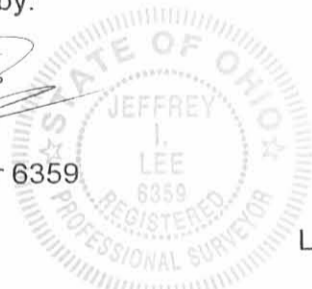

L-2522

ORIGINAL STAMP IN GREEN

INDEXED ON MAP
748 4D-1

Rec'd 9-24-99 11:21

Lee Surveying and Mapping Co., Inc.

Land Surveys • Topography • Subdivisions • Construction Layout

117 N. Madriver St.
Bellefontaine OH 43311



Phone: (937) 593-7335
Fax: (937) 593-7444

COUNTRYTYME TRACT B 3.212 ACRES

Lying in Virginia Military Surveys 3163 and 12256, Zane Township, Logan County, Ohio.

Being out of the COUNTRYTYME GROVE CITY, LTD. 92.257 acre tract as deeded and described in Official Record 382, Page 134 of the Logan County Records of Deeds, and being more particularly described as follows:

Beginning at a 1 inch iron pipe found on the center-line of Logan County Highway 153 at the southeast corner of Virginia Military Survey 12256.

THENCE, with the center-line of County Highway 153 (60 feet wide), S 81°-06'-55" W, a distance of 439.42 feet to a MAG nail set at the TRUE POINT OF BEGINNING, passing a railroad spike found at 36.20 feet.

THENCE, S 31°-09'-34" E, a distance of 538.32 feet to a 5/8 inch iron rod set, passing a 5/8 inch iron rod set at 32.42 feet.

THENCE, S 71°-51'-16" W, a distance of 275.00 feet to a 5/8 inch iron rod set.

THENCE, N 27°-29'-37" W, a distance of 572.32 feet to a MAG nail set, passing a 5/8 inch iron rod set at 540.67 feet

THENCE, with the center-line of County Highway 153, N 81°-06'-55" E, a distance of 250.00 feet to the point of beginning.

Containing 3.212 acres of which 0.173 acre is within the highway right-of-way, 1.272 acres are in Virginia Military Survey 12256 and 1.940 acres are in Virginia Military Survey 3163.

The basis for bearings is the center-line of County Highway 153 west of the southeast corner of Virginia Military Survey 12256, being N 81°-06'-55" E, and all other bearings are from angles and distance measured in a field survey by Lee Surveying and Mapping Co., Inc. on September 10, 1999.

Description prepared by:

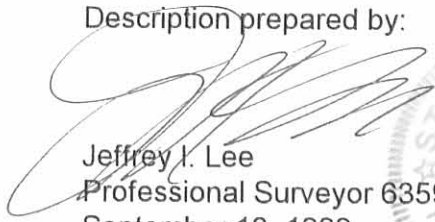
Jeffrey I. Lee
Professional Surveyor 6359
September 10, 1999

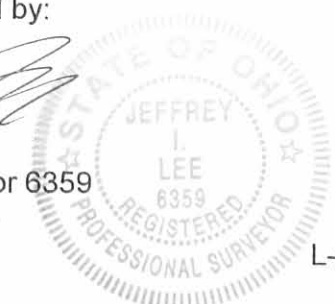

L-2522

ORIGINAL STAMP IN GREEN

INDEXED ON MAP
798 4D-2

Lee Surveying and Mapping Co., Inc.

Land Surveys • Topography • Subdivisions • Construction Layout

117 N. Madriver St.
Bellefontaine OH 43311



Phone: (937) 593-7335
Fax: (937) 593-7444

COUNTRYTYME TRACT C 3.298 ACRES

Lying in Virginia Military Surveys 3163 and 12256, Zane Township, Logan County, Ohio.

Being out of the COUNTRYTYME GROVE CITY, LTD. 92.257 acre tract as deeded and described in Official Record 382, Page 134 of the Logan County Records of Deeds, and being more particularly described as follows:

Beginning at a 1 inch iron pipe found on the center-line of Logan County Highway 153 at the southeast corner of Virginia Military Survey 12256.

THENCE, with the center-line of County Highway 153 (60 feet wide), S 81°-06'-55" W, a distance of 689.42 feet to a MAG nail set at the TRUE POINT OF BEGINNING, passing a railroad spike found at 36.20 feet.

THENCE, S 27°-29'-37" E, a distance of 572.32 feet to a 5/8 inch iron rod set, passing a 5/8 inch iron rod set at 31.65 feet.

THENCE, S 71°-51'-16" W, a distance of 275.00 feet to a 5/8 inch iron rod set.

THENCE, N 21°-57'-24" W, a distance of 602.26 feet to a MAG nail set, passing a 5/8 inch iron rod set at 571.46 feet

THENCE, with the center-line of County Highway 153, N 81°-06'-55" E, a distance of 225.00 feet to the point of beginning.

Containing 3.298 acres of which 0.156 acre is within the highway right-of-way, 1.752 acres are in Virginia Military Survey 12256 and 1.546 acres are in Virginia Military Survey 3163.

The basis for bearings is the center-line of County Highway 153 west of the southeast corner of Virginia Military Survey 12256, being N 81°-06'-55" E, and all other bearings are from angles and distance measured in a field survey by Lee Surveying and Mapping Co., Inc. on September 10, 1999.

Description prepared by:

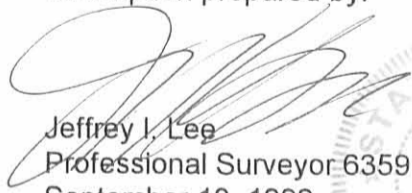
Jeffrey I. Lee
Professional Surveyor 6359
September 10, 1999



L-2522

ORIGINAL STAMP IN GREEN

INDEXED ON MAP
748 4D-3

Lee Surveying and Mapping Co., Inc.

Land Surveys • Topography • Subdivisions • Construction Layout

117 N. Madriver St.
Bellefontaine OH 43311



Phone: (937) 593-7335
Fax: (937) 593-7444

COUNTRYTYME TRACT D 5.157 ACRES

Lying in Virginia Military Surveys 3163 and 12256, Zane Township, Logan County, Ohio.

Being out of the COUNTRYTYME GROVE CITY, LTD. 92.257 acre tract as deeded and described in Official Record 382, Page 134 of the Logan County Records of Deeds, and being more particularly described as follows:

Beginning at a 1 inch iron pipe found on the center-line of Logan County Highway 153 at the southeast corner of Virginia Military Survey 12256.

THENCE, with the center-line of County Highway 153 (60 feet wide), S 81°-06'-55" W, a distance of 914.42 feet to a MAG nail set at the TRUE POINT OF BEGINNING, passing a railroad spike found at 36.20 feet.

THENCE, S 21°-57'-24" E, a distance of 602.26 feet to a 5/8 inch iron rod set, passing a 5/8 inch iron rod set at 30.80 feet.

THENCE, S 71°-51'-16" W, a distance of 387.95 feet to a 5/8 inch iron rod set.

THENCE, with the east lines of the Douglas K. Henry 134.38 acre tract (Vol. 405, Pg. 685) and the Byron L. McBrayer 8.740 acre tract (O.R. 243, Pg. 275), N 18°-31'-18" W, a distance of 600.00 feet to a P.K. nail found, passing a 5/8 inch iron rod set at 569.96 feet

THENCE, with the center-line of County Highway 153, N 68°-37'-45" E, a distance of 266.21 feet to a 1 inch iron pipe found.

THENCE, with the center-line of County Highway 153, N 81°-06'-55" E, a distance of 87.21 feet to the point of beginning.

Containing 5.157 acres of which 0.223 acre is within the highway right-of-way, 3.609 acres are in Virginia Military Survey 12256 and 1.548 acres are in Virginia Military Survey 3163.

The basis for bearings is the center-line of County Highway 153 west of the southeast corner of Virginia Military Survey 12256, being N 81°-06'-55" E, and all other bearings are from angles and distance measured in a field survey by Lee Surveying and Mapping Co., Inc. on September 10, 1999.

Description prepared by:

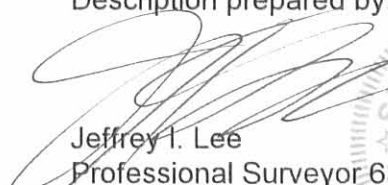
Jeffrey I. Lee
Professional Surveyor 6359
September 10, 1999

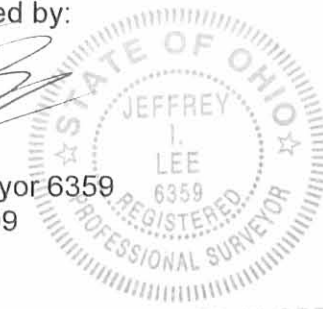

L-2522

ORIGINAL STAMP IN GREEN

INDEXED ON MAP
748 4D-4

Lee Surveying and Mapping Co., Inc.

Land Surveys • Topography • Subdivisions • Construction Layout

117 N. Madriver St.
Bellefontaine OH 43311



Phone: (937) 593-7335
Fax: (937) 593-7444

COUNTRYTYME EASEMENT OVER TRACT D

Lying in Virginia Military Surveys 3163 and 12256, Zane Township, Logan County, Ohio.

Being an easement over the COUNTRYTYME GROVE CITY, LTD. 92.257 acre tract as deeded and described in Official Record 382, Page 134 of the Logan County Records of Deeds, and being more particularly described as follows:

Beginning at a 1 inch iron pipe found on the center-line of Logan County Highway 153 at the southeast corner of Virginia Military Survey 12256.

THENCE, with the center-line of County Highway 153 (60 feet wide), S 81°-06'-55" W, a distance of 1001.63 feet to a 1 inch iron pipe found, passing a railroad spike found at 36.20 feet.

THENCE, with the center-line of County Highway 153, S 68°-37'-45" W, a distance of 33.38 feet to a point at the TRUE POINT OF BEGINNING.

THENCE, S 15°-28'-55" E, a distance of 613.75 feet to a point.

THENCE, S 71°-51'-16" W, a distance of 200.00 feet to a 5/8 inch iron rod set.

THENCE, with the east lines of the Douglas K. Henry 134.38 acre tract (Vol. 405, Pg. 685) and the Byron L. McBrayer 8.740 acre tract (O.R. 243, Pg. 275), N 18°-31'-18" W, a distance of 600.00 feet to a P.K. nail found, passing a 5/8 inch iron rod set at 569.96 feet

THENCE, with the center-line of County Highway 153, N 68°-37'-45" E, a distance of 232.83 feet to the point of beginning.

Containing 3.009 acres.

The basis for bearings is the center-line of County Highway 153 west of the southeast corner of Virginia Military Survey 12256, being N 81°-06'-55" E, and all other bearings are from angles and distance measured in a field survey by Lee Surveying and Mapping Co., Inc. on September 10, 1999.



Description prepared by:

A handwritten signature in black ink, appearing to read 'Jeffrey I. Lee', written over a large, light-colored scribble.
Jeffrey I. Lee
Professional Surveyor 6359
September 10, 1999
Revised October 1, 1999

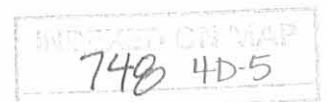

- RCD 9-24-99 OKGCH

Lee Surveying and Mapping Co., Inc.

Land Surveys • Topography • Subdivisions • Construction Layout

117 N. Madriver St.
Bellefontaine OH 43311



Phone: (937) 593-7335
Fax: (937) 593-7444

COUNTRYTYME 77.771 ACRES

Lying in Virginia Military Survey 3163, Zane Township, Logan County, and Allen Township, Union County, Ohio

Being out of the COUNTRYTYME GROVE CITY, LTD. 92.257 acre tract as deeded and described in Official Record 382, Page 134 of the Logan County Records of Deeds, and Official Record 143, Page 400 of the Union County Records of Deeds and being more particularly described as follows:

Beginning at a 1 inch iron pipe found on the center-line of Logan County Highway 153 at the southeast corner of Virginia Military Survey 12256.

THENCE, with the center-line of County Highway 153 (60 feet wide), S 81°-06'-55" W, a distance of 189.42 feet to a MAG nail set, passing a railroad spike found at 36.20 feet.

THENCE, with the west line of the Ohio Ready Mix, Inc. 3.290 acre tract (Logan County O.R. 139, Pg. 888,), S 32°-33'-41" E, a distance of 500.00 feet to a 5/8 inch iron rod set at the TRUE POINT OF BEGINNING, passing 5/8 inch iron rods set at 32.42 feet and 76.37 feet.

THENCE, with the west lines of the said 3.290 acre tract, the Charlotte A McCreary, Trustee original 145.0 acre tract (Union County Vol. 333, Pg. 674, Tr. I), and the James E. Nye and Mary K. Nye original 30.20 acre tract (Union County Vol. 223, Pg. 137), S 32°-33'-41" E, a distance of 3219.63 feet to a 5/8 inch iron rod set, passing into Union County.

THENCE, with the northerly line of the R. Michael Funderburgh and Sandra E. Funderburgh original 150.0 acre tract (Union County Vol. 303, Pg. 19), S 56°-09'-39" W, a distance of 1003.41 feet to a point in the center of Big Darby Creek, passing a 5/8 inch iron rod set for reference at 958.41 feet.

THENCE, with the east line of the H. Cleon Lininger, Etal's original 128.75 acre tract (Logan County Vol. 373, Pg. 614, Parcel I, Tract II) (Union County Vol. 274, Pg. 648) and with the center-line of the Big Darby Creek the following eleven courses:

N 13°-50'-24" W, a distance of 116.05 feet to a point referenced by a 5/8 inch iron rod set
S 77°-26'-58" W, a distance of 30.00 feet.

N 27°-17'-14" W, a distance of 215.62 feet to a point referenced by a 5/8 inch iron rod set
S 63°-16'-01" W, a distance of 27.00 feet.

N 14°-25'-55" W, a distance of 49.94 feet to a point referenced by a 5/8 inch iron rod set
S 71°-46'-54" W, a distance of 30.00 feet.

N 4°-29'-53" E, a distance of 129.62 feet to a point referenced by a 5/8 inch iron rod set
N 88°-30'-30" W, a distance of 35.00 feet.

N 16°-55'-11" E, a distance of 304.01 feet to a point referenced by a 5/8 inch iron rod set
N 70°-39'-51" W, a distance of 20.50 feet.

N 4°-50'-37" W, a distance of 203.78 feet to a point referenced by a 5/8 inch iron rod set
S 76°-46'-09" W, a distance of 47.00 feet.

N 49°-42'-52" W, a distance of 151.90 feet to a point referenced by a 5/8 inch iron rod set
S 39°-15'-39" W, a distance of 40.00 feet.

N 88°-38'-51" W, a distance of 194.99 feet to a point referenced by a 5/8 inch iron rod set
S 2°-52'-56" W, a distance of 27.00 feet.

N 60°-54'-59" W, a distance of 103.42 feet to a point reference by a 5/8 inch iron rod set
S 22°-38'-55" W, a distance of 37.00 feet.

INDEXED ON MAP
748 406

Lee Surveying and Mapping Co., Inc.

Land Surveys • Topography • Subdivisions • Construction Layout

117 N. Madriver St.
Bellefontaine OH 43311



Phone: (937) 593-7335
Fax: (937) 593-7444

N 47°-05'-47" W, a distance of 186.05 feet to a point reference by a 5/8 inch iron rod set
S 43°-41'-03" W, a distance of 32.00 feet.

N 56°-07'-27" W, a distance of 132.73 feet to a point reference by a 5/8 inch iron rod set
S 27°-43'-10" W, a distance of 45.00 feet.

THENCE, with the east line of said 128.75 acre tract and the east line of H. Cleon Lininger, Etal's original 208.54 acre tract (Logan County Vol. 373, Pg. 614, Parcel I, Tract I) (Union County Vol. 274, Pg. 648), and continuing with the center-line of the Big Darby Creek, N 78°-42'-22" W, a distance of 167.22 feet to a point reference by a 5/8 inch iron rod set S 25°-34'-25" W, a distance of 32.00 feet.

THENCE, with the east line of said original 208.54 acre tract and the center-line of the Big Darby Creek the following 5 courses:

N 54°-44'-54" W, a distance of 191.02 feet to a point reference by a 5/8 inch iron rod set
S 34°-49'-36" W, a distance of 33.00 feet, passing into Logan County.

N 34°-30'-25" W, a distance of 117.92 feet to a point reference by a 5/8 inch iron rod set
S 53°-12'-58" W, a distance of 36.00 feet.

N 23°-45'-50" W, a distance of 228.23 feet to a point reference by a 5/8 inch iron rod set
S 63°-49'-17" W, a distance of 45.00 feet.

N 44°-21'-57" W, a distance of 245.69 feet to a point reference by a 5/8 inch iron rod set
S 34°-25'-40" W, a distance of 38.00 feet.

N 51°-12'-33" W, a distance of 43.00 feet to a point.

THENCE, with the north line of said original 208.54 acre tract, S 64°-06'-03" W, a distance of 315.80 feet to a 2 inch iron pipe found, passing a 5/8 inch iron rod set at 47.50 feet.

THENCE, with the easterly lines of the Douglas K. Henry and Dana L. Henry 134.38 acre tract (Vol. 405, Pg. 685), N 18°-31'-18" W, a distance of 1117.00 feet to a 5/8 inch iron rod set.

THENCE, N 71°-51'-16" E, a distance of 1187.95 feet to the point of beginning.

Containing 77.771 acres of which 46.190 acres are in Union County, and 31.581 acres are in Logan County.

The basis for bearings is the center-line of County Highway 153 at the northeast corner of the subject property is N 81°-06'-55" E, and all other bearings are from angles and distances measured in a field survey by Lee Surveying and Mapping Co., Inc. on September 10, 1999.

Description prepared by:

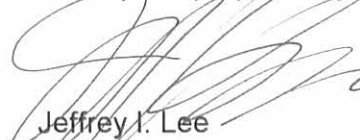
Jeffrey I. Lee
Professional Surveyor 6359
September 10, 1999



ORIGINAL STAMP IN GREEN L 2522

748 4D-7

REV 9-24-99

VIRGINIA MILITARY SURVEY 4606
VIRGINIA MILITARY SURVEY 12256

VIRGINIA MILITARY SURVEY 4606
UNION COUNTY HIGHWAY 168 (60') STOKES ROAD
VIRGINIA MILITARY SURVEY 4880

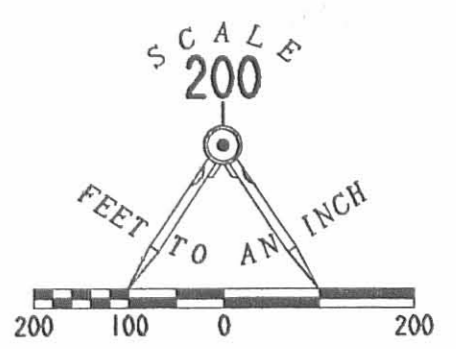

- LEGEND
- 5/8" IRON ROD SET
 - ⊙ MAG NAIL SET
 - ⊗ RAILROAD SPIKE FOUND
 - 5/8" IRON ROD FOUND
 - 1" IRON PIPE FOUND
 - ⊗ 2" IRON PIPE FOUND
 - ⊙ PK NAIL FOUND
 - ⊕ 3/4" SQ. IRON BAR FOUND
 - ⊗ WOOD POST FOUND

NOTE:
BY GRAPHIC PLOTTING ONLY, THE AREA SHOWN IN LOGAN COUNTY IS IN FLOOD ZONE "A", AREA OF 100 YEAR FLOOD AND IN FLOOD ZONE "C", AREA OF MINIMAL FLOODING PER THE FLOOD INSURANCE RATE MAP PANEL NUMBER 390772 0225 C DATED MAY 15, 1985

THE AREA SHOWN IN UNION COUNTY IS IN FLOOD ZONE "AE", SPECIAL FLOOD HAZARD AREA INUNDATED BY 100 YEAR FLOOD BASE LEVEL DETERMINED, AND IN FLOOD ZONE "X", AREA DETERMINED TO BE OUTSIDE 500 YEAR FLOOD PLAIN PER THE FLOOD INSURANCE RATE MAP PANEL NUMBER 390806 0075 B, DATED SEPT. 27, 1991

NO FIELD SURVEYING WAS PERFORMED TO DETERMINE THESE ZONES AND AN ELEVATION CERTIFICATE MAY BE NEEDED TO VERIFY THIS DETERMINATION OR TO APPLY FOR A VARIANCE FROM THE FEDERAL EMERGENCY MANAGEMENT AGENCY.

--ACREAGE BREAKDOWNS--				
TRACT	ACREAGE	R/W	LOGAN COUNTY	
			VMS 12256	VMS 3163
A	2.819 AC	0.172 AC	0.678 AC	2.141 AC
B	3.212 AC	0.173 AC	1.272 AC	1.940 AC
C	3.298 AC	0.156 AC	1.752 AC	1.546 AC
D	5.157 AC	0.223 AC	3.609 AC	1.548 AC

LOGAN COUNTY HIGHWAY 153 (60')

BYRON L. McBRAYER & SUSAN D. McBRAYER
8.740 AC.
O. R. 243, PG. 275

VIRGINIA MILITARY SURVEY 12256
VIRGINIA MILITARY SURVEY 3163

DOUGLAS K. HENRY & DANA L. HENRY
134.38 AC.
VOL. 405, PG. 685

COUNTRYTYME, GROVE CITY, LTD.
92.257 ACRES
O.R. 382, PG. 134 (LOGAN COUNTY)

31.581 ACRES
46.190 ACRES

77.771 ACRES

VIRGINIA MILITARY SURVEY 4880
VIRGINIA MILITARY SURVEY 3163

COUNTRYTYME, GROVE CITY, LTD.
92.257 ACRES
O.R. 143, PG. 400 (UNION COUNTY)

H. CLEON LININGER & GERALDINE L. LININGER & DOUGLAS ALLEN LININGER & PAUL HOWARD LININGER
ORIG. 208.54 ACRE TRACT
VOL. 373, PG. 614
PARCEL I, TRACT I
VOL. 274, PG. 648 (UNION COUNTY)

H. CLEON LININGER & GERALDINE L. LININGER & DOUGLAS ALLEN LININGER & PAUL HOWARD LININGER
ORIG. 128.75 ACRE TRACT
VOL. 373, PG. 614
PARCEL I, TRACT II
VOL. 274, PG. 648 (UNION COUNTY)

JAMES R. CRAIG & PATRICIA E. CRAIG
1.01 AC.
VOL. 386, PG. 489

GREGORY A. CRINER & CHRISTIANE M. CRINER
1.540 AC.
O. R. 193, PG. 29

CHARLES P. MALLY
1.625 AC.
O. R. 227, PG. 547

COLUMBUS NEWELL
2.00 AC.
O. R. 169, PG. 249

JOHANNES J. von LOTTUM & DIRKJE von LOTTUM
3.00 AC.
O. R. 206, PG. 79

CHARLOTTE A. McCREARY, TRUSTEE
ORIG. 145 AC.
VOL. 333, PG. 674, TR. I
(UNION CO. REF.)

JAMES E. NYE & MARY K. NYE
ORIG. 30.20 AC.
VOL. 223, PG. 137
(UNION CO. REF.)

R. MICHAEL FUNDERBURGH & SANDRA E. FUNDERBURGH
ORIG. 150 AC.
VOL. 303, PG. 19
(UNION CO. REF.)

SURVEY OF FIVE TRACTS
OUT OF THE
COUNTRYTYME, GROVE CITY, LTD.
92.257 ACRES
OFFICIAL RECORD 382, PAGE 134 (LOGAN COUNTY)
COUNTRYTYME, GROVE CITY, LTD.
92.257 ACRES
OFFICIAL RECORD 143, PAGE 400 (UNION COUNTY)
VIRGINIA MILITARY SURVEYS 3163 AND 12256
ZANE TOWNSHIP, LOGAN COUNTY
AND
ALLEN TOWNSHIP, UNION COUNTY
OHIO

INDEXED ON MAP
148 4P

2 WORKING DAYS
BEFORE YOU DIG
CALL TOLL FREE 800-362-2764
OHIO UTILITIES PROTECTION SERVICE.



SURVEYED BY:
JEFFREY L. LEE
PROFESSIONAL SURVEYOR 6359
SEPTEMBER 10, 1999
COPYRIGHT 1999 BY:
LEE SURVEYING & MAPPING CO., INC.
117 North Madriver Street
BELLEFONTAINE, OHIO 43311
(937) 593-7335

ORIGINAL STAMP IN GREEN

D354

LLLFARMS
LLLFARMS.DAT

L-2522-1

REC'D 8-1-00 SWM/OK

Lee Surveying and Mapping Co., Inc.

Land Surveys • Topography • Subdivisions • Construction Layout

117 N. Madriver St.
Bellefontaine OH 43311



Phone: (937) 593-7335
Fax: (937) 593-7444

COUNTRYTYME EASEMENT OVER TRACT D

Lying in Virginia Military Surveys 3163 and 12256, Zane Township, Logan County, Ohio.

Being an easement over the COUNTRYTYME GROVE CITY, LTD. 5.157 acre tract as deeded and described in Official Record 433, Page 422 of the Logan County Records of Deeds, and being more particularly described as follows:

Beginning at a 1 inch iron pipe found on the center-line of Logan County Highway 153 at the southeast corner of Virginia Military Survey 12256.

THENCE, with the center-line of County Highway 153 (60 feet wide), S 81°-06'-55" W, a distance of 1001.63 feet to a 1 inch iron pipe found, passing a railroad spike found at 36.20 feet.

THENCE, with the center-line of County Highway 153, S 68°-37'-45" W, a distance of 33.38 feet to a point at the TRUE POINT OF BEGINNING.

THENCE, S 11°-18'-26" E, a distance of 617.48 feet to a point.

THENCE, S 71°-51'-16" W, a distance of 155.00 feet to a 5/8 inch iron rod set.

THENCE, with the east lines of the Douglas K. Henry 134.38 acre tract (Vol. 405, Pg. 685) and the Byron L. McBryer 8.740 acre tract (O.R. 243, Pg. 275), N 18°-31'-18" W, a distance of 600.00 feet to a P.K. nail found, passing a 5/8 inch iron rod set at 569.96 feet

THENCE, with the center-line of County Highway 153, N 68°-37'-45" E, a distance of 232.83 feet to the point of beginning.

Containing 2.692 acres.

The basis for bearings is the center-line of County Highway 153 west of the southeast corner of Virginia Military Survey 12256, being N 81°-06'-55" E, and all other bearings are from angles and distance measured in a field survey by Lee Surveying and Mapping Co., Inc. on September 10, 1999.

Description prepared by:

William K. Bruce
Professional Surveyor 7437
September 10, 1999
Revised July 26, 2000



ORIGINAL STAMP IN GREEN

L-2522

INDEXED ON MAP
748 5D

VIRGINIA MILITARY SURVEY 4606
 VIRGINIA MILITARY SURVEY 12256

VIRGINIA MILITARY SURVEY 4606
 UNION COUNTY HIGHWAY 168 (60') STOKES ROAD
 VIRGINIA MILITARY SURVEY 4880

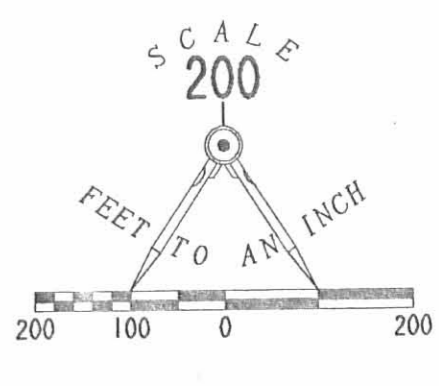

LOGAN COUNTY HIGHWAY 153 (60')

BYRON L. McBRAYER & SUSAN D. McBRAYER
 8.740 AC.
 O. R. 243, PG. 275

EASEMENT

VIRGINIA MILITARY SURVEY 12256
 VIRGINIA MILITARY SURVEY 3163

DOUGLAS K. HENRY & DANA L. HENRY
 134.38 AC.
 VOL. 405, PG. 685

COUNTRYTYME, GROVE CITY, LTD.
 92.257 ACRES
 O. R. 382, PG. 134 (LOGAN COUNTY)

NOTE:
 THE AREA SHOWN IN UNION COUNTY IS IN FLOOD ZONE "AE". SPECIAL FLOOD HAZARD AREA INUNDATED BY 100 YEAR FLOOD BASE LEVEL DETERMINED, AND IN FLOOD ZONE "X". AREA DETERMINED TO BE OUTSIDE 500 YEAR FLOOD PLAIN PER THE FLOOD INSURANCE RATE MAP PANEL NUMBER 390772 0225 C DATED MAY 15, 1985

THE AREA SHOWN IN LOGAN COUNTY IS IN FLOOD ZONE "A". AREA OF 100 YEAR FLOOD AND IN FLOOD ZONE "C". AREA OF MINIMAL FLOODING PER THE FLOOD INSURANCE RATE MAP PANEL NUMBER 390772 0225 C DATED MAY 15, 1985

NO FIELD SURVEYING WAS PERFORMED TO DETERMINE THESE ZONES AND AN ELEVATION CERTIFICATE MAY BE NEEDED TO VERIFY THIS DETERMINATION OR TO APPLY FOR A VARIANCE FROM THE FEDERAL EMERGENCY MANAGEMENT AGENCY.

--ACREAGE BREAKDOWNS--

TRACT	ACREAGE	R/W	LOGAN COUNTY	
			VMS 12256	VMS 3163
A	2.819 AC	0.172 AC	0.678 AC	2.141 AC
B	3.212 AC	0.173 AC	1.272 AC	1.940 AC
C	3.298 AC	0.156 AC	1.752 AC	1.546 AC
D	5.157 AC	0.223 AC	3.609 AC	1.548 AC

31.581 ACRES
 46.190 ACRES

77.771 ACRES

COUNTRYTYME, GROVE CITY, LTD.
 92.257 ACRES
 O. R. 143, PG. 400 (UNION COUNTY)

CHARLOTTE A. McCREARY, TRUSTEE
 ORIG. 145 AC.
 VOL. 333, PG. 674, TR. 1
 (UNION CO. REF.)

H. CLEON LININGER & GERALDINE L. LININGER & DOUGLAS ALLEN LININGER & PAUL HOWARD LININGER
 ORIG. 208.54 ACRE TRACT
 VOL. 373, PG. 614
 PARCEL I, TRACT I
 VOL. 274, PG. 648 (UNION COUNTY)

H. CLEON LININGER & GERALDINE L. LININGER & DOUGLAS ALLEN LININGER & PAUL HOWARD LININGER
 ORIG. 128.75 ACRE TRACT
 VOL. 373, PG. 614
 PARCEL I, TRACT II
 VOL. 274, PG. 648 (UNION COUNTY)

JAMES R. CRAIG & PATRICIA E. CRAIG
 1.01 AC.
 VOL. 386, PG. 489

GREGORY A. CRINER & CHRISTIANE M. CRINER
 1.540 AC.
 O. R. 193, PG. 29

CHARLES P. MALLY
 1.625 AC.
 O. R. 227, PG. 547

COLUMBUS NEWELL
 2.00 AC.
 O. R. 169, PG. 249

JOHANNES J. von LOTTUM & DIRKJE von LOTTUM
 3.00 AC.
 O. R. 206, PG. 79

JAMES E. NYE & MARY K. NYE
 ORIG. 30.20 AC.
 VOL. 223, PG. 137
 (UNION CO. REF.)

R. MICHAEL FUNDERBURGH & SANDRA E. FUNDERBURGH
 ORIG. 150 AC.
 VOL. 303, PG. 19
 (UNION CO. REF.)

SURVEY OF FIVE TRACTS
 OUT OF THE
 COUNTRYTYME, GROVE CITY, LTD.
 92.257 ACRES
 OFFICIAL RECORD 382, PAGE 134 (LOGAN COUNTY)
 COUNTRYTYME, GROVE CITY, LTD.
 92.257 ACRES
 OFFICIAL RECORD 143, PAGE 400 (UNION COUNTY)
 VIRGINIA MILITARY SURVEYS 3163 AND 12256
 ZANE TOWNSHIP, LOGAN COUNTY
 AND
 ALLEN TOWNSHIP, UNION COUNTY
 OHIO



SURVEYED BY
 WILLIAM K. BRUCE
 PROFESSIONAL SURVEYOR 7437
 SEPTEMBER 10, 1999
 REVISED JULY 26, 2000

COPYRIGHT 2000 BY:
 LEE SURVEYING & MAPPING CO., INC.
 117 North Madriver Street
 BELLEFONTAINE, OHIO 43311
 (937) 593-7335

2 WORKING DAYS
BEFORE YOU DIG
 CALL TOLL FREE 800-362-2764
 OHIO UTILITIES PROTECTION SERVICE.

INDEXED ON MAP
 748 5P

D354 LLLFARMS LLLFARMS.DAT L-2522-1

Chas. J. Cooper Survey Zane Tp
Logan Co. & Allen Tp. Union Co.

Earl Shipely Bellefontaine } ch
Frank Arthur Middleburg }
Chas Cooper. Flag.

Corn. at stone west side of Col. &
Zanesfield pike S E L W M S. Huffman.
Found stone near old brick house East
of pike.

Chained N 24 1/4 W 9.49 ch to + pike &
Newton Road.

Thence with @ Newton Road.
N 89 1/2 E 23.38 ch, N 68 1/2 E 5.65 chs
an N 8 1/2 E 11.46 chs to Huber land.

Thence S. 32 1/2 E. 15.68 chs with Huber West
line & East line Survey 3165 to stone

Thence with fence S. 56 W 21.20 chs
Crossing East bank Darby Ck at 17.8 ch

Thence with fence S 41 1/2 E 16.5 chs
to L post

Thence S. 56 1/2 W with old fence
22.65 chs to @ Col. & Zanesfield pike

Thence with @ pike S. 37 1/4 E. 2.81 chs
to L Elisha Congills.

Thence S. 58 1/4 W. 20.72 chs to post near
a cement Anchor post. L Snuffin's line

Survey 12256 & 3163
3/13/13

Thence with Snuffin's East line
N 37 W 34.78 ch. to iron bar @
West Liberty pike, passing a stone
on line at about half way.

Thence with @ W. Liberty pike
N 57 1/2 E 25.78 chs to + W. L. &
Col. & Zanesfield pike, passing a
stone on line at S. vr. L Deborah
Seamans & Acres lot 17.65 1/2 chs.

Thence with @ Col. & Zanesfield pike
N 24 1/4 W. 9.94 chs to beg.

